











# Papyrus Viscom

Prijslijst / Liste de prix  
Februari / Février 2020



**PAPYRUS**   
Your partner in Visual Communication















## Pricelist icons

	grammage per m <sup>2</sup> grammage par m <sup>2</sup>		rol lengte (m) longueur rouleau (m)		verdwijnt uit het gamma sort de l'assortiment
	dikte épaisseur		rol breedte (cm) largeur rouleau (cm)		verpakt per 2 rollen emballé par 2 rouleaux
	duurzaamheid (in jaar) durabilité (en année)		lijm colle		heldere lijm colle claire
	euro per m <sup>2</sup> euro par m <sup>2</sup>		ingeriemd enramé		grijze lijm colle grise
	euro per rol euro par rouleau		bulk pallet palette non-enramé		zwarte lijm colle noire
	as van den rol axe du rouleau				levertijd op aanvraag délais sur demande







## Application icons

	voertuig decoratie décoration de véhicules		display		poster & billboard poster et affiches
	binnentoepassing application intérieure		CAD toepassing applications CAD		foto's photos
	buitentoepassing application extérieure		kaarten cartographie		laminaat laminats
	signs signalétique		presentaties rapports		creatieve toepassingen applications créatives
	raamdecoratie décoration fenêtre		grafische kunsten art graphique		banners bâches
	events événements		flex		proofing épreuve

## Property icons

	zwart-wit noir-blanc		vlak plane		niet krullend bon aplat
	kleuren couleurs		licht gebogen opp. courbes simples		norm brandwerend B1 norme anti-feu B1
	metaalkleuren couleurs métalliques		ondiepe profielen rainures peu profondes		norm brandwerend M1 norme anti-feu M1
	microperf. 50-50		complexe profielen rainures complexes		
	microperf. 60-40 (60 % film)		klinknagels parties rivetées		
	microperf. 70-30 (70 % film)		diepe profielen rainures profondes		

## Inktype icons

	waterb. inkt op waterbasis encre à base d'eau		solv. inkt op basis van solventen encre à base solvant		Dry Toner
	uv UV inkt encre UV		eco solv. inkt op basis van eco/mild solvent encre à base eco/mild solvant		Toner Pearl printers imprimantes Toner Pearl
	latex latex inkt encre latex				

## Environment icons

	Recycleerbaar Recyclable		beantwoordt aan de Reachnorm respecte la norme Reach		FSC® milieucertificaat certificat environnement
	Recycleerbaar met polyethyleen Recyclable avec polyéthylène		ecologisch product produit écologique		
	Recycleerbaar met polyprop. Recyclable avec polyprop.				

## Papyrus Viscom... uw partner in Visuele Communicatie!

Sinds de overname van XL Graphics in oktober 2011 en mede dankzij de kennis die op het vlak van hardware en software die daarmee in huis werd gehaald heeft Papyrus zijn positie in de groot formaat print & sign markt verder kunnen verstevigen. Na een succesvolle integratie van **XL Graphics** met de bestaande LFP, Sign en Screen afdeling van Papyrus België was de volgende stap een logisch gevolg. De krachten van Papyrus en XL Graphics werden verder gebundeld in één krachtig concept met de nieuwe naam: **Papyrus Viscom**.

Door het samenvoegen van beide bedrijven, elk met hun specifieke kennis en ervaring, is Papyrus Viscom een ware specialist geworden op het gebied van totaaloplossingen voor de grootformaat Print & Sign-industrie.

Papyrus Viscom biedt een breed en gevarieerd assortiment van onder meer:

**Grootformaat printers - Snijplotters en snijtafels - Software - Afwerkingsapparatuur - Printmedia - Snijfolies en toebehoren - Trainingen - Eigen dienst-na-verkoop**

Bij Papyrus Viscom krijgen de klanten één enkele, handige bron voor een breed scala aan producten.

Met de Mutoh en Canon printers aangevuld met de Summa snijplotters en snijtafels, heeft Papyrus Viscom een oplossing in huis voor elke Print en/of Cut toepassing. Wij bieden een uitgebreid media-aanbod met sterkhouders als Avery, Hexis, Dickson, RTape, Yupo, Kodak, Chromaluxe en het huismerk Opti. Tevens is er een ruim aanbod aan randapparatuur met o.a. de Roll-X applicatietafels, Neolt snijtafels en Kala laminatoren in combinatie met een doorgedreven kennis van professionele RIP's zoals SAi, Onyx, Caldera. Dit maakt Papyrus Viscom een echte totaalleverancier voor de print- en signmarkt.

In deze prijslijst kan u kennis maken met onze producten. De handige inhoudstafel geeft u een overzicht van ons assortiment. Naast de informatie die u in deze prijslijst kan terugvinden kan u uiteraard ook steeds bij ons team terecht voor bijkomende uitleg. Zij zullen u graag bijstaan met advies over onze producten en hun toepassingen.

We hopen dat deze prijslijst, naast onze website en in combinatie met ons persoonlijk advies een stap in de goede richting is om u te informeren.

We danken u alvast voor het vertrouwen en wensen u bijzonder succesvolle zaken toe.

Met vriendelijke groeten,

Het Papyrus Viscom Team

## Contact

### Papyrus Viscom

Oude Baan 1A - Industriepark - Mechelen-Noord (G) - 2800 Mechelen

Tel.: +32 15 40 50 40 - Fax: +32 15 40 50 49 - E-mail: [viscom.be@papyrus.com](mailto:viscom.be@papyrus.com)

### Papyrus Hoofdkantoor/Siège principal

Internationalelaan 55 b 33 - Bld International 55 b 33 - 1070 Brussel - Bruxelles

Tel.: nl: +32 2 529 85 79 - fr: +32 2 529 85 80 - Fax +32 2 520 38 93 - E-mail: [viscom.be@papyrus.com](mailto:viscom.be@papyrus.com)

### Papyrus Magazijn/Magasin

Noorderstraat 2 - 1502 Halle-Lembeek

## Papyrus Viscom, votre partenaire en Communication Visuelle !

Depuis l'acquisition de XL Graphics en octobre 2011 et grâce aux connaissances acquises dans le domaine matériel et logiciel, Papyrus a fortement renforcé sa position sur le marché du grand format. Après une intégration réussie de **XL Graphics** avec le département LFP, Sign and Screen de Papyrus Belgium, l'étape suivante a été une conséquence logique. Les forces de Papyrus et XL Graphics ont été regroupées dans un concept puissant avec le nouveau nom: Papyrus Viscom.

En fusionnant les deux sociétés, chacune avec ses connaissances et ses expériences spécifiques, Papyrus Viscom est devenu un véritable spécialiste dans le domaine des solutions globales pour l'industrie du grand format Print & Sign.

Papyrus Viscom propose un assortiment large et varié de:

**Imprimantes grand format - Traceurs de découpe et tables de coupe - Logiciel - Equipement de finition - Médias d'impression - Vinyles de découpes et accessoires - Formation - Propre service après-vente**

Chez Papyrus Viscom, les clients bénéficient d'une ressource unique et pratique pour une large gamme de produits.

Avec les imprimantes Mutoh et Canon complétées par les traceurs de découpe et tables de découpe Summa, Papyrus Viscom a une solution pour chaque application impression et/ou découpe.

Nous offrons une large gamme de médias avec des marques fortes comme Avery, Hexis, Dickson, RTape, Yupo, Kodak, Chromaluxe et la marque maison Opti.

Nous proposons également une large gamme de périphériques, y compris les tables d'application Roll-X, les tables de découpe Neolt et les lamineurs Kala en combinaison avec une connaissance approfondie des RIP professionnels tels que SAi, Onyx, Caldera. Cela fait de Papyrus Viscom un fournisseur global pour le marché de l'impression grand format et de la découpe numérique.

Dans ce tarif vous allez pouvoir découvrir nos produits. Vous trouverez une table de matières très pratique avec un résumé de notre gamme. Ce tarif contient certaines explications mais si vous avez besoin d'un conseil nous en parlerons de vive voix.

Notre équipe est là pour vous aider.

Nous espérons que ce tarif en complément de notre site et notre conseil personnalisé est une pas dans la bonne direction pour vous informer.

Nous vous remercions de votre confiance et vous souhaitons beaucoup de succès dans vos affaires.

Cordialement,

L'équipe Papyrus Viscom

## Algemene voorwaarden Papyrus

Op al onze verkopen zijn onze algemene verkoopsvoorwaarden van toepassing, eventueel aangevuld met specifieke voorwaarden onderschreven op documenten ter bevestiging van een voorstel, overeenkomst of transactie.

U kan deze algemene verkoopsvoorwaarden online consulteren op [www.papyrus.com](http://www.papyrus.com) of u kan deze bekomen op eenvoudig verzoek

## Specifieke voorwaarden Papyrus Viscom

### Openingsuren

Papyrus Viscom is geopend van maandag t/m vrijdag van 8u30 tot 17u00

### Bestellingen

Bestellen kan per telefoon, e-mail of via de webshop.

Bestellingen van goederen uit voorraad worden binnen 24 uur\* geleverd.

\* In 98% van de zendingen wordt de levering binnen 24u aangeboden. Voor een 100% gegarandeerd tijdslot de volgende werkdag kan een bijkomende transportkost aangerekend worden.

De order entry voor levering volgende werkdag wordt afgesloten volgens onderstaand schema:

- Maandag t/m Donderdag: Standaard orders/volle rollen tot 18h00 - Snijopdrachten tot 17h00
- Vrijdag: Standaard orders/volle rollen tot 17h00 - Snijopdrachten tot 16h00

Afhalen van uw bestellingen in Lembeek is mogelijk, op eenvoudig verzoek en vanaf 1 uur na uw bestelling, tot 20h30 (vrijdag tot 18u30).

Afhalen van uw bestellingen in Mechelen is mogelijk, op eenvoudig verzoek en vanaf volgende werkdag tussen 13h00 & 17h00.

Bestellingen per telefoon: 015/40.50.40 Bestellingen via e-mail: [viscom.be@papyrus.com](mailto:viscom.be@papyrus.com) Bestellingen via webshop: [www.papyrus-viscom.com/be/media/](http://www.papyrus-viscom.com/be/media/)

### Transportkosten

Vanaf een ordergrootte van € 200,00 (exclusief BTW), wordt uw bestelling franco aan huis afgeleverd.

Voor bestellingen onder de € 200,00 wordt een small-order fee van € 25,00 aangerekend.

Voor expres-zendingen berekenen wij de eventuele meerkosten ten opzichte van de normale zendingen. Per levering wordt een brandstof toeslag van 3,68 EUR aangerekend en is een kilometerheffing van toepassing van 2,04 EUR/T met een min. van 5,09 EUR

Voor een retour van goederen op vraag van de klant kan een retour kost van € 50,00 aangerekend worden.

## Conditions générales de Papyrus

Les conditions générales sont applicables sur toutes nos ventes, éventuellement complétées par des conditions spécifiques souscrites sur des documents confirmant d'une proposition, d'un accord ou d'une transaction.

Veillez consulter nos conditions de vente sur notre site [www.papyrus.com](http://www.papyrus.com) ou vous pouvez les obtenir sur simple demande.

## Conditions spécifiques Papyrus Viscom

### Les heures d'ouverture

Papyrus Viscom est ouvert du lundi jusqu'à vendredi de 8h30 à 17h00

### Commandes

Vous pouvez commander par téléphone, par e-mail ou par le webshop.

Les commandes de marchandises en stock peuvent être livrées en 24h\*.

\* Dans 98% des cas les livraisons sont effectuées dans les 24 heures.

Pour garantir à 100% la livraison le jour ouvrable suivant, des frais de transport peuvent être retenus.

Les commandes pour livraison le jour ouvrable suivant sont soumises au schéma suivant:

- Du lundi au jeudi: Commande standard/de rouleaux complets jusqu'à 18h00 - Commande de découpe jusqu'à 17h00
- Vendredi: Commande standard/des rouleaux complets jusqu'à 17h00 - Commande de découpe jusqu'à 16h00

L'enlèvement de vos commandes à Lembeek est possible, sur simple demande et 1 heure après votre commande, jusqu'à 20h30 (vendredi jusqu'à 18u30).

L'enlèvement de vos commandes à Malines est possible sur simple demande et à partir du prochain jour ouvrable de votre commande entre 13h00 et 17h00.

Commande par téléphone: 015/40.50.40 Commande par e-mail: [viscom.be@papyrus.com](mailto:viscom.be@papyrus.com) Commande par le webshop: [www.papyrus-viscom.com/be/fr/media/](http://www.papyrus-viscom.com/be/fr/media/)





















### Frais de transport



A partir d'une commande de €200 (hors TVA), vos commandes sont livrées franco domicile.

Pour les commandes sous €200,00, un coût de traitement pour petite commande de € 25,00 est facturé.

Pour livraison en express, nous facturons les frais supplémentaires par rapport à une livraison normale. Un supplément de carburant de 3,68 EUR est perçu par livraison et un charge kilomètre de 2,04 EUR / T avec un minimum de 5,09 EUR.

Pour un retour de marchandises occasionné par le client, des frais de retour de € 50,00 sont facturés.

Sign Media	 <b>AVERY DENNISON</b>	07 - 38
	 <b>HEXIS</b>	39 - 58
	 <b>rtape</b>	59 - 64
	 <b>3M</b>	65 - 68
	 <b>STAHL'S</b>	69 - 78
Print Media: Solvent - UV - Latex	 <b>AVERY DENNISON</b>	79 - 92
	 <b>HEXIS</b>	93 - 106
	<b>Opti</b> <sup>®</sup>	107 - 122
Print Media: Waterbased	<b>Opti</b> <sup>®</sup>  <b>Kodak</b>  <b>Hahnemühle</b> <small>FINEART</small>	123 - 138
Protection Film	 <b>AVERY DENNISON</b>  <b>HEXIS</b>  <b>STICKYBITS</b> <small>PROTECTING YOUR IMAGE</small>  <b>STEK</b>   <b>AUTOMOTIVE</b> <small>Shield Technology</small>  <b>SCORPION</b> <small>WINDOW FILM</small>	139 - 156
Rigid Media	 <b>ChromaLuxe</b> <sup>®</sup>  <b>unisub</b> <small>From Bare to Brilliant™</small> <b>Opti</b> <sup>®</sup>	157 - 182
Tools & Display	 <b>AVERY DENNISON</b>  <b>HEXIS</b> <b>Opti</b> <sup>®</sup>	183 - 216
	 <b>EASYSREEN</b>	217 - 228
Screen Media	 <b>AVERY DENNISON</b>  <b>mactac</b>	229 - 242

<p>Hardware</p>		<p>243 - 298</p>
<p>Viscom Supplies</p>		<p>297 - 310</p>

# Papyrus Viscom

Prijzlijst / Liste de prix  
Sign Media Avery



**PAPYRUS**   
Your partner in Visual Communication





# Sign Media Avery

<b>AVERY SUPREME WRAPPING FILM</b>	
SWF Glossy Range - Gamme SWF Brillante . . . . .	11
AVERY SUPREME WRAPPING FILM (Vervolg - Suite) . . . . .	12
SWF Glossy Range - Gamme SWF Brillante . . . . .	12
SWF Pearlescent Range - Gamme SWF Nacrée . . . . .	12
SWF Satin Range - Gamme SWF Satinée . . . . .	12
SWF Matte Range - Gamme SWF Mate . . . . .	12
SWF Gloss Metallic Range - Gamme SWF Métallique Brillante . . . . .	12
AVERY SUPREME WRAPPING FILM (Vervolg - Suite) . . . . .	13
SWF High Opacity - Gamme SWF Opaque . . . . .	13
SWF Matte Metallic Range - Gamme SWF Métallique Mate . . . . .	13
SWF Satin Metallic Range - Gamme SWF Métallique Satin . . . . .	13
AVERY SUPREME WRAPPING FILM (Vervolg - Suite) . . . . .	14
SWF Diamond Line - Gamme SWF Diamant . . . . .	14
SWF Brushed Metallic Range - Gamme SWF Métallique Brossée . . . . .	14
SWF ColorFlow - Gamme SWF ColorFlow . . . . .	14
SWF Carbon Range - Gamme SWF Carbone . . . . .	14
SWF Chrome Range - Gamme SWF Chromée . . . . .	14
<b>SUPREME PROTECTION FILM</b>	
SUPREME PROTECTION FILM - FILM DE PROTECTION SUPREME . . . . .	15
<b>AVERY FACADE FILM - Cast</b>	
Ral Range - Gamme Ral . . . . .	15
<b>AVERY 900 SUPERCAST FILM</b>	
Standard Range - Gamme Standard . . . . .	16
AVERY 900 SUPERCAST FILM (Vervolg - Suite) . . . . .	17
AVERY 900 SUPERCAST FILM (Vervolg - Suite) . . . . .	18
PANTONE COLOURS - Couleurs Pantones . . . . .	18
<b>AVERY 800 PREMIUM CAST FILM</b>	
Standard Range - Gamme Standard . . . . .	19
AVERY 800 PREMIUM CAST FILM (Vervolg - Suite) . . . . .	20
<b>AVERY 777 CAST FILM</b>	
Standard Range - Gamme Standard . . . . .	21
AVERY 777 CAST FILM (Vervolg - Suite) . . . . .	22
AVERY 777 CAST FILM (Vervolg - Suite) . . . . .	23
<b>AVERY 700 PREMIUM POLYMERIC FILM</b>	
Standard Range - Gamme Standard . . . . .	24
AVERY 700 PREMIUM POLYMERIC FILM (Vervolg - Suite) . . . . .	25
AVERY 700 PREMIUM POLYMERIC FILM (Vervolg - Suite) . . . . .	26
<b>AVERY 500 EF MONOMERIC EVENT FILM</b>	
Glossy Range - Gamme Brillante . . . . .	27
AVERY 500 EF MONOMERIC EVENT FILM (Vervolg - Suite) . . . . .	28
AVERY 500 EF MONOMERIC EVENT FILM (Vervolg - Suite) . . . . .	29
AVERY 500 EF MONOMERIC EVENT FILM (Vervolg - Suite) . . . . .	30
<b>WINDOW FILMS</b>	
Cast Range - Gamme Coulée . . . . .	31
Polymeric Range - Gamme Polymère . . . . .	31
Polyester Range - Gamme Polyester . . . . .	31
Avery SignFlex™ . . . . .	31
<b>CAST TRANSLUCENT FILMS</b>	
AVERY 5500 QM TRANSLUCENT FILMS - AVERY 5500 QM - FILMS TRANSLUCIDES . . . . .	32
AVERY 5600 LED TRANSLUCENT FILMS - AVERY 5600 LD - FILMS TRANSLUCIDES . . . . .	34
<b>POLYMERIC TRANSLUCENT FILMS</b>	
AVERY 4500 TRANSLUCENT FILMS - AVERY 4500 - FILMS TRANSLUCIDES . . . . .	35
<b>SPECIALTY FILMS</b>	
AVERY 500 FLUOR FILMS - AVERY 500 - FILMS FLUOS . . . . .	36
AVERY 900 FLUOR FILMS - AVERY 900 FILMS FLUOS . . . . .	36
AVERY 1200 BANNER FILMS - AVERY 1200 - FILMS POUR BÂCHES . . . . .	36
AVERY SIGNMASK FILMS - FILMS DE MASQUAGE AVERY . . . . .	36
AVERY FUNCTIONAL FILMS - Avery 7500 - FILMS DE PROTECTION . . . . .	36

## REFLECTIVE FILMS

AVERY HV 1200 / HV 1200E Reflective Film - AVERY HV 1200 / HV 1200E Films Réfléchissants . . . . .	37
Avery V-4000 Retro-Reflective Films - EA - V-4000 Films Retro-Réfléchissants Avery - EA . . . . .	37
Avery V-4000 Retro-Reflective Films - Perm - V-4000 Films Retro-Réfléchissants Avery - Perm. . . . .	37
Avery VisiFlex V 8000 Reflective Film - Avery VisiFlex V 8000 / HV 1200E Films Réfléchissants . . . . .	38



## STRIPING and CONTOURMARKING

AVERY V-6700-B CONSPICUITY TAPE - AVERY V6700-B . . . . .	38
AVERY V-6790 CONSPICUITY TAPE - AVERY V6790 - Film haute visibilité pour la signalisation de contours de véhicules . . . . .	38







## AVERY SUPREME WRAPPING FILM

Gegoten tweelagige film met EARS-luchtkanaaltjestechnologie (Easy Apply Removable Slidable).  
Film coulé double couche avec technologie canaux d'air EARS (Easy Apply Removable Slidable).

Avery Supreme Wrapping Film				
kleuren/couleurs		 m.	 €/m <sup>2</sup>	€/m.
Glossy White and Black	12	1,52	21,61	32,85
Glossy Colours	10			
Pearlescent	5			
Satin	10			
Matte	10			
Gloss Metallic	5			
Matte Metallic	5			
Brushed metallic	4			
Carbon	4			
chrome * 22.8 lm rolls	4	1,22	111,25	135,72

\*chrome: only 2D applications - \*chrome: Uniquement applications 2D.

Duurzaamheid in verticale opstelling. EARS= lijm met luchtkanaaltjes, removable en slidable,  
Durabilité avec mise en place verticale, EARS= Colle avec canaux d'air, enlevable et adaptable.

Color Name			Box Label	Ref. Papyrus	Info	Min. Order m.	€/m. 
<b>SWF Glossy Range - Gamme SWF Brillante</b>							
Dikte - Epaisseur: 80 µ							
SWF White	1,52	25	AV2100001	88142841	-	1	32,85
SWF Red	1,52	25	BP1100001	88272373	-	1	32,85
SWF Cardinal Red	1,52	25	BP1140001	88272371	-	1	32,85
SWF Soft Red	1,52	25	BP1120001	88272372	-	1	32,85
SWF Carmine Red	1,52	25	BP1150001	88272370	-	1	32,85
SWF Burgundy	1,52	25	AV2080001	88142844	-	1	32,85
SWF Light Blue	1,52	25	CB1510001	88105186	-	1	32,85
SWF Intense Blue	1,52	25	CB1690001	88105205	-	1	32,85
SWF Blue	1,52	25	CB1520001	88105187	-	1	32,85
SWF Dark Blue	1,52	25	CB1530001	88105188	-	1	32,85
SWF Indigo Blue	1,52	25	CB1680001	88105204	-	1	32,85
SWF Lime Green	1,52	25	BP1170001	88272366	-	1	32,85
SWF Grass Green	1,52	25	BP1180001	88272368	-	1	32,85
SWF Emerald Green	1,52	25	AS8980001	88134310	-	1	32,85
SWF Dark Green	1,52	25	CB1500001	88105185	-	1	32,85
SWF Grey	1,52	25	CB1550001	88105190	-	1	32,85
SWF Dark Grey	1,52	25	CB1560001	88105191	-	1	32,85
SWF Black	1,52	25	CB1420001	88105177	-	1	32,85
SWF Light Grey	1,52	25	CB1540001	88105189	-	1	32,85
SWF Gloss Cloudy Blue	1,52	25	BK9530001	88239383	-	1	32,85
SWF Gloss Light Pistachio	1,52	25	BK9540001	88239384		1	32,85
SWF Gloss Smoky Blue	1,52	25	BK9560001	88239388	-	1	32,85
SWF Gloss Sea-Breeze Blue	1,52	25	BK9550001	88239389	-	1	32,85
SWF Gloss Radioactive Met	1,52	25	BP1220001	88272365	-	1	32,85
SWF Gloss Magnetic Burst	1,52	25	BL8230001	88262842	-	1	32,85



## AVERY SUPREME WRAPPING FILM (Vervolg - Suite)

Color Name			Box Label	Ref. Papyrus	Info	Min. Order m.	€/m.
------------	--	--	-----------	--------------	------	---------------	------

### SWF Glossy Range - Gamme SWF Brillante

Dikte - Epaisseur: 80 µ

SWF Gloss Spark Met	1,52	25	BP1130001	88272374	-	1	32,85
SWF Gloss Eclipse	1,52	25	BL8220001	88262847	-	1	32,85
SWF Gloss Sand Sparkle	1,52	25	BO8160001	88276824	-	1	32,85
SWF Gloss Rock Grey	1,52	25	BP1080001	88276828	-	1	32,85

### SWF Pearlescent Range - Gamme SWF Nacrée

Dikte - Epaisseur: 80 µ

SWF White Pearl	1,52	25	CB1610002	88105196	-	1	32,85
SWF Gold Orange Pearlescent	1,52	25	AS5130001	88134305		1	32,85
SWF Red Pearlescent	1,52	25	AS8940001	88134307		1	32,85
SWF Light Green Pearlescent	1,52	25	AS8950001	88134308	-	1	32,85
SWF Dark Green Pearlescent	1,52	25	AS8960001	88134309	-	1	32,85
SWF GlossPearl White Snow Pearlescent	1,52	25	BO8450001	88276832	-	1	32,85

### SWF Satin Range - Gamme SWF Satinée

Dikte - Epaisseur: 80 µ

SWF Satin White	1,52	25	AW1690001	88147476	-	1	32,85
SWF Satin Pearl White	1,52	25	AW1700001	88156647	-	1	32,85
SWF Satin Bubblegum Pink	1,52	25	BP1190001	88272367	-	1	32,85
SWF Satin Carmine Red	1,52	25	BP1160001	88272369	-	1	32,85
SWF Satin Khaki Green	1,52	25	AW6720001	88147484	-	1	32,85
SWF Satin Black	1,52	25	AW1680001	88147486	-	1	32,85
SWF Satin Safari Gold	1,52	25	BO8440001	88276833	-	1	32,85
SWF Satin Dark Basalt	1,52	25	BP1090001	88147486	-	1	32,85

### SWF Matte Range - Gamme SWF Mate

Dikte - Epaisseur: 80 µ

SWF Matte White	1,52	25	AV2090001	88142842	-	1	32,85
SWF Matte Orange	1,52	25	AP2240001	88125567	-	1	32,85
SWF Matte Khaki Green	1,52	25	AW7280001	88147474	-	1	32,85
SWF Matte Dark Grey	1,52	25	CB1720001	88105207	-	1	32,85
SWF Matte Black	1,52	25	AS1430001	88105206	-	1	32,85
SWF Matte Beige	1,52	25	AP2300001	88125566		1	32,85
SWF Matte Blue	1,52	25	BJ8020001	88232122	-	1	32,85
SWF Matte Olive Green	1,52	25	BP1070001	88276830	-	1	32,85

### SWF Gloss Metallic Range - Gamme SWF Métallique Brillante

Dikte - Epaisseur: 80 µ

SWF Silver Metallic	1,52	25	CB1570001	88105192	-	1	32,85
SWF Quick Silver Gloss Metallic	1,52	25	AV2560002	88147489	-	1	32,85
SWF Bright Blue Metallic	1,52	25	CB1620001	88105199	-	1	32,85
SWF Dark Blue Metallic	1,52	25	CB1660001	88105200	-	1	32,85
SWF Gold Metallic	1,52	25	CB1580001	88105193	-	1	32,85
SWF Brown Metallic	1,52	25	CB1630001	88105197	-	1	32,85
SWF Grey Metallic	1,52	25	CB1590001	88105194	-	1	32,85
SWF Black Metallic	1,52	25	CB1600001	88105195	-	1	32,85
SWF Metallic Blaze Orange	1,52	25	BB4980001	88168630		1	32,85
SWF Gloss Metallic Acid Green	1,52	25	BJ1090001	88226701	-	1	32,85
SWF Gloss Metallic Passion Red	1,52	25	BR4220001	88292656		1	32,85
SWF Gloss Metallic Fun Purple	1,52	25	BR4180001	88292659		1	32,85



## AVERY SUPREME WRAPPING FILM (Vervolg - Suite)

Color Name			Box Label	Ref. Papyrus	Info	Min. Order m.	€/m.
------------	--	--	-----------	--------------	------	---------------	------

### SWF High Opacity - Gamme SWF Opaque

Dikte - Epaisseur: 119 µ

SWF Gloss Dark Yellow	1,52	25	AV2140001	88251580		1	32,85
SWF Gloss Orange	1,52	25	CB1450001	88251581		1	32,85
SWF Gloss Metallic Quick Silver	1,52	25	AV2560002	88147489		1	32,85
SWF Gloss Ambulance Yellow	1,52	25	AP2310001	88265493		1	32,85
SWF Gloss Yellow	1,52	25	CB1430001	88251585		1	32,85

### SWF Matte Metallic Range - Gamme SWF Métallique Mate

Dikte - Epaisseur: 80 µ

SWF Silver Matte Metallic	1,52	25	AP2270001	88125570	-	1	32,85
SWF Anthracite Matte Metallic	1,52	25	AP2280001	88125571	-	1	32,85
SWF Gunmetal Matte Metallic	1,52	25	AS9120001	88134324	-	1	32,85
SWF Charcoal Matte Metallic	1,52	25	AS9130001	88134326	-	1	32,85
SWF Pink Matte Metallic	1,52	25	AP2230001	88125574	-	1	32,85
SWF Cherry Matte Metallic	1,52	25	AP2220001	88125573	-	1	32,85
SWF Garnet Red Matte Metallic	1,52	25	AS9020001	88134315	-	1	32,85
SWF Blaze Orange Matte Metallic	1,52	25	AV3010001	88147490	-	1	32,85
SWF Brown Matte Metallic	1,52	25	AS9000001	88134313	-	1	32,85
SWF Green Matte Metallic	1,52	25	AP2260001	88125569	-	1	32,85
SWF Apple Green Matte Metallic	1,52	25	AS8970001	88134317	-	1	32,85
SWF Emerald Matte Metallic	1,52	25	AS9010001	88134318	-	1	32,85
SWF Frosty Blue Matte Metallic	1,52	25	AS9070001	88134320	-	1	32,85
SWF Blue Matte Metallic	1,52	25	AS9080001	88134321	-	1	32,85
SWF Brilliant Blue Matte Metallic	1,52	25	AS9090001	88134322	-	1	32,85
SWF Purple Matte Metallic	1,52	25	AS4220001	88134312	-	1	32,85
SWF Night Blue Matte Metallic	1,52	25	AS9100001	88134323	-	1	32,85
SWF Copper Matte Metallic	1,52	25	AP2250001	88125568		25	32,85
SWF Grey Matte Metallic	1,52	25	AP2290001	88125572	-	1	32,85

### SWF Satin Metallic Range - Gamme SWF Métallique Satin

Dikte - Epaisseur: 80 µ

SWF Satin Metallic Dove Grey	1,52	25	BJ0820001	88226688	-	1	32,85
SWF Satin Metallic Dark Blue	1,52	25	BJ0850001	88226691	-	1	32,85
SWF Satin Metallic Light Brown	1,52	25	BJ0860001	88226692	-	1	32,85
SWF Satin Metallic Hans Brown	1,52	25	BJ0880001	88226693	-	1	32,85
SWF Satin Metallic Grey Blue	1,52	25	BJ0940001	88226695	-	1	32,85
SWF Satin Metallic Light Grey	1,52	25	BJ0890001	88226698	-	1	32,85
SWF Satin Metallic Graphite	1,52	25	BJ1030001	88226699	-	1	32,85
SWF Satin Metallic Energetic Yellow	1,52	25	BR9670001	88292658	NEW	1	58,62
SWF SatinMetal Wave Blue	1,52	25	BS8330001	88300179	NEW	1	32,85
SWF SatinMetal Hope Green	1,52	25	BS8310001	88300189	NEW	1	40,53
SWF SatinMetal StunningOrange	1,52	25	BS9830001	88300192	NEW	1	40,53
SWF SatinMetal Cool Teal	1,52	25	BT1800001	88300194	NEW	1	32,85
SWF SatinMetal LivelyGreen	1,52	25	BT1790001	88300196	NEW	1	32,85
SWF SatinMetal Blissful Purple	1,52	25	BT1780001	88300197	NEW	1	32,85



## AVERY SUPREME WRAPPING FILM (Vervolg - Suite)

Color Name			Box Label	Ref. Papyrus	Info	Min. Order m.	€/m.
------------	--	--	-----------	--------------	------	---------------	------

### SWF Diamond Line - Gamme SWF Diamant

Dikte - Epaisseur: 80 µ

SWF Diamond White	1,52	25	BD3030001	88168622	-	1	32,85
SWF Diamond Amber	1,52	25	BD2800001	88168623		1	32,85
SWF Diamond Purple	1,52	25	BD3050001	88168624		1	32,85
SWF Diamond Red	1,52	25	BD3040001	88168625	-	1	32,85
SWF Diamond Blue	1,52	25	BD2890001	88168626	-	1	32,85
SWF Diamond Silver	1,52	25	BI9310001	88226683	-	1	32,85

### SWF Brushed Metallic Range - Gamme SWF Métallique Brossée

Dikte - Epaisseur: 80 µ

SWF Brushed Bronze	1,52	25	AR1350001	88125748	-	1	58,62
SWF Brushed Aluminium	1,52	25	AR1300001	88125578	-	1	58,62
SWF Brushed Titanium	1,52	25	AR1230001	88125575	-	1	58,62
SWF Brushed Steel	1,52	25	AR1280001	88125577	-	1	58,62
SWF Brushed Black	1,52	25	AR1310001	88125749	-	1	58,62

### SWF ColorFlow - Gamme SWF ColorFlow

Dikte - Epaisseur: 81 µ

SWF Fresh Spring Gold/Silver Satin	1,52	25	BG7460001	88201669	-	1	58,62
SWF UrbanJungle Silver/Green	1,52	25	BG7590001	88201677	-	1	58,62
SWF RoaringThunder Blue/Red	1,52	25	BG7470001	88201678	-	1	58,62
SWF RushingRiptide Cyan/Purple	1,52	25	BG7600001	88201679	-	1	58,62
SWF Satin Lightning Ridge Purple/Green	1,52	25	BJ1080001	88226653	-	1	58,62
SWF Rising Sun Red/Gold	1,52	25	BG7580001	88201680	-	1	58,62
SWF Gloss Lightning Ridge Purple/Green	1,52	25	BJ1050001	88226652	-	1	58,62
SWF Gloss Fresh Spring Gold/Silver	1,52	25	BJ0810001	88226654	-	1	58,62
SWF Gloss Rising Sun Red/Gold	1,52	25	BJ1010001	88226658	-	1	58,62
SWF Gloss Roaring Thunder Blue/Red	1,52	25	BJ0840001	88226659	-	1	58,62
SWF Gloss Rushing Riptide Cyan/Purple	1,52	25	BJ1100001	88226660	-	1	58,62
SWF Gloss Urban Jungle Silver/Green	1,52	25	BJ0950001	88226682	-	1	58,62

### SWF Carbon Range - Gamme SWF Carbone

Dikte - Epaisseur: 80 µ

SWF Carbon Fibre White	1,52	25	AS1850001	88125750	-	1	58,62
SWF Carbon Fibre Black	1,52	25	AS1880001	88125579	-	1	58,62

### SWF Chrome Range - Gamme SWF Chromée

Dikte - Epaisseur: 142 µ

SWF Conform Chrome Blue	1,22	22,8	AT8430002	88147497	End of Stock	1	139,83
SWF Chrome Silver	1,35	22,8	BM6450001	88263119	-	1	135,72
SWF Chrome Black	1,35	22,8	BM6580001	88263141	-	1	135,72
SWF Chrome Blue	1,35	22,8	BM6570001	88263144	-	1	135,72
SWF Chrome Gold	1,35	22,8	BM6530001	88263145	-	1	135,72
SWF Chrome Red	1,35	22,8	BM6560001	88263146	-	1	135,72
SWF Chrome Matte Silver	1,35	22,8	BM6640001	88263148		1	135,72
SWF Chrome Violet	1,35	22,8	BM6620001	88263152		1	135,72
SWF Chrome Rose Gold	1,35	22,8	BM6590001	88263153	-	1	135,72



## AVERY SUPREME WRAPPING FILM - COLOURMATCH

Color Name			Nbre Rolls	Ref. Papyrus	Info	Min. Order m.	€/m.
Dikte - Epaisseur: 80 µ							
SWF Colourmatch	1,52	25	10 rolls -> 29 rolls	-	-	300	39,42
SWF Colourmatch	1,52	25	>30 rolls	-	-	750	32,85

Minimum aankoop : 450m<sup>2</sup> / 12 rollen - Raadpleeg ons voor een offerte.  
Achat minimal : 450m<sup>2</sup> / 12 rouleaux - Consultez nous pour une offre.

## SUPREME PROTECTION FILM

### SUPREME PROTECTION FILM - FILM DE PROTECTION SUPREME

				Ref. Papyrus	Info	€/roll	€/m <sup>2</sup>
Avery Protection Film- SPF-X -							
165µ	1,52	15		BK9530001	88264712 New -	1332,89	60,8

## AVERY FACADE FILM - Cast

Film voor de renovatie van gebouwen. Geschikt voor gebogen en onregelmatige oppervlakken, voor een gladde afwerking vergelijkbaar met en een alternatief voor het schilderen. Permanente acryl lijm met hoge kleefkracht.

Film pour la rénovation de bâtiments. Recouvre les surfaces courbes et irrégulières, pour une finition lisse semblable à de la peinture, adhésif acrylique, permanent, à haute adhésion.

Color Name			Box Label	Ref. Papyrus	Info	Min. Order m.	€/m.
Ral Range - Gamme Ral							
Dikte - Epaisseur: 50 µ							
FF Ral 3003 Ruby Red Gloss	1,23	50	CD2570012			100	30,5
FF Ral 3005 Wine Red Gloss	1,23	50	DK2610011			100	30,5
FF Ral 3005 Wine Red Lustre	1,23	50	CD1180012			100	30,5
FF Ral 5001 Green Blue Gloss	1,23	50	DK2630013			100	30,5
FF Ral 5003 Saph Blue Gloss	1,23	50	CD9170012			100	30,5
FF Ral 5005 Signl Blue Gloss	1,23	50	DK2620013			100	30,5
FF Ral 5011 Steel Blue Gloss	1,23	50	DK2600013			100	30,5
FF Ral 6007 Botl Green Gloss	1,23	50	CD2300012			100	30,5
FF Ral 6009 Fir Green Gloss	1,23	50	CD9050013			100	30,5
FF Ral 7016 Anthr Grey Gloss	1,23	50	CD9470012			100	30,5
FF Ral 7016 Anthr Grey Lustre	1,23	50	CD1790012			100	30,5
FF Ral 7021 Black Grey Gloss	1,23	50	CD2720012			100	30,5
FF Ral 7022 Umbra Grey Gloss	1,23	50	DK2590001			100	30,5
FF Ral 7022 Umbra Grey Lustre	1,23	50	CD1710002			100	30,5
FF Ral 9001 Cream Gloss	1,23	50	CD9310012			100	30,5
FF Ral 9001 Cream Lustre	1,23	50	CD1820012			100	30,5
FF Ral 9005 Jet Black Gloss	1,23	50	CE1180012			100	30,5
FF Ral 9006 White Alu Gloss	1,23	50	CD2520012			100	30,5
FF Ral 9007 Grey Alu Gloss	1,23	50	CD9160012			100	30,5
FF Ral 9010 Pure White Gloss	1,23	50	CD9480012			100	30,5
FF Ral 9010 Pure White Lustre	1,23	50	CD1800012			100	30,5
FF Ral 9016 Traf White Gloss	1,23	50	DK2580011			100	30,5





## AVERY 900 SUPERCAST FILM

Gegoten film voor 3D-markeringen, voor kort- en langdurig gebruik.  
Film coulé pour les marquages 3D pour un usage de longue ou de courte durée.

AVERY 900 SUPERCAST				
kleuren/couleurs				€/m.
White and Black	12	1,23	16,20	19,93
Glossy Colours	10		17,03	20,95
Metallics	6		20,09	24,71

Color Name			Box Label	Ref. Papyrus	Info	Min. Order m.	€/m.
<b>Standard Range - Gamme Standard</b>							
Dikte - Epaisseur: 50 µ							
900 White Gloss	0,61	50	CD1090003	88105368	-	5	10,78
900 White Gloss	1,23	50	CD1090001	88105076	-	5	19,93
901 Black	0,61	50	CD9570008	88105369	-	5	10,78
901 Black	1,23	50	CD9570001	88105077	-	5	19,93
902-01 Buttercup yellow	1,23	50	AY9760001	88158469	-	1	20,95
903 Tomato Red	1,23	25	CE1490007	88105079	-	1	20,95
904-01 Chrome Yellow	1,23	25	AY6030001	88158470	-	1	20,95
906-01 Medium Red	1,23	50	AY6110001	88158471	-	1	20,95
907 Light Green	1,23	25	CE1520006	88105082	-	1	20,95
908 Kelly Green	1,23	25	CE1530008	88105083	-	1	20,95
909 Sapphire Blue	1,23	50	CE1540002	88105084	-	1	20,95
910-01 Dark Orange	1,23	50	AY6270001	88158472	-	1	20,95
911-01 Light Orange	1,23	25	AY7480002	88158473	-	1	20,95
912 Gentian Blue	1,23	25	CE1570004	88105087	-	1	20,95
913 IvoryPerm	1,23	25	CE1580005	88105088	-	1	20,95
914 CreamPerm	1,23	25	CE1590007	88105089	-	1	20,95
915 Mahogany Brown	1,23	25	CE1600003	88105090	-	1	20,95
916-01 Dark Green	1,23	25	AY7670002	88158474	-	1	20,95
917 Taxi Beige	1,23	25	CE1620003	88105092	-	1	20,95
918 Grey	1,23	25	CE1630007	88105093	-	1	20,95
920 White Matt - Blue Contrast	1,23	25	CD1100004	88105094	-	5	19,93
921 Matt Black	1,23	25	CE2750009	88105095	-	5	19,93
922 Geranium Red	1,23	25	CE1640004	88105096	-	1	20,95
923 Burgundy	1,23	25	CE1650005	88105097	-	1	20,95
924 Dark Red	1,23	25	CE1660005	88105098	-	1	20,95
925-01 Signal Red	1,23	25	AY6330002	88158475	-	1	20,95
926-01 Sunrise	1,23	25	AY7790002	88158476	-	1	20,95
927-01 Sunflower Yellow	1,23	50	AY7890001	88158477	-	1	20,95
928-01 Bright Yellow	1,23	50	AY7980001	88158478	-	1	20,95
929 Green	1,23	25	CE1720006	88105103	-	1	20,95
930 Wine Red	1,23	25	CE1730004	88105104	-	1	20,95
931 Emerald Green	1,23	25	CE1740004	88105105	-	1	20,95
932 Indigo Blue	1,23	25	CE1750007	88105106	-	1	20,95
933 Midnight Blue	1,23	50	CE1760003	88105107	-	1	20,95
934 Vivid Blue	1,23	25	CE1770005	88105108	-	1	20,95
935 Intense Blue	1,23	50	CE1780002	88105109	-	1	20,95
937 Morning Orange	1,23	25	CE1800005	88105110	-	1	20,95
938-01 Sweet Orange	1,23	25	AZ1130001	88158479	-	1	20,95





## AVERY 900 SUPERCAST FILM (Vervolg - Suite)

Color Name			Box Label	Ref. Papyrus	Info	Min. Order m.	€/m.
<b>Standard Range (Vervolg - Suite)</b>							
Dikte - Epaisseur: 50 µ							
939 Royal Blue	1,23	25	CE1820007	88105112	-	1	20,95
940 Transparent	1,23	25	CE2310003	88168592	-	1	20,95
941 Cosmos Blue	1,23	25	CE1840008	88105113	-	1	20,95
942 Light Blue	1,23	50	CE1850002	88105114	-	1	20,95
943 Petrol	1,23	25	CE1860005	88105115	-	1	20,95
944 Aqua	1,23	25	CE1870003	88105116	-	1	20,95
945 Golf Green	1,23	25	CE1880003	88105117	-	1	20,95
946 Caribbean Aqua	1,23	25	CE1890003	88125485	-	1	20,95
947 Magenta	1,23	25	CE1900003	88125685	-	1	20,95
948 Purple	1,23	25	CE1910006	88105118	-	1	20,95
950 Carmine Red	1,23	25	CE1920005	88105119	-	1	20,95
951 Primrose Yellow	1,23	50	CE1930002	88105120	-	1	20,95
954 Lila	1,23	25	CE1950004	88105121	-	1	20,95
955-01 Cardinal Red	1,23	25	AY6590002	88158480	-	1	20,95
956 Grass Green	1,23	25	CE1970005	88105123	-	1	20,95
957 Cobalt Blue	1,23	25	CE1980006	88105124	-	1	20,95
959 Rioja Red	1,23	25	CE1990003	88105125	-	1	20,95
960 Dove Grey	1,23	25	CE2000008	88105126	-	1	20,95
961 Pearl Grey	1,23	50	CE2010005	88105127	-	1	20,95
962 Stormy Grey	1,23	25	CE2020009	88105128	-	1	20,95
963 Airforce Blue	1,23	25	CE2030005	88105129	-	1	20,95
964 Sea Blue	1,23	25	CE2040007	88105130	-	1	20,95
965 Mint	1,23	25	CE2050004	88105131	-	1	20,95
966 Meadow Green	1,23	25	CE2060004	88125687	-	1	20,95
967 Leaf Green	1,23	25	CE2070005	88105132	-	1	20,95
968 Empire Blue	1,23	50	CE2080002	88105133	-	1	20,95
969 Passion Blue	1,23	50	CE2090002	88105134	-	1	20,95
970 Bottle Green	1,23	25	CE2100004	88105135	-	1	20,95
971 Turquoise	1,23	25	CE2110005	88105136	-	1	20,95
972-01 Lemon	1,23	25	AY6410001	88158481	-	1	20,95
973 Mocha	1,23	25	CD9980003	88105138	-	1	20,95
978 Light Purple	1,23	25	CE2160003	88105142	-	1	20,95
979 Swimming Blue	1,23	25	CE2170007	88105143	-	1	20,95
980-01 Spanish Orange	1,23	25	AY9620001	88158482	-	1	20,95
981 Soft Red	1,23	50	CE2190002	88105145	-	1	20,95
982 Antique Blue	1,23	25	CE2200005	88105146	-	1	20,95
983 Gunmetal Grey	1,23	25	CE2210007	88105147	-	1	20,95
984 Dark Purple	1,23	25	CE2220004	88105148	-	1	20,95
985 Springtime Green	1,23	25	CE2230006	88105149	-	1	20,95
986 Pink	1,23	25	CE2240006	88105150	-	1	20,95
987-01 Spicy Red	1,23	50	AY9900001	88158483	-	1	20,95
990 Silver Metallic	1,23	50	CE0040003	88105152	-	1	24,71
991 Gold Metallic	1,23	50	CE2260002	88105153	-	1	24,71
992 Grey Metallic	1,23	50	CE2270002	88105154	-	1	24,71



## AVERY 900 SUPERCAST FILM (Vervolg - Suite)

Color Name			Box Label	Ref. Papyrus	Info	Min. Order m.	€/m.
------------	--	--	-----------	--------------	------	---------------	------

### PANTONE COLOURS - Couleurs Pantones

Dikte - Epaisseur: 50 µ

Pantone 021C	1,23	50	CD3400001	88105168	-	1	20,23
Pantone 137C	1,23	50	CD3560001	88105156	-	1	20,23
Pantone 368C	1,23	50	CD5110001	88105169	-	1	20,23
Pantone 404C	1,23	50	CD2110251	88105170	-	1	20,23

## AVERY 900 SUPERCAST FILM - COLOURMATCH

Color Name			Nbre Rolls	Ref. Papyrus	Info	Min. Order m.	€/m.
------------	--	--	------------	--------------	------	---------------	------

Dikte

- Epaisseur: 50 µ

900 SC Colourmatch	1,23	50	1 roll	1,95	-	50	40,85
900 SC Colourmatch	1,23	50	2 rolls	1,85	-	100	38,76
900 SC Colourmatch	1,23	50	3 rolls	1,5	-	150	31,43
900 SC Colourmatch	1,23	50	4 rolls	1,35	-	200	28,28
900 SC Colourmatch	1,23	50	5-8 rolls	1,25	-	250	26,19
900 SC Colourmatch	1,23	50	9-16 rolls	1,1	-	450	23,05
900 SC Colourmatch	1,23	50	>16 rolls	Prix Tarif normal	-	800	20,95

Levertijd kleurnastellingen: 2 tot 3 weken



## AVERY 800 PREMIUM CAST FILM

Gegoten film voor 2D-toepassingen.  
Film coulé pour les applications 2D.

AVERY 800 PREMIUM CAST FILM				
kleuren/couleurs				€/m.
White and Black	10	1,23	8,38	10,31
Glossy Colours	8		8,93	10,98
Metallics	5		8,93	10,98

Color Name			Box Label	Ref. Papyrus	Info	Min. Order m.	€/m.
------------	--	--	-----------	--------------	------	---------------	------

### Standard Range - Gamme Standard

Dikte - Epaisseur: 50 µ

800 White - Blue Contrast	0,615	50		88105326	-	5	5,62
800 White - Blue Contrast	1,23	50		88105004	-	5	10,31
800-01 Off White	1,23	50		88125731	-	1	9,96
801 Black	0,615	50		88105327	-	5	5,62
801 Black	1,23	50		88105005	-	5	10,31
802 Burgundy Red	1,23	50		88105006	-	1	10,98
803 Cherry Red	1,23	50		88105007	-	1	10,98
806-01 Sunflower Yellow	1,23	50		88152593	-	1	10,55
807 Primrose Yellow	1,23	50		88105010	-	1	10,98
808 Cosmos Blue	1,23	50		88105011	-	1	10,98
809 Ocean Blue	1,23	50		88105012	-	1	10,98
811 Forest Green	1,23	50		88105013	-	1	10,98
812 Cactus Green	1,23	50		88105014	-	1	10,98
813 Grass Green	1,23	50		88105015	-	1	10,98
814 Lime	1,23	50		88105016	-	1	10,98
814-01 Wasabi Green	1,23	50		88125512	-	1	10,98
815 Cyclamen	1,23	50		88105017	-	1	10,98
817 Violet	1,23	50		88105018	-	1	10,98
818 Chocolate Brown	1,23	50		88105019	-	1	10,98
818-01 Safari Brown Matt	1,23	50		88125516	-	1	10,98
819 Beige	1,23	50		88105020	-	1	10,98
820 Grey	1,23	50		88105021	-	1	10,98
821 Black Matt	1,23	50		88105022	-	5	9,39
823 Dark Blue	1,23	50		88105023	-	1	10,98
824 Cobalt Blue	1,23	50		88105024	-	1	10,98
824-01 Deep Blue	1,23	50		88125732	-	1	10,98
825 Medium Grey	1,23	50		88105025	-	1	10,98
826-01 Medium Red	1,23	50		88152594	-	1	10,55
830 White Matt - Blue Contrast	1,23	50		88105027	-	5	10,31
831 Turquoise	1,23	50		88105028	-	1	10,98
832 Light Blue	1,23	50		88105029	-	1	10,98
834 Kelly Green	1,23	50		88105030	-	1	10,98
835 Silver Metallic	1,23	50		88105031	-	1	10,98
835-01 Silver Met,Matt	1,23	50		88125522	-	1	10,98
836 Gold Metallic	1,23	50		88105032	-	1	10,98
837-01 Bright Red	1,23	50		88152595	-	1	10,98
839 Bright Yellow	1,23	50		88105034	-	1	10,98
840 Transparent	1,23	50		88105035	-	1	10,31
841 Scuba Blue	1,23	50		88105036	-	1	10,98
842 Teal	1,23	50		88105037	-	1	10,98



## AVERY 800 PREMIUM CAST FILM (Vervolg - Suite)

Color Name			Box Label	Ref. Papyrus	Info	Min. Order m.	€/m.
------------	--	--	-----------	--------------	------	---------------	------

### Standard Range (Vervolg - Suite)

Dikte - Epaisseur: 50 µ

844 Dove Grey	1,23	50		88105038	-	1	10,98
845 Mist	1,23	50		88105039	-	1	10,98
846 Grey Metallic	1,23	50		88105040	-	1	10,98
847 Marine Blue	1,23	50		88105041	-	1	10,98
848-02 Bright Orange	1,23	50		88152596	-	1	10,98
849 Geranium Red	1,23	50		88105043	-	1	10,98
850 Tomato Red	1,23	50		88105044	-	1	10,98
851 Vivid Blue	1,23	50		88105045	-	1	10,98
852 Sapphire Blue	1,23	50		88105046	-	1	10,98
853 Royal Blue	1,23	50		88105047	-	1	10,98
854 Green	1,23	50		88105048	-	1	10,98
855-01 Yellow	1,23	50		88152597	-	1	10,98
856-01 Dark Yellow	1,23	50		88152598	-	1	10,98
857 Ivory	1,23	50		88105051	-	1	10,98
858 Dark Red	1,23	50		88105052	-	1	10,98
859 Light Grey	1,23	50		88105053	-	1	10,98
860-01 Corn Yellow	1,23	50		88152599	-	1	10,55
861 Cream	1,23	50		88105055	-	1	10,98
862-01 Signal Yellow	1,23	50		88152600	-	1	10,55
863 Dark Burgundy	1,23	50		88105057	-	1	10,98
864 Red	1,23	50		88105058	-	1	10,98
866-01 Light Orange	1,23	50		88152601	-	1	10,98
867 Deep Purple	1,23	50		88105061	-	1	10,98
868 Purple	1,23	50		88125494	-	1	10,98
869 Intense Blue	1,23	50		88105062	-	1	10,98
873 Magenta	1,23	50		88105063	-	1	10,98
874 Brilliant Blue	1,23	50		88105064	-	1	10,98
875 Standard Blue	1,23	50		88105065	-	1	10,98
876 Navy Blue	1,23	50		88105066	-	1	10,98
877 Bright Blue	1,23	50		88105067	-	1	10,98
878 Leaf Green	1,23	50		88105068	-	1	10,98
879 Bright Green	1,23	50		88105069	-	1	10,98
880-01 Brown	1,23	50		88152602	-	1	10,55
881 Dark Grey	1,23	50		88105071	-	1	10,98
881-01 Dark Grey Matt	1,23	50		88125517	-	1	10,98
883 Hazelnut Brown	1,23	50		88125501	-	1	10,98
885 Cloud Grey	1,23	50		88105074	-	1	10,98
886 Cool Grey	1,23	50		88105075	-	1	10,98
886-01 Mouse Grey	1,23	50		88125518	-	1	10,98
891 Silver Grey Metallic	1,23	50		88125503	-	1	10,98
892 Light Grey Metallic	1,23	50		88125505	-	1	10,98
893 Charcoal Metallic	1,23	50		88125508	-	1	10,98
894 Dark Grey Metallic	1,23	50		88125509	-	1	10,98
895 Dark Argent Metallic	1,23	50		88125510	-	1	10,98
896 Black Metallic	1,23	50		88125511	-	1	10,98
897 Bronze Metallic	1,23	50		88125723	-	1	10,98
898 Bright Gold Metallic	1,23	50		88125729	-	1	10,98

### AVERY 800 PREMIUM CAST FILM - COLOURMATCH

800 PC Colourmatch	1,23	50	5-8 rolls	1,5	-	250	16,46
800 PC Colourmatch	1,23	50	9-16 rolls	1,35	-	450	14,82
800 PC Colourmatch	1,23	50	>16 rolls	1,25	-	800	13,72



## AVERY 777 CAST FILM

AVERY 777 CAST FILM				
kleuren/couleurs				€/m.
White and Black	8	1,23	7,26	8,93
Glossy Colours	7		7,59	9,70
Metallics	5		7,89	9,70

Color Name			Box Label	Ref. Papyrus	Info	Min. Order m.	€/m.
------------	--	--	-----------	--------------	------	---------------	------

### Standard Range - Gamme Standard

Dikte - Epaisseur: 60 µ

777-000 White	1,23	50	BB2030001	88156496	-	5	8,93
777-001 Black	1,23	50	BB2010001	88156497	-	5	8,93
777-002 Sweet Red	1,23	50	BB2150001	88156383	-	1	9,70
777-003 Cherry Red	1,23	50	BB2180001	88156384	-	1	9,70
777-004 Sun Yellow	1,23	50	BB2620001	88156385		1	9,70
777-005 Orange	1,23	50	BB2120001	88156386	-	1	9,70
777-006 Sunflower	1,23	50	BB2070001	88156387		1	9,70
777-007 Cardinal Red	1,23	50	BB2160001	88156388	-	1	9,70
777-008 Cosmos Blue	1,23	50	BB2290001	88156389	-	1	9,70
777-009 Ocean Blue	1,23	50	BB2250001	88156390	-	1	9,70
777-010 Gold Yellow	1,23	50	BB2090001	88156391	-	1	9,70
777-011 Euro Blue	1,23	50	BB2240001	88156392	-	1	9,70
777-012 Cactus Green	1,23	50	BB2420001	88156393	-	1	9,70
777-013 Geranium Red	1,23	50	BB2170001	88156395	-	1	9,70
777-014 Lime	1,23	50	BB2400001	88156396	-	1	9,70
777-015 Cyclamen Red	1,23	50	BB2210001	88156397	-	1	9,70
777-016 Pink	1,23	50	BB2640001	88156398	-	1	9,70
777-017 Light Grey	1,23	50	BB2450001	88156399	-	1	9,70
777-018 Middle Grey	1,23	50	BB2470001	88156400	-	1	9,70
777-019 Beige	1,23	50	BB2650001	88156402		1	9,70
777-020 Grey	1,23	50	BB2510001	88156403	-	1	9,70
777-021 Black Matt	1,23	50	BB2020001	88156498	-	5	8,93
777-022 Pastel Orange	1,23	50	BB2110001	88156404		1	9,70
777-023 Dark Blue	1,23	50	BB2350001	88156405	-	1	9,70
777-024 Cobalt Blue	1,23	50	BB2370001	88156406	-	1	9,70
777-025 Cloud Grey	1,23	50	BB2500001	88156407		1	9,70
777-026 Medium Red	1,23	50	BB2140001	88156408	-	1	9,70
777-027 Passion Blue	1,23	50	BB2360001	88156409		1	9,70
777-028 Caramel	1,23	50	BB2690001	88156410	-	1	9,70
777-029 Mint	1,23	50	BB2700001	88156412	-	1	9,70
777-030 White Matt	1,23	50	BB2040001	88156499	-	5	8,93
777-031 Turquoise	1,23	50	BB2710001	88156413	-	1	9,70
777-032 Ice Grey	1,23	50	BB2460001	88156414	-	1	9,70
777-033 Blue	1,23	50	BB2310001	88156415	-	1	9,70
777-034 Yellow Green	1,23	50	BB2410001	88156416	-	1	9,70
777-035 Silver Metallic	1,23	50	BB2600001	88156488	-	1	9,70
777-036 Gold Metallic	1,23	50	BB2610001	88156489	-	1	9,70
777-037 Alfa Blue	1,23	50	BB2380001	88156417	-	1	9,70
777-038 Trafic Blue	1,23	50	BB2280001	88156418	-	1	9,70
777-039 Bright Yellow	1,23	50	BB2060001	88156419	-	1	9,70
777-040 Transparant	1,23	50	BB2050001	88156500	-	1	8,93
777-041 Scuba Blue	1,23	50	BB2270001	88156420		1	9,70



## AVERY 777 CAST FILM (Vervolg - Suite)

Color Name			Box Label	Ref. Papyrus	Info	Min. Order m.	€/m.
<b>Standard Range (Vervolg - Suite)</b>							
Dikte - Epaisseur: 60 µ							
777-042 Teal	1,23	50	BB2730001	88156425		1	9,70
777-043 King Blue	1,23	50	BB2330001	88156426	-	1	9,70
777-044 Dove Grey	1,23	50	BB2490001	88156427	-	1	9,70
777-045 Telegrey	1,23	50	BB2480001	88156428	-	1	9,70
777-046 Grey Metallic	1,23	50	BB2560001	88156491	-	1	9,70
777-047 Marine blue	1,23	50	BB2340001	88156429	-	1	9,70
777-048 Bright Orange	1,23	50	BB2130001	88156432	-	1	9,70
777-049 Fawn Brown	1,23	50	BB2630001	88156433		1	9,70
777-050 Tomato Bred	1,23	50	BB2760001	88156434	-	1	9,70
777-051 Azure Blue	1,23	50	BB2260001	88156435	-	1	9,70
777-052 UltramarinBlue	1,23	50	BB2300001	88156436	-	1	9,70
777-053 Royal Blue	1,23	50	BB2320001	88156437	-	1	9,70
777-054 Deep Green	1,23	50	BB2430001	88156438		1	9,70
777-055 Yellow	1,23	50	BB2080001	88156439	-	1	9,70
777-056 Green	1,23	50	BB2790001	88156440		1	9,70
777-057 Ivory	1,23	50	BB2810001	88156441	-	1	9,70
777-058 Dark Red	1,23	50	BB2200001	88156442	-	1	9,70
777-059 Dark Grey	1,23	50	BB2540001	88156443	-	1	9,70
777-060 Orange	1,23	50	BB2830001	88156445		1	9,70
777-061 Cream	1,23	50	BB2660001	88156446		1	9,70
777-062 Dark Brown	1,23	50	BB2840001	88156447		1	9,70
777-063 Regal Red	1,23	50	BB2850001	88156448	-	1	9,70
777-064 Red	1,23	50	BB2190001	88156449		1	9,70
777-065 Stone Grey	1,23	50	BB2670001	88156450	-	1	9,70
777-066 Light Orange	1,23	50	BB2100001	88156452	-	1	9,70
777-067 Purple Red	1,23	50	BB2930001	88156453	-	1	9,70
777-068 Steel Blue	1,23	50	BB2680001	88156454		1	9,70
777-069 Dodger Blue	1,23	50	BB2720001	88156456	-	1	9,70
777-070 Deep Grey	1,23	50	BB2530001	88156457	-	1	9,70
777-071 Lipstick Red	1,23	50	BB2860001	88156458	-	1	9,70
777-072 Fuchsia	1,23	50	BB2870001	88156459	-	1	9,70
777-073 Telemagenta	1,23	50	BB2880001	88156460		1	9,70
777-074 Magenta	1,23	50	BB2890001	88156461	-	1	9,70
777-075 Lavender	1,23	50	BB2900001	88156462		1	9,70
777-076 Lilac	1,23	50	BB2220001	88156463		1	9,70
777-077 Purple	1,23	50	BB2910001	88156464	-	1	9,70
777-078 Nut Brown	1,23	50	BB2740001	88156465		1	9,70
777-079 Bright Green	1,23	50	BB2780001	88156466	-	1	9,70
777-080 Denim Blue	1,23	50	BB2750001	88156467		1	9,70
777-081 Emerald	1,23	50	BB2440001	88156468		1	9,70
777-082 Pastel	1,23	50	BB2230001	88156469		1	9,70
777-083 Light Green	1,23	50	BB2770001	88156470	-	1	9,70
777-084 Light Brown	1,23	50	BB2820001	88156471	-	1	9,70
777-085 Iron Grey	1,23	50	BB2520001	88156472	-	1	9,70
777-086 Dark Teal	1,23	50	BB2940001	88156473		1	9,70
777-087 Bordeaux	1,23	50	BB2920001	88156474	-	1	9,70
777-088 BlackBlue	1,23	50	BB2390001	88156475	-	1	9,70
777-089 Ink Blue	1,23	50	BB2950001	88156480		1	9,70
777-090 Red	1,23	50	BB2960001	88156481		1	9,70
777-091 SilverGreyMet	1,23	50	BB2590001	88156493	-	1	9,70
777-092 Komatsu	1,23	50	BB2550001	88156482	-	1	9,70
777-093 Olive	1,23	50	BB2800001	88156483		1	9,70
777-094 GraphiteMeta	1,23	50	BB2580001	88156494	-	1	9,70



## AVERY 777 CAST FILM (Vervolg - Suite)

Color Name			Box Label	Ref. Papyrus	Info	Min. Order m.	€/m.
<b>Standard Range (Vervolg - Suite)</b>							
Dikte - Epaisseur: 60 µ							
777-095 Anthracite	1,23	50	BB2570001	88156495	-	1	9,70
777-096 Blue Green	1,23	50	BB2980001	88156484	-	1	9,70
777-097 TurquoiseBlue	1,23	50	BB2990001	88156485		1	9,70
777-098 Petrol	1,23	50	BB3000001	88156486		1	9,70
777-099 Deep Blue	1,23	50	BB2970001	88156487	-	1	9,70



## AVERY 700 PREMIUM POLYMERIC FILM

Polymeer gekalanderde film voor vlakke en lichtgebogen ondergronden.  
Film calandré polymère pour des surfaces planes ou légèrement courbées,.

AVERY 700 PREMIUM POLYMERIC FILM				
kleuren/couleurs				€/m.
White and Black	8	1,23	6,82	8,39
Glossy Colours	7		7,42	9,13
Metallics	5		7,42	9,13

Color Name			Box Label	Ref. Papyrus	Info	Min. Order m.	€/m.
<b>Standard Range - Gamme Standard</b>							
Dikte - Epaisseur: 80 µ							
700 PF White	0,615	50		88105252	-	5	4,62
700 PF White	1,23	50		88104907	-	5	8,39
701 PF Black	0,615	50		88105253	-	5	4,62
701 PF Black	1,23	50		88104908	-	5	8,39
702 PF Burgundy Red	1,23	50		88104909	-	1	9,13
703 PF Cherry Red	0,615	50		88105255	-	1	5,02
703 PF Cherry Red	1,23	50		88104910	-	1	9,13
704 PF Signal Yellow	1,23	50		88104911	-	1	9,13
705 PF Orange	0,615	50		88105257	-	1	5,02
705 PF Orange	1,23	50		88104912	-	1	9,13
706 PF Sunflower Yellow	0,615	50		88105258	-	1	5,02
706 PF Sunflower Yellow	1,23	50		88104913	-	1	9,13
706-01 PF Sun Yellow	1,23	50		88105209	-	1	9,13
707 PF Primrose Yellow	0,615	50		88105259	-	1	4,64
707 PF Primrose Yellow	1,23	50		88104914	-	1	9,13
708 PF Cosmos Blue	0,615	50		88105260	-	1	5,02
708 PF Cosmos Blue	1,23	50		88104915	-	1	9,13
709 PF Ocean Blue	0,615	50		88105261		1	5,02
709 PF Ocean Blue	1,23	50		88104916	-	1	9,13
709-01 PF Euro Blue	1,23	50		88125549	-	1	9,13
710 PF Gold Yellow	1,23	50		88159616	-	1	9,13
711 PF Forest Green	1,23	50		88159617	-	1	9,13
713 PF Grass Green	0,615	50		88105265	-	1	5,02
713 PF Grass Green	1,23	50		88104920	-	1	9,13
714 PF Lime	1,23	50		88104921	-	1	9,13
714-01 PF Lime Tree Gree	1,23	50		88105211	-	1	9,13
714-02 PF Green Yellow	1,23	50		88156313	-	1	9,13
715 PF Cyclamen	1,23	50		88104922	-	1	9,13
716 PF Pink	1,23	50		88104923	-	1	9,13
717 PF Violet	1,23	50		88104924	-	1	9,13
718 PF Chocolate Brown	1,23	50		88104925	-	1	9,13
719 PF Beige	1,23	50		88104926	-	1	9,13
720 PF Grey	0,615	50		88105270	-	1	5,02
720 PF Grey	1,23	50		88104927	-	1	9,13
721 PF Black Matt	0,615	50		88105271	-	5	4,62
721 PF Black Matt	1,23	50		88104928	-	5	8,39
722 PF Light Orange	1,23	50		88158609	-	1	9,13
723 PF Dark Blue	1,23	50		88104930	-	1	9,13
724 PF Cobalt Blue	1,23	50		88104931	-	1	9,13
724-01 PF Alfa Blue	1,23	50		88105215	-	1	9,13





## AVERY 700 PREMIUM POLYMERIC FILM (Vervolg - Suite)

Color Name			Box Label	Ref. Papyrus	Info	Min. Order m.	€/m.
------------	--	--	-----------	--------------	------	---------------	------

### Standard Range - Gamme Standard (Vervolg - Suite)

Dikte - Epaisseur: 80 µ

725 PF Medium Grey	1,23	50		88104932	-	1	9,13
726 PF Medium Red	0,615	50		88105276	-	1	5,02
726 PF Medium Red	1,23	50		88104933	-	1	9,13
730 PF White Matt	1,23	50		88104937	-	5	8,39
731 PF Turquoise	1,23	50		88104938	-	1	9,13
732 PF Light Blue	1,23	50		88104939	-	1	9,13
733 PF Blue	1,23	50		88104940	-	1	9,13
734 PF Kelly Green	1,23	50		88104941	-	1	9,13
735 PF Silver Metallic	0,615	50		88105279	-	1	5,02
735 PF Silver Metallic	1,23	50		88104942	-	1	9,13
735-01 PF Silver	1,23	50		88156315	-	1	9,13
736 PF Gold Metallic	1,23	50		88104943	-	1	9,13
736-01 PF Copper Metallic	1,23	50		88156316	-	1	9,13
737 PF Bright Red	1,23	50		88104944	-	1	9,13
738 PF Bright Orange	1,23	50		88159618	-	1	9,13
739 PF Bright Yellow	0,615	50		88105283	-	1	5,02
739 PF Bright Yellow	1,23	50		88104946	-	1	9,13
739-01 PF Banana Yellow	1,23	50		88156323	-	1	9,13
740 PF Transparent	1,23	50		88104947	-	1	8,39
741 PF Scuba Blue	0,615	50		88105284	-	1	5,02
741 PF Scuba Blue	1,23	50		88104948	-	1	9,13
742 PF Teal	1,23	50		88104949	-	1	9,13
743 PF Deep Red	1,23	50		88104950	-	1	9,13
744 PF Dove Grey	1,23	50		88104951	-	1	9,13
744-01 PF Tele Grey	1,23	50		88105220	-	1	9,13
745 PF Mist	1,23	50		88104952	-	1	9,13
745-01 PF Pale Grey	1,23	50		88105221	-	1	9,13
746 PF Grey Metallic	0,615	50		88105287	-	1	5,02
746 PF Grey Metallic	1,23	50		88104953	-	1	9,13
747 PF Marine Blue	0,615	50		88105288	-	1	5,02
747 PF Marine Blue	1,23	50		88104954	-	1	9,13
748 PF Tomato Red	1,23	50		88125552	-	1	9,13
749 PF Cardinal Red	1,23	50		88104955	-	1	9,13
749-01 PF Crimson Red	1,23	50		88105223	-	1	9,13
749-02 PF Plum Red	1,23	50		88156318	-	1	9,13
750 PF Apple Red	0,615	50		88105290	-	1	5,02
750 PF Apple Red	1,23	50		88104956	-	1	9,13
750-01 PF Strawberry Red	1,23	50		88156319	-	1	9,13
751 PF Azure Blue	1,23	50		88104957	-	1	9,13
752 PF Ultramarine Blue	1,23	50		88104958	-	1	9,13
753 PF Brilliant Blue	1,23	50		88104959	-	1	9,13
754 PF Royal Blue	1,23	50		88104960	-	1	9,13
755 PF Light Green	1,23	50		88159619	-	1	9,13
756 PF Green	1,23	50		88104962	-	1	9,13
757 PF Olive Green	1,23	50		88159620	-	1	9,13
758 PF Ivory	1,23	50		88104964	-	1	9,13
758-01 PF Light Ivory	1,23	50		88105225	-	1	9,13
759 PF Dark Grey	0,615	50		88105299	-	1	5,02
759 PF Dark Grey	1,23	50		88104965	-	1	9,13
759-01 PF Komatsu Grey	1,23	50		88105226	-	1	9,13
759-02 PF Traffic Grey	1,23	50		88156320	-	1	9,13
760 PF Orange Yellow	1,23	50		88159621	-	1	9,13



## AVERY 700 PREMIUM POLYMERIC FILM (Vervolg - Suite)

Color Name			Box Label	Ref. Papyrus	Info	Min. Order m.	€/m.
<b>Standard Range - Gamme Standard (Vervolg - Suite)</b>							
Dikte - Epaisseur: 80 µ							
762 PF Dark Brown	1,23	50		88104968	-	1	9,13
763 PF Regal Red	1,23	50		88159622	-	1	9,13
764 PF Saffron	1,23	50		88104970	-	1	9,13
765 PF Blood Red	0,615	50		88105304	-	1	5,02
765 PF Blood Red	1,23	50		88104971	-	1	9,13
765-01 PF Spicy Red	1,23	50		88156321	-	1	9,13
767 PF Dark Red	0,615	50		88105306	-	1	5,02
767 PF Dark Red	1,23	50		88104973	-	1	9,13
770 PF Red	1,23	50		88104975	-	1	9,13
771 PF Lipstick Red	1,23	50		88104976	-	1	9,13
773 PF Telemagenta	1,23	50		88104978	-	1	9,13
774 PF Magenta	1,23	50		88104979		1	9,13
775 PF Lavender	1,23	50		88104980		1	9,13
777 PF Purple	1,23	50		88104982	-	1	9,13
778 PF Wine Red	1,23	50		88104983	-	1	9,13
780 PF Purple Red	1,23	50		88104985	-	1	9,13
781 PF Emerald	1,23	50		88104986	-	1	9,13
782 PF Pastel Blue	1,23	50		88104987	-	1	9,13
783 PF Scandinia Blue	1,23	50		88104988	-	1	9,13
784 PF Sky Blue	1,23	50		88104989	-	1	9,13
785 PF King Blue	1,23	50		88104990	-	1	9,13
788 PF Black Blue	1,23	50		88104993	-	1	9,13
789 PF Ink Blue	1,23	50		88104994	-	1	9,13
791 PF Deep Blue	1,23	50		88104996	-	1	9,13
792 PF Midnight Blue	1,23	50		88104997	-	1	9,13
792-01 PF Berry Blue	1,23	50		88156322	-	1	9,13
793 PF Classic Blue	1,23	50		88104998	-	1	9,13
794 PF Middle Blue	1,23	50		88104999	-	1	9,13
795 PF Delft Blue	1,23	50		88105000	-	1	9,13
798 PF Petrol	1,23	50		88105002	-	1	9,13

## AVERY 500 EF MONOMERIC EVENT FILM

Monomeer gekalanderde film voor vlakke ondergronden.  
Film Calandré monomère pour des surfaces planes.

AVERY 500 EF MONOMERIC EVENT FILM				
kleuren/couleurs				€/m.
White and Black	4	1,23	4,02	4,94
Glossy Colours	3		4,60	5,66
Metallics	2		4,60	5,66

Color Name			Box Label	Ref. Papyrus	Info	Min. Order m.	€/m.
------------	--	--	-----------	--------------	------	---------------	------

### Glossy Range - Gamme Brillante

Dikte - Epaisseur: 80 µ

501 EF Gloss White	0,615	50	88105247	-	5	2,71
501 EF Gloss White	1,23	50	88104825	-	5	4,94
502 EF Gloss Black	0,615	50	88105248	-	5	2,71
502 EF Gloss Black	1,23	50	88104826	-	5	4,94
503 EF Gloss Geranium Red	1,23	50	88147096	-	1	5,66
504 EF Gloss Primrose Yellow	1,23	50	88104828	-	1	5,66
506 EF Gloss Cactus Green	1,23	50	88104830	-	1	5,66
507 EF Gloss Brown	1,23	50	88168489	-	1	5,66
508 EF Gloss Grey	1,23	50	88168580		1	5,66
509 EF Gloss Orange	1,23	50	88104831	-	1	5,66
510 EF Gloss Bright Blue	1,23	50	88104832	-	1	5,66
511 EF Gloss Cherry Red	1,23	50	88104833		1	5,66
512 EF Gloss Dark Blue	1,23	50	88104834		1	5,66
513 EF Gloss Burgundy	1,23	50	88104835	-	1	5,66
514 EF Gloss Poppy Red	1,23	50	88104836		1	5,66
515 EF Gloss Dark Red	1,23	50	88104837		1	5,66
516 EF Gloss Light Orange	1,23	50	88104838		1	5,66
517 EF Gloss Light Green	1,23	50	88104839	-	1	5,66
518 EF Gloss Grass Green	1,23	50	88168582	-	1	5,66
519 EF Gloss Red	1,23	50	88104840	-	1	5,66
520 EF Gloss Ultrama Blue	1,23	50	88168583	-	1	5,66
521 EF Gloss Intens Blue	1,23	50	88104841	-	1	5,66
522 EF Gloss Violet	1,23	50	88168584		1	5,66
523 EF Gloss Medium Red	1,23	50	88104842	-	1	5,66
524 EF Gloss Magenta	1,23	50	88104843	-	1	5,66
526 EF Gloss Stone Yellow	1,23	50	88104845	-	1	5,66
527 EF Gloss Butter Yell	1,23	50	88104846	-	1	5,66
528 EF Gloss Vivid Blue	1,23	50	88104847	-	1	5,66
529 EF Gloss Light Grey	1,23	50	88168585		1	5,66
530 EF Gloss Dark Grey	1,23	50	88104848	-	1	5,66
531 EF Gloss Lime	1,23	50	88104849	-	1	5,66
532 EF Gloss Kelly Green	1,23	50	88104850		1	5,66
533 EF Gloss Forest Green	1,23	50	88104851	-	1	5,66
534 EF Gloss Turquoise	1,23	50	88168586	-	1	5,66
535 EF Gloss Teal	1,23	50	88104852		1	5,66
536 EF Gloss Mint	1,23	50	88168587		1	5,66
537 EF Gloss Light Blue	1,23	50	88104853	-	1	5,66
538 EF Gloss Gentian Blue	1,23	50	88168588	-	1	5,66
539 EF Gloss Reflex Blue	1,23	50	88104854	-	1	5,66
540 EF Gloss Cobalt Blue	1,23	50	88104855	-	1	5,66



## AVERY 500 EF MONOMERIC EVENT FILM (Vervolg - Suite)

Color Name			Box Label	Ref. Papyrus	Info	Min. Order m.	€/m.
------------	--	--	-----------	--------------	------	---------------	------

### Glossy Range - Gamme Brillante (Vervolg - Suite)

Dikte - Epaisseur: 80 µ

541 EF Gloss Pink	1,23	50		88168589	-	1	5,66
542 EF Gloss Ivory	1,23	50		88168590	-	1	5,66
543 EF Gloss Beige	1,23	50		88104856	-	1	5,66
544 EF Gloss Mist Grey	1,23	50		88104857	-	1	5,66
545 EF Gloss Dove Grey	1,23	50		88104858		1	5,66
546 EF Gloss Silver	1,23	50		88104859	-	1	5,66
547 EF Gloss Gold	1,23	50		88104860	-	1	5,66
548 EF Gloss Nut Brown	1,23	50		88168591		1	5,66

### Matt Removable Range - Gamme Mate removable

Dikte - Epaisseur: 80 µ

501 EF Matt White	0,615	50		88105249	-	5	2,71
501 EF Matt White	1,23	50		88104861	-	5	4,94
502 EF Matt Black	0,615	50		88105250	-	5	2,71
502 EF Matt Black	1,23	50		88104862	-	5	4,94
503 EF Matt Geranium Red	1,23	50		88147095	-	1	5,66
504 EF Matt Primrose Yel	1,23	50		88104864	-	1	5,66
505 EF Matt Blue	1,23	50		88104865	-	1	5,66
506 EF Matt Cactus Green	1,23	50		88104866	-	1	5,66
507 EF Matt Brown	1,23	50		88104867	-	1	5,66
508 EF Matt Grey	1,23	50		88104868	-	1	5,66
509 EF Matt Orange	1,23	50		88104869	-	1	5,66
510 EF Matt Bright Blue	1,23	50		88104870		1	5,66
511 EF Matt Cherry Red	1,23	50		88104871	-	1	5,66
512 EF Matt Dark Blue	1,23	50		88104872	-	1	5,66
513 EF Matt Burgundy Red	1,23	50		88104873	-	1	5,66
514 EF Matt Poppy Red	1,23	50		88104874	-	1	5,66
515 EF Matt Dark Red	1,23	50		88104875	-	1	5,66
516 EF Matt Light Orange	1,23	50		88104876	-	1	5,66
517 EF Matt Light Green	1,23	50		88104877	-	1	5,66
518 EF Matt Grass Green	1,23	50		88104878	-	1	5,66
519 EF Matt Red	1,23	50		88104879	-	1	5,66
520 EF Matt Ultramar Blu	1,23	50		88104880	-	1	5,66
521 EF Matt Intense Blue	1,23	50		88104881	-	1	5,66
522 EF Matt Violet	1,23	50		88104882	-	1	5,66
523 EF Matt Medium Red	1,23	50		88104883	-	1	5,66
524 EF Matt Magenta	1,23	50		88104884	-	1	5,66
526 EF Matt Stone Yellow	1,23	50		88104886	-	1	5,66
527 EF Matt Butter Yello	1,23	50		88125565	-	1	5,66
528 EF Matt Vivid Blue	1,23	50		88104887	-	1	5,66
529 EF Matt Light Grey	1,23	50		88104888	-	1	5,66
530 EF Matt Dark Grey	1,23	50		88104889	-	1	5,66
531 EF Matt Lime	1,23	50		88104890	-	1	5,66
532 EF Matt Kelly Green	1,23	50		88104891		1	5,66
533 EF Matt Forest Green	1,23	50		88104892	-	1	5,66
534 EF Matt Turquoise	1,23	50		88104821	-	1	5,66
535 EF Matt Teal	1,23	50		88104893	-	1	5,66
536 EF Matt Mint	1,23	50		88104894		1	5,66
537 EF Matt Light Blue	1,23	50		88104895	-	1	5,66
538 EF Matt Gentian Blu	1,23	50		88104896	-	1	5,66
539 EF Matt Reflex Blue	1,23	50		88104897	-	1	5,66
540 EF Matt Cobalt Blue	1,23	50		88104898	-	1	5,66



## AVERY 500 EF MONOMERIC EVENT FILM (Vervolg - Suite)

Color Name			Box Label	Ref. Papyrus	Info	Min. Order m.	€/m.
------------	--	--	-----------	--------------	------	---------------	------

### Matt Removable Range- Gamme Mate removable (Vervolg - Suite)

Dikte - Epaisseur: 80 µ

541 EF Matt Pink	1,23	50		88104899	-	1	5,66
542 EF Matt Ivory	1,23	50		88104900	-	1	5,66
543 EF Matt Beige	1,23	50		88104901	-	1	5,66
544 EF Matt Mist Grey	1,23	50		88104902	-	1	5,66
545 EF Matt Dove Grey	1,23	50		88104903	-	1	5,66
546 EF Matt Silver	1,23	50		88104904	-	1	5,66
547 EF Matt Gold	1,23	50		88104905	-	1	5,66
548 EF Matt Nut Brown	1,23	50		88104906	-	1	5,66



### Matt Permanent Range - Gamme Mate Permanente

Dikte - Epaisseur: 80 µ

501 EF Matt PERM White	1,23	50	LB0020001	88306780		5	4,1
502 EF Matt PERM Black	1,23	50	LB0420001	88306781	-	5	4,1
503 EF Matt PERM Geranium Red	1,23	50	LB0010001	88306825		5	4,84
504 EF Matt PERM Primrose Yel	1,23	50	LB0460001	88306782		5	4,84
505 EF Matt PERM Blue	1,23	50	LB0470001	88306784		1	4,84
506 EF Matt PERM Cactus Green	1,23	50	LB0450001	88306785		1	4,84
507 EF Matt PERM Brown	1,23	50	LB0480001	88306786		1	4,84
508 EF Matt PERM Grey	1,23	50	LB0490001	88306787		1	4,84
509 EF Matt PERM Orange LF	1,23	50	LB0500001	88306788		1	4,84
510 EF Matt PERM Bright Blue	1,23	50	LB0210001	88306789		1	4,84
511 EF Matt PERM Cherry Red	1,23	50	LB0570001	88306790		1	4,84
512 EF Matt PERM Dark Blue	1,23	50	LB0580001	88306791		1	4,84
513 EF Matt PERM Burgundy Red	1,23	50	LB0510001	88306792		1	4,84
514 EF Matt PERM Poppy Red	1,23	50	LB0220001	88306793		1	4,84
515 EF Matt PERM Dark Red	1,23	50	LB0250001	88306794		1	4,84
516 EF Matt PERM Light Orange	1,23	50	LB0230001	88306795		1	4,84
517 EF Matt PERM Light Green	1,23	50	LB0240001	88306796		1	4,84
518 EF Matt PERM Grass Green	1,23	50	LB0520001	88306797		1	4,84
519 EF Matt PERM Red	1,23	50	LB0260001	88306798		1	4,84
520 EF Matt PERM Ultramar Blue	1,23	50	LB0530001	88306799		1	4,84
521 EF Matt PERM Intense Blue	1,23	50	LB0540001	88306800		1	4,84
522 EF Matt PERM Violet	1,23	50	LB0550001	88306801		1	4,84
523 EF Matt PERM Medium Red	1,23	50	LB0270001	88306802		1	4,84
524 EF Matt PERM Magenta	1,23	50	LB0560001	88306803		1	4,84
526 EF Matt PERM Stone Yellow	1,23	50	LB0150001	88306804		1	4,84
527 EF Matt PERM Butter Yello	1,23	50	LB0280001	88306824		1	4,84
528 EF Matt PERM Vivid Blue	1,23	50	LB0440001	88306805		1	4,84
529 EF Matt PERM Light Grey	1,23	50	LB0200001	88306806		1	4,84
530 EF Matt PERM Dark Grey	1,23	50	LB0590001	88306807		1	4,84
531 EF Matt PERM Lime	1,23	50	LB0160001	88306808		1	4,84
532 EF Matt PERM Kelly Green	1,23	50	LB0290001	88306809		1	4,84
533 EF Matt PERM Forest Green	1,23	50	LB0300001	88306810		1	4,84
534 EF Matt PERM Turquoise	1,23	50	LB0310001	88306777		1	4,84
535 EF Matt PERM Teal	1,23	50	LB0320001	88306811		1	4,84
536 EF Matt PERM Mint	1,23	50	LB0330001	88306812		1	4,84
537 EF Matt PERM Light Blue	1,23	50	LB0170001	88306813		1	4,84
538 EF Matt PERM Gentian Blu	1,23	50	LB0340001	88306814		1	4,84
539 EF Matt PERM Reflex Blue	1,23	50	LB0350001	88306815		1	4,84
540 EF Matt PERM Cobalt Blue	1,23	50	LB0360001	88306816		1	4,84
541 EF Matt PERM Pink	1,23	50	LB0180001	88306817		1	4,84
542 EF Matt PERM Ivory LF	1,23	50	LB0370001	88306818		1	4,84









## AVERY 500 EF MONOMERIC EVENT FILM (Vervolg - Suite)

Color Name			Box Label	Ref. Papyrus	Info	Min. Order m.	€/m. 
------------	---	---	-----------	--------------	------	---------------	--

### Matt Permanent Range - Gamme Mate Permanente (Vervolg - Suite)

Dikte - Epaisseur: 80 µ

543 EF Matt PERM Beige	1,23	50	LB0190001	88306819		1	4,84
544 EF Matt PERM Mist Grey	1,23	50	LB0380001	88306820		1	4,84
545 EF Matt PERM Dove Grey	1,23	50	LB0390001	88306779		1	4,84
546 EF Matt PERM Silver	1,23	50	LB0400001	88306821		1	4,84
547 EF Matt PERM Gold	1,23	50	LB0410001	88306822		1	4,84
548 EF Matt PERM Nut Brown	1,23	50	LB0430001	88306823		1	4,84



## WINDOW FILMS

Color Name			Box Label	Ref. Papyrus	Info	Min. Order m.	€/m. 
------------	--	--	-----------	--------------	------	---------------	----------

### Cast Range - Gamme Coulée

#### AVERY ETCHED GLASS

Imitatie gezandstraald glas - gegoten kwaliteit - zeer lange duurzaamheid (7-9 jaar).  
Imitation verre sablé - qualité coulée - durabilité très longue (7-9 ans\*).  
Dikte - Epaisseur: 60 µ



Etched Glass - transparent sand	1,23	50		88104744	-	1	31,8
---------------------------------	------	----	--	----------	---	---	------

#### AVERY FROSTED GLASS (cast)

Imitatie bevroren glas - gegoten kwaliteit - zeer lange duurzaamheid (7-9 jaar).  
Imitation verre givré - qualité coulée - durabilité très longue (7-9 ans\*).  
Dikte - Epaisseur: 80 µ



Frosted Glass - transparent frozen	1,23	50		88104743	-	1	31,8
------------------------------------	------	----	--	----------	---	---	------

### Polymeric Range - Gamme Polymère

#### AVERY DUSTED GLASS (polymeric)

Imitatie gezandstraald glas - polymeer gekalanderde kwaliteit, Duurzaamheid: 5-7 jaar.  
Imitation verre sablé - qualité calandré polymère, Durabilité: 5-7 ans\*.  
Dikte - Epaisseur: 80 µ



Dusted Glass	1,23	50		88104745	-	5	9,27
Dusted Glass EA	1,52	50		88125582	-	1	13,16
Dusted Glass EARS	1,37	50		88105072	-	1	17,27

#### AVERY CRYSTAL GLASS (polymeric)

Imitatie bevroren glas - polymeer gekalanderde kwaliteit, Duurzaamheid: 5-7 jaar.  
Imitation verre givré - qualité calandré polymère, Durabilité: 5-7 ans\*.  
Dikte - Epaisseur: 80 µ



Crystal Glass	1,23	50		88104746	-	5	9,76
Crystal Glass EA	1,52	50		88125581	-	1	13,16

### Polyester Range - Gamme Polyester

#### AVERY GLOSS POLYESTER

Zelfklevende, glanzende metallic polyester. Polyester métallique brillant, adhésif.  
Dikte - Epaisseur: 25 µ



Gloss Silver	1,23	50	CD111002	88104760	-	1	9,8
Gloss Gold	1,23	50	CE3450002	88105246	-	1	9,8



## Avery SignFlex™

Conformiteit op (truck)banners. Weerstaat vouwen en dagelijks meerdere openingen. Uitstekende dimensionele stabiliteit. Bestand tegen extreme koude en warme temperaturen. De SignFlex White biedt uitstekende afdrukbaarheid op de meeste digitale printers. Kleurechtheid en UV-bestendigheid.

Conformité sur bâches. Résiste au pliage et aux multiples ouvertures quotidienne. Excellente stabilité dimensionnelle. Résiste aux températures extrêmes froides et chaudes. Le SignFlex White offre une grande imprimabilité sur les principales imprimantes digitales. Solidité des couleurs et résistance aux UV.

### SignFlex

Dikte - Epaisseur: 75 µ

Avery Signflex White	1,23	50	BU0490001	88316110	NEW	1	22,92
Avery Signflex Black	1,23	50	BU0280002	88316107	NEW	1	22,92
Avery Signflex Red	1,23	50	BU0300002	88316113	NEW	1	22,92
Avery Signflex Blue	1,23	50	BU0290002	88316114	NEW	1	22,92
Avery Signflex Yellow	1,23	50	BU0310002	88316115	NEW	1	22,92
Avery Signflex Green	1,23	50	BU0330002	88316116	NEW	1	22,92

Color Name			Box Label	Ref. Papyrus	Info	Min. Order m.	€/m <sup>2</sup>	€/roll 
------------	--	--	-----------	--------------	------	---------------	------------------	------------

Avery Signflex Dol Perm	1,23	50	BU0340002	88316117	NEW	50	20,5	1260,75
-------------------------	------	----	-----------	----------	-----	----	------	---------



## CAST TRANSLUCENT FILMS

AVERY 5500 QM TRANSLUCENT FILMS				
kleuren/couleurs				€/m.
White and Black	10	1,23	27,97	34,40
Glossy Colours	8		27,97	34,40
Metallics	5		27,97	34,40

Color Name			Box Label	Ref. Papyrus	Info	Min. Order m.	€/m.
<b>AVERY 5500 QM TRANSLUCENT FILMS - AVERY 5500 QM - FILMS TRANSLUCIDES</b>							

### Gegoten translucent film. - Film translucide coulé.

Dikte - Epaisseur: 80 µ

White	1,23	25	5500	88162507	-	1	34,4
Black	1,23	25	5501	88162514	-	1	34,4
Sun Yellow	1,23	25	5503	88162515		1	34,4
Yellow	1,23	25	5504-01	88162518	-	1	34,4
Citrus Yellow	1,23	25	5505	88162519	-	1	34,4
Medium Red	1,23	25	5506	88162520		1	34,4
Curry Yellow	1,23	25	5507-01	88162521		1	34,4
Kelly Green	1,23	25	5508	88162522	-	1	34,4
Sapphire Blue	1,23	25	5509	88162523		1	34,4
Golden Yellow	1,23	25	5510-01	88162524	-	1	34,4
Gentian Blue	1,23	25	5512	88162525	-	1	34,4
Yellow Orange	1,23	25	5513-01	88162526	-	1	34,4
Fire Orange	1,23	25	5514	88162527	-	1	34,4
Tangerine Orange	1,23	25	5515-01	88162528		1	34,4
Deep Orange	1,23	25	5516-01	88162529		1	34,4
Sunse Orange	1,23	25	5517-01	88162531	-	1	34,4
Coral Red	1,23	25	5518	88162532		1	34,4
Apple Red	1,23	25	5519	88162537	-	1	34,4
Ruby Red	1,23	25	5520	88162555		1	34,4
Red	1,23	25	5521	88162556	-	1	34,4
Oriental Red	1,23	25	5522	88162561	-	1	34,4
Cherry Red	1,23	25	5523	88162562		1	34,4
Scarlet Red	1,23	25	5524	88162569		1	34,4
Fire Red	1,23	25	5525	88162587	-	1	34,4
Garnet Red	1,23	25	5526	88162588		1	34,4
Strawberry Red	1,23	25	5527	88162589		1	34,4
Sharp Red	1,23	25	5528	88162590	-	1	34,4
Wine Red	1,23	25	5530	88162605		1	34,4
Tulip pink	1,23	25	5531	88162606		1	34,4
Lavender	1,23	25	5533	88162607		1	34,4
Rosewine	1,23	25	5534	88162608		1	34,4
Grape Purple	1,23	25	5536	88162609		1	34,4
Delft Blue	1,23	25	5541	88162612		1	34,4
Night Blue	1,23	25	5543	88162613		1	34,4
Rain Blue	1,23	25	5544	88162614	-	1	34,4
Steel Blue	1,23	25	5545	88162615	-	1	34,4
Shadow Blue	1,23	25	5546	88162616		1	34,4
Azure Blue	1,23	25	5547	88162617	-	1	34,4
Electric Blue	1,23	25	5548	88162618		1	34,4





## CAST TRANSLUCENT FILMS (Vervolg - Suite)

Color Name			Box Label	Ref. Papyrus	Info	Min. Order m.	€/m.
<b>AVERY 5500 QM TRANSLUCENT FILMS (Vervolg - Suite)</b>							
Sailing Blue	1,23	25	5549	88162619		1	34,4
Island Blue	1,23	25	5550	88162620	-	1	34,4
Primrose Yellow	1,23	25	5551	88162621		1	34,4
Shocking Blue	1,23	25	5552	88162622		1	34,4
Mediterranean Blue	1,23	25	5553	88162667		1	34,4
Ocean Green	1,23	25	5555	88162668	-	1	34,4
Forest Green	1,23	25	5558	88162669		1	34,4
Autumn Green	1,23	25	5560	88162670	-	1	34,4
Summer Green	1,23	25	5561	88162671	-	1	34,4
Yellow Green	1,23	25	5562	88162672		1	34,4
Pine Green	1,23	25	5563	88162673		1	34,4
Lime Green	1,23	25	5565	88162674	-	1	34,4
Mouse Grey	1,23	25	5569	88162677	-	1	34,4
Smoke Grey	1,23	25	5570	88162681		1	34,4
Ash Grey	1,23	25	5571	88162682		1	34,4
Pearl	1,23	25	5572-01	88162685		1	34,4
Beige Grey	1,23	25	5573	88162688	-	1	34,4
Copper Brown	1,23	25	5574	88162692		1	34,4
Chocolate Brown	1,23	25	5579	88162694		1	34,4
Sky Blue	1,23	25	5581	88162696	-	1	34,4
Silver Metallic	1,23	25	5590	88162698		1	34,4
Gold Metallic	1,23	25	5591	88162700		1	34,4

## AVERY 5500 QM TRANSLUCENT FILMS - COLOURMATCH

Color Name			Nbre Rolls	Ref. Papyrus	Info	Min. Order m.	€/m.
5500 QM Colourmatch	1,23	50	1 roll	1,95		50	74,61
5500 QM Colourmatch	1,23	50	2 rolls	1,85		100	70,78
5500 QM Colourmatch	1,23	50	3 rolls	1,5		150	57,39
5500 QM Colourmatch	1,23	50	4 rolls	1,35		200	51,65
5500 QM Colourmatch	1,23	50	5-8 rolls	1,25		250	47,83
5500 QM Colourmatch	1,23	50	9-16 rolls	1,1		450	42,09
5500 QM Colourmatch	1,23	50	>16 rolls	1		800	38,26



## CAST TRANSLUCENT LED FILMS (Vervolg - Suite)

AVERY 5600 LD TRANSLUCENT FILMS				
kleuren/couleurs				€/m.
White and Black	10	1,23	29,89	36,77
Glossy Colours	8		29,89	36,77
Metallics	5		29,89	36,77

Color Name			Box Label	Ref. Papyrus	Info	Min. Order m.	€/m.
------------	--	--	-----------	--------------	------	---------------	------

### AVERY 5600 LED TRANSLUCENT FILMS - AVERY 5600 LD - FILMS TRANSLUCIDES

Gegoten translucent film voor led-verlichting. - Film translucide coulé pour éclairage led.

Dikte - Epaisseur: 70 µ

White	1,23	50	5600	88201638		36,77
Black	1,23	50	5601	88201645	-	36,77
Yellow	1,23	50	5604	88201646		36,77
Golden Yellow	1,23	50	5610	88201647		36,77
Deep Orange	1,23	50	5616	88201652		36,77
Apple Red	1,23	50	5619	88201654		36,77
Cherry Red	1,23	50	5620	88201655		36,77
Red	1,23	50	5621	88201656		36,77
Azure Blue	1,23	50	5647	88201657		36,77
Island Blue	1,23	50	5650	88201658		36,77
Shocking Blue	1,23	50	5652	88201659		36,77
Autumm Green	1,23	50	5660	88201660		36,77
Summer Green	1,23	50	5661	88201661		36,77
Pine Green	1,23	50	5663	88201662		36,77



## POLYMERIC TRANSLUCENT FILMS

AVERY 4500 TRANSLUCENT FILMS				
kleuren/couleurs				€/m.
White and Black	7	1,23	12,17	14,97
Glossy Colours	7		12,17	14,97
Metallics	5		12,17	14,97



Color Name			Box Label	Ref. Papyrus	Info	Min. Order m.	€/m.
------------	--	--	-----------	--------------	------	---------------	------

### AVERY 4500 TRANSLUCENT FILMS - AVERY 4500 - FILMS TRANSLUCIDES

Polymeer gekalanderde, translucient film.- Film translucide calandré polymère.  
Dikte - Epaisseur: 90 µ

White	1,23	50	4500	88104795	-	1	14,97
Black	1,23	50	4501	88104796	-	1	14,97
Yellow	1,23	50	4502	88104797	-	1	14,97
Lemon Yellow	1,23	50	4503	88168593	-	1	14,97
Chrome Yellow	1,23	50	4504	88104798	-	1	14,97
Red	1,23	50	4506	88104800	-	1	14,97
Light Green	1,23	50	4507	88168594	-	1	14,97
Pepper Red	1,23	50	4508	88168596		1	14,97
Cardinal Red	1,23	50	4509	88104802	-	1	14,97
Pink	1,23	50	4511	88104804		1	14,97
Blue	1,23	50	4512	88104805	-	1	14,97
Violet	1,23	50	4513	88104806		1	14,97
Green	1,23	50	4516	88104808	-	1	14,97
Dark Blue	1,23	50	4517	88104809		1	14,97
Sapphire Blue	1,23	50	4518	88104810	-	1	14,97
Grey	1,23	50	4519	88104811		1	14,97
Wine Red	1,23	50	4520	88168605	-	1	14,97
Burgundy	1,23	50	4522	88168608	-	1	14,97
Light Blue	1,23	50	4523	88168609	-	1	14,97
Royal Blue	1,23	50	4525	88168610		1	14,97
Ocean Blue	1,23	50	4527	88104814	-	1	14,97
Reflex Blue	1,23	50	4528	88104815	-	1	14,97
Deep Blue	1,23	50	4529	88168611		1	14,97
Aqua	1,23	50	4531	88104816		1	14,97
Forest Green	1,23	50	4532	88104817	-	1	14,97
Meadow Green	1,23	50	4533	88104818		1	14,97
Pacific Green	1,23	50	4534	88168612		1	14,97
Pigeon Grey	1,23	50	4535	88104819	-	1	14,97
Medium Grey	1,23	50	4536	88168614	-	1	14,97
Chocolate	1,23	50	4537	88168615		1	14,97
Turquoise	1,23	50	4539	88168616		1	14,97
Silver	1,23	50	4540	88104822	-	1	14,97
Gold	1,23	50	4541	88168617	-	1	14,97
Yellow Orange	1,23	50	4542	88168618	-	1	14,97
Pumpkin Orange	1,23	50	4543	88168619		1	14,97
Sunset Orange	1,23	50	4544	88168620	-	1	14,97

## SPECIALTY FILMS

Color Name			Box Label	Ref. Papyrus	Info	Min. Order m.	€/m. 
------------	---	---	-----------	--------------	------	---------------	--

### AVERY 500 FLUOR FILMS - AVERY 500 - FILMS FLUOS

**Monomeer gekalanderde fluo film. - Film fluo calandré monomère.**

Dikte - Epaisseur: 130 µ



Fluor Yellow 500-2	1,23	50	CE3560003	88104775	-	1	18,55
Fluor Orange Red 500-6	1,23	50	CE3550003	88104776	-	1	18,55

### AVERY 900 FLUOR FILMS - AVERY 900 FILMS FLUOS

**Gegoten fluo film. - Film fluo coulé.**

Dikte - Epaisseur: 110 µ







Fluor Red 900-3	1,23	50	CE1120001	88104778	-	1	30,85
-----------------	------	----	-----------	----------	---	---	-------

### AVERY 1200 BANNER FILMS - AVERY 1200 - FILMS POUR BÂCHES

**Film voor spandoeken (verwijderbaar tot 2 jaar). - Film pour banderoles (enlevable jusqu'à 2 ans).**

Dikte - Epaisseur: 130 µ



1201 White	1,23	50	CE3630003	88104761	-	1	9,34
1202 Black	1,23	50	CE3640002	88104762	-	1	9,34
1205 Geranium Red	1,23	50	CE3670002			50	9,34
1206 Medium Red	1,23	50	CE3680002	88104765		1	9,34
1209 Stone Yellow	1,23	50	CE3710002			50	9,34
1210 Light Green	1,23	50	CE3720002			50	9,34
1217 Dark Blue	1,23	50	CE3790002	88104772	-	1	9,34

### AVERY SIGNMASK FILMS - FILMS DE MASQUAGE AVERY

**Signmask Light Blue: Sjabloonfilm aanbevolen voor vlakke en gebogen ondergronden en baches. - Film pochoir recommandé pour des surfaces planes et courbes et des bâches.**

Dikte - Epaisseur:



Light Blue	1,23	50	CE8760001	88104757	-	1	5,66
------------	------	----	-----------	----------	---	---	------

### AVERY FUNCTIONAL FILMS - Avery 7500 - FILMS DE PROTECTION





**Beschermingsfilm voor de buitenkant van voertuigen. - Films de protection pour l'extérieur des voitures.**

Dikte - Epaisseur: 150-325 µ





7541 PVC Transparent 150µ	1	50		88245639	-	1	14,59
7521 PU Transparent 200µ	1	50				50	59,78
7554 BlackSatinMat 150µ - Embossed fine grain	1	40		88245636	-	1	12,27















## REFLECTIVE FILMS

Color Name			Box Label	Ref. Papyrus	Info	Min. Order m.	€/m.
<b>AVERY HV 1200 / HV 1200E Reflective Film - AVERY HV 1200 / HV 1200E Films Réfléchissants</b>							
Gegoten retro-reflecterende film zonder (HV 1200) of met (HV 1200 E) UN ECE 104/43 logo. - Film rétro-réfléchissant coulé sans (HV 1200) ou avec (HV 1200 E) logo UN ECE 104/43.							
Dikte - Epaisseur: 90 µ   							
HV 1200 E-688-R Blue	1,22	25	CA5870001	88104751	End of Stock	1	41,93



## Avery V-4000 Retro-Reflective Films - EA - V-4000 Films Retro-Réfléchissants Avery - EA

Gegoten retro-reflecterende film zonder (V 4000) of met (v 4000 E) UN ECE 104/43 logo. Easy-Apply Lijm - Film rétro-réfléchissant coulé sans (V 4000) ou avec (V 4000 E) logo UN ECE 104/43. Colle Easy-Apply							
Dikte - Epaisseur: 90 µ   							
V 4000 - 101 E White	1,22	25	BO2290001	88268067	-	1	39,22
V 4000 - 190 E Black	1,22	25	BO2450001	88268087	-	1	39,22
V 4000 - 688 E Blue	1,22	25	BO2330001	88268088	-	1	39,22
V 4000 - 440 E Red	1,22	25	BO2350001	88268089	-	1	39,22
V 4000 - 235 E Yellow	1,22	25	BO2340001	88268090	-	1	39,22
V 4000 - 360 E Orange	1,22	25	BO2360001	88268091	-	1	39,22
V 4000 - 101 White	1,22	25	B02310001	88268092	-	1	33,45
V 4000 - 190 Black	1,22	25	B02380001	88268094	-	1	33,45
V 4000 - 688 Blue	1,22	25	B02390001	88268095	-	1	33,45
V 4000 - 440 Red	1,22	25	B02410001	88268097	-	1	33,45
V 4000 - 235 Yellow	1,22	25	B02420001	88268096	-	1	33,45
V 4000 - 360 Orange	1,22	25	B02430001	88268098	-	1	33,45

## Avery V-4000 Retro-Reflective Films - Perm - V-4000 Films Retro-Réfléchissants Avery - Perm

Gegoten retro-reflecterende film zonder (V 4000) of met (v 4000 E) UN ECE 104/43 logo. Permanente Lijm - Film rétro-réfléchissant coulé sans (V 4000) ou avec (V 4000 E) logo UN ECE 104/43. Colle Permanente							
Dikte - Epaisseur: 90 µ   							
V 4000 - 101 E - Perm - White	1,22	25	BO2290001	88297709		1	35,49
V 4000 - 190 E - Perm - Black	1,22	25	BO2450001	88297710		1	35,49
V 4000 - 688 E - Perm - Blue	1,22	25	BO2330001	88297711		1	35,49
V 4000 - 440 E - Perm - Red	1,22	25	BO2350001	88297712		1	35,49
V 4000 - 235 E - Perm - Yellow	1,22	25	BO2340001	88297713		1	35,49
V 4000 - 360 E - Perm - Orange	1,22	25	BO2360001	88297714		1	35,49
V 4000 - 101 - Perm - White	1,22	25	B02310001	88297715	-	1	29,79
V 4000 - 190 - Perm - Black	1,22	25	B02380001	88297716		1	29,79
V 4000 - 688 - Perm - Blue	1,22	25	B02390001	88297717		1	29,79
V 4000 - 440 - Perm - Red	1,22	25	B02410001	88297719		1	29,79
V 4000 - 235 - Perm - Yellow	1,22	25	B02420001	88297718		1	29,79
V 4000 - 360 - Perm - Orange	1,22	25	B02430001	88297720		1	29,79

## REFLECTIVE FILMS



Color Name			Box Label	Ref. Papyrus	Info	Min. Order m.	€/m. 
------------	---	---	-----------	--------------	------	---------------	--

### Avery VisiFlex V 8000 Reflective Film - Avery VisiFlex V 8000 / HV 1200E Films Réfléchissants



Digitaal beprintbare reflecterende film met uitstekende zichtbaarheid zowel overdag als bij nacht, Geschikt voor veiligheids- en noodvoertuigen. - Réflectivité Omnidirectionnelle remarquable et éclatante pour les véhicules de sécurité et d'urgence - Film Imprima-ble.

Dikte - Epaisseur: 533 – 660 µm



V 8000 White	1,22	22,86	BF9400002	88268100	-	1	60,59
V 8005 Blue	1,22	22,86	BF9480002	88268101	-	1	60,59
V 8007 Green	1,22	22,86	BF9470002	88268104	-	1	60,59
V 8008 Red	1,22	22,86	BF9460002	88268106	-	1	60,59
V 8013 Fluor Yellow Green	1,22	22,86	BG0040002	88268107	-	1	60,59
V 8014 Fluor Orange	1,22	22,86	BG0010002	88268108	-	1	60,59
V 8000 Chevron - White/Red - Left Marking	1,2	22,86	BQ2240003	88293633		1	74,27
V 8000 Chevron - White/Red - Right Marking	1,2	22,86	BQ2290003	88293634		1	74,27
V 8000 Chevron - Yellow/Red - Left Marking	1,2	22,86	BQ2230003	88293635	-	1	101,85
V 8000 Chevron - Yellow/Red - Right Marking	1,2	22,86	BQ2220003	88293636	-	1	101,85

## STRIPING and CONTOURMARKING

Color Name			Box Label	Ref. Papyrus	Info	Min. Order m.	€/Roll 
------------	---	---	-----------	--------------	------	---------------	---

### AVERY V-6700-B CONSPICUITY TAPE - AVERY V6700-B

Speciaal voor "striping and contourmarking" - Geschikt voor harde, vlakke of licht gebogen ondergronden ECE 104R norm - Classe C - Prismatisch reflecterend - 8 Jaaren

Spécialement conçu pour les bandes de balisage et le marquage des contours de camions - Convient pour les surfaces dures, planes et légèrement courbées - Norme ECE 104R - Classe C - Réfléchissant prismatic - 8 ans

Dikte - Epaisseur: 228 – 280 µ



White	0,051	50	CA6240002	88105227	-	50	132,6
Yellow	0,051	50	CA6170002	88105228	-	50	132,6
Red	0,051	50	CA6250002	88105229	-	50	132,6

### AVERY V-6790 CONSPICUITY TAPE - AVERY V6790

Film haute visibilité pour la signalisation de contours de véhicules

Speciaal ontworpen voor het aanbrengen strips en contourmarkering op (vracht)wagens met flexibele ondergrond (PVC zeildoek)

Spécialement conçu pour les bandes de balisage et le marquage des contours pour les véhicules à rideaux latéraux en PVC - Norme ECE 104R - Classe C - Réfléchissant prismatic - 3 ans

Dikte - Epaisseur: 330 – 381 µ



White	0,051	50	BB7030001	88268109	-	50	152,48
Yellow	0,051	50	BB7020001	88268110	-	50	152,48
Red	0,051	50	BB6980001	88268111	-	50	152,48

# Papyrus Viscom

Prijslijst / Liste de prix  
Sign Media Hexis

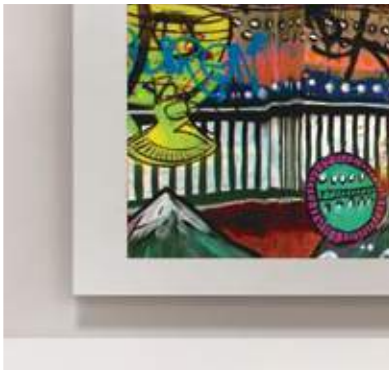

**PAPYRUS**   
Your partner in Visual Communication

# Sign Media Hexis

<b>HEXIS SKINTAC CAST HX30000</b>	
RANGE 1 : Variochrome / Iridescent / Pearlescent . . . . .	43
RANGE 2 : Carbon / Alligator / Leather / Brushed . . . . .	43, 44
RANGE 3 : Super Chrome . . . . .	44
RANGE 3 : Super Chrome Satin . . . . .	44
<b>HEXIS SKINTAC CAST HX20000</b>	
RANGE 1 : Black and White . . . . .	45
RANGE 2 : Gloss Colours / Matt Colours / Glitters . . . . .	45
RANGE 2 : Gloss Colours / Matt Colours / Glitters (Vervolg - Suite) . . . . .	46, 47
<b>HEXIS SMARTAC CAST KG8000</b>	
RANGE 1 : White, Black, Clear . . . . .	48
RANGE 2 : Colours. . . . .	48
RANGE 2 : Colours (Vervolg - Suite) . . . . .	49
RANGE 3 : Metallics . . . . .	49
<b>HEXIS SUPTAC POLYMERIC S5000</b>	
RANGE 3 : Metallic . . . . .	50
RANGE 1 : White, Black, Clear . . . . .	50
RANGE 2 : Colours. . . . .	50
RANGE 2 : Colours (Vervolg - Suite) . . . . .	51
RANGE 3 : Metallics . . . . .	51
<b>HEXIS SUPTAC POLYMERIC HXS5000</b>	
RANGE 1 : White, Black . . . . .	52
RANGE 2 : Colours. . . . .	52
RANGE 3 : Special . . . . .	52
<b>HEXIS ECOTAC MONOMERIC E3000</b>	
RANGE 1 : White, Black, Clear . . . . .	53
RANGE 2 : Colours. . . . .	53, 54
RANGE 3 : Metallics . . . . .	54
<b>HEXIS ECOTAC MONOMERIC High Tack - VCRE 3800</b>	
RANGE 1 : White, Black . . . . .	55
RANGE 2 : Colours. . . . .	55
<b>WINDOW FILMS - HEXIS ETCHED GLASS</b>	
HEXIS CAST ETCHED GLASS . . . . .	55
HEXIS HEX'PRESS POLYMERIC ETCHED GLASS . . . . .	55
HEXIS POLYMERIC ETCHED GLASS . . . . .	55
HEXIS CRISTAL C4000 TRANSPARENT . . . . .	56
<b>TRANSLUCENT FILMS</b>	
HEXIS T5000 TRANSLUCENT - Colours . . . . .	56
HEXIS TRANSLUCENT - Block Out . . . . .	56
<b>REFLECTIVE FILMS</b>	
HEXIS R3000 REFLECTIVE FILMS . . . . .	57
<b>SPECIALTY FILMS</b>	
HEXIS FLUO F610 . . . . .	57
HEXIS METALLIC POLYESTER P6000 . . . . .	57
HEXIS BLACKBOARD. . . . .	57
HEXIS WHITEBOARD - LONG TERM ERASABLE FILM . . . . .	57
HEXIS MAGNETIC FILM . . . . .	58
HEXIS MASKING FILM . . . . .	58
Hexis Truck Banner Film . . . . .	58
<b>APPLICATION TAPES</b>	
HEXIS PAPER APPLICATION TAPE. . . . .	58
HEXIS FILM APPLICATION TAPE . . . . .	58
<b>PROTECTIVE and SAFETYFILMS</b>	
AUTOMOTIVE SOLAR FILMS (WINDOWS) - FILMS SOLAIRES AUTOMOBILE (FENETRES). . . . .	59
AUTOMOTIVE PROTECTIVE FILMS - FILMS DE PROTECTION AUTOMOBILE (CARROSSERIE). . . . .	59
BUILDING SOLAR FILMS (WINDOWS) - FILMS SOLAIRES BATIMENT (FENETRES) . . . . .	59
<b>HEXIS PURE ZONE ANTIMICROBIAL FILM</b>	
Antimicrobial laminate. . . . .	60





## HEXIS SKINTAC CAST HX30000

Meerlagige gegoten vinyl voor car wrapping en decoratie van andere objecten.  
Vinyle coulé multicouche pour la personnalisation de véhicules ou d'objets.

Hexis Skintac Cast HX30000				
kleuren/couleurs		m.	€/m <sup>2</sup>	€/m.
RANGE 1 : Variochrome / Iridescent / Pearlescent	10	1,52	24,72	37,57
RANGE 2 : Carbon / Alligator / Leather / Brushed	10	1,52	34,85	52,97
		1,37		46,25
RANGE 3 : Super Chrome	10	1,37	60,47	82,85

### RANGE 1 : Variochrome / Iridescent / Pearlescent

Color Name			Box Label	Ref. Papyrus	Info	Min. Order m.	€/m.<1R	€/m.≥1R
dikte/épaisseur : 130 - 280 µ								
Nacre White Gloss	1,52	25	HX30BNCB	88103231	-	1	37,57	31,94
Pearl White Gloss	1,52	25	HX30BPEB	88103229	-	1	37,57	31,94
Scarab Green/Violet Gloss	1,52	25	HX30VVS	88103257		1	37,57	31,94
Midnight Blue Matt	1,52	25	HX30BDMM	88164872		5	37,57	31,94
Neon Blue Gloss	1,52	25	HX30BNEB	88164873		1	37,57	31,94
Payne's Grey Matt	1,52	25	HX30GDPM	88164890	-	1	37,57	31,94
Imperial Yellow Gloss	1,52	25	HX30JIMB	88164891	-	1	37,57	31,94
Papaya Orange Matt	1,52	25	HX30OPAM	88164894		5	37,57	31,94
Redcurrent Red Gloss	1,52	25	HX30RGOB	88164903	-	1	37,57	31,94
Redcurrent Red Matt	1,52	25	HX30RGOM	88164904	-	5	37,57	31,94
Boston Green Gloss	1,52	25	HX30VBOB	88164920	-	1	37,57	31,94
Boston Green Matt	1,52	25	HX30VBOM	88164923	-	1	37,57	31,94
Golden Black Matt	1,52	25	HX30N71M	88225144	-	1	37,57	31,94
Rainbow White	1,52	25	HX30RW002B	88290561	New,	1	37,57	31,94
Rainbow Black	1,52	25	HX30RW889B	88290560	New,	1	37,57	31,94
Rainbow Grey	1,52	25	HX30RW990B	88290562	New,	1	37,57	31,94

### RANGE 2 : Carbon / Alligator / Leather / Brushed

Color Name			Box Label	Ref. Papyrus	Info	Min. Order m.	€/m.<1R	€/m.≥1R
dikte/épaisseur : 130 - 280 µ								
Black Carbon Gloss	1,52	25	HX30CA890B	88103249	-	1	52,97	45,02
Carbon One Gloss	1,52	25	HX30CAONEB	88290563	-	1	52,97	45,02
Pearl White Carbon Gloss	1,52	25	HX30CABPEB	88112551		1	52,97	45,02
Graphite Grey Carbon Gloss	1,52	25	HX30CAGGRB	88103242	-	1	52,97	45,02
Raven Black Carbon Gloss	1,37	25	HX30CANC0B	88164875		1	52,97	45,02
Chrome Silver Bright	1,37	25	HX30CHSBRB	88274398		1	52,97	45,02
Pitch Black Alligator	1,37	25	HX30AL890B	88103250		1	52,97	45,02
Petroleum Black Carbon Gloss	1,52	25	HX30CANPEB	88164876	-	1	52,97	45,02
Black Forged Carbon	1,52	25	HX30CAF89S	88290451	-	1	52,97	45,02
Artic White Alligator Gloss	1,37	25	HX30AL003B	88125529		1	52,97	45,02
Grain Leather Black	1,52	25	HX30PG889B	88166874	-	1	52,97	45,02
Fine Grain Leather Taupe Grey Gloss	1,52	25	HX30PGGTAB	88164925	-	5	52,97	45,02
Fine Grain Leather Brown Gloss	1,52	25	HX30PGMBRB	88164927	-	1	52,97	45,02
Brushed Alu Coal Black Gloss	1,52	25	HX30BA889B	88164866	-	1	52,97	45,02



## HEXIS SKINTAC CAST HX30000 (Vervolg - Suite)

Meerlagige gegoten vinyl voor car wrapping en decoratie van andere objecten.  
Vinyle coulé multicouche pour la personnalisation de véhicules ou d'objets.

RANGE 2 : Carbon / Alligator / Leather / Brushed (Vervolg - Suite)

Color Name			Box Label	Ref. Papyrus	Info	Min. Order m.	€/m.<1R	€/m.≥1R
dikte/épaisseur : 130 - 280 µ								
Brushed Aluminium Anthracite Grey Gloss	1,52	25	HX30BAGANB	88164867	-	1	52,97	45,02
Brushed Aluminium	1,52	25	HX30BASILB	88103240		1	52,97	45,02
Chameleon Grey Gloss	1,52	25	HX30G446B	88225145		1	52,97	45,02

## RANGE 3 : Super Chrome

Color Name			Box Label	Ref. Papyrus	Info	Min. Order m.	€/m.<1R	€/m.≥1R
dikte/épaisseur : 130 - 280 µ								
Super Chrome Silver Gloss	1,37	25	HX30SCH01B	88196731	-	1	82,85	70
Super Chrome Red Gloss	1,37	25	HX30SCH02B	88196738	-	1	82,85	70
Super Chrome Titanium Gloss	1,37	25	HX30SCH03B	88196739		1	82,85	70
Super Chrome Green Gloss	1,37	25	HX30SCH04B	88196744		5	82,85	70
Super Chrome Blue Gloss	1,37	25	HX30SCH05B	88196745	-	5	82,85	70
Super Chrome Purple Gloss	1,37	25	HX30SCH06B	88196746		5	82,85	70
Super Chrome Gold Gloss	1,37	25	HX30SCH07B	88196748	-	1	82,85	70
Super Chrome Rose Gold Gloss	1,37	25	HX30SCH12B	88290573	-	1	82,85	70
Super Chrome Orange Gloss	1,37	25	HX30SCH08B	88196750	-	1	82,85	70
Super Chrome Turquoise Gloss	1,37	25	HX30SCH09B	88196756		5	82,85	70
Super Chrome Pink Gloss	1,37	25	HX30SCH10B	88196757	-	1	82,85	70
Super Chrome Light Blue	1,37	25	HX30SCH11B	88196760		1	82,85	70

## RANGE 3 : Super Chrome Satin

Color Name			Box Label	Ref. Papyrus	Info	Min. Order m.	€/m.<1R	€/m.≥1R
dikte/épaisseur : 130 - 280 µ								
Super Chrome Silver Satin	1,37	25	HX30SCH01S	88274399	-	1	82,85	70
Super Chrome Red Satin	1,37	25	HX30SCH02S	88261919	-	1	82,85	70
Super Chrome Titanium Satin	1,37	25	HX30SCH03S	88274400		1	82,85	70
Super Chrome Green Satin	1,37	25	HX30SCH04S	88232427		1	82,85	70
Super Chrome Blue Satin	1,37	25	HX30SCH05S	88244626	-	1	82,85	70
Super Chrome Purple Satin	1,37	25	HX30SCH06S	88244627		1	82,85	70
Super Chrome Gold Satin	1,37	25	HX30SCH07S	88274401	-	1	82,85	70
Super Chrome Rose Gold Satin	1,37	25	HX30SCH12S	88290574		1	82,85	70
Super Chrome Orange Satin	1,37	25	HX30SCH08S	88274402		1	82,85	70
Super Chrome Turquoise Satin	1,37	25	HX30SCH09S	88274403		1	82,85	70
Super Chrome Pink Satin	1,37	25	HX30SCH10S	88274406		1	82,85	70



## HEXIS SKINTAC CAST HX20000

Gegoten vinyl voor car wrapping en decoratie van andere objecten.  
Vynyle coulé pour la personnalisation de véhicules ou d'objets.

Hexis Skintac Cast HX20000				
kleuren/couleurs		m.	€/m <sup>2</sup>	€/m.
RANGE 1 : Black and White	10	1,52	11,91	18,10
RANGE 2 : Gloss Colours / Matt Colours / Glitters	10	1,52	14,13	21,48

### RANGE 1 : Black and White

Color Name			Box Label	Ref. Papyrus	Info	Min. Order m.	€/m.<1R	€/m.≥1R
dikte/épaisseur : 80µ								
Lapland White Gloss	1,52	25	HX20002B	88103212	-	5	16,59	13,28
Lapland White Matt	1,52	25	HX20002M	88125530	-	5	18,1	14,48
Polar White Gloss	1,52	25	HX20001B	88316343		5	18,1	14,48
Glacier White Gloss	1,52	25	HX20003B	88125409	-	5	18,1	14,48
Glacier White Matt	1,52	25	HX20003M	88200756	-	5	18,1	14,48
Charcoals Black Gloss	1,52	25	HX20889B	88147179	-	5	18,1	14,48
Deep Black Gloss	1,52	25	HX20890B	88144037	-	5	18,1	14,48
Deep Black Matt	1,52	25	HX20NPRM	88125531	-	5	18,1	14,48

### RANGE 2 : Gloss Colours / Matt Colours / Glitters

Color Name			Box Label	Ref. Papyrus	Info	Min. Order m.	€/m.<1R	€/m.≥1R
Dikte/épaisseur : 80µ								
Deep Black Satin	1,52	25	HX20NPRS	88225133		5	18,1	14,48
Plum Violet Gloss	1,52	25	HX20008B	88165392		5	21,48	17,18
Lemon Yellow Gloss	1,52	25	HX20108B	88153366	-	5	21,48	17,18
Lemon Yellow Matt	1,52	25	HX20108M	88125533		5	21,48	17,18
Sun Yellow Gloss	1,52	25	HX20109B	88103214	-	5	21,48	17,18
Daffodil Yellow Gloss	1,52	25	HX20123B	88135061	-	5	21,48	17,18
Orange Red Gloss	1,52	25	HX20165B	88103213	-	5	21,48	17,18
Mandarin Red Matt	1,52	25	HX20165M	88125538	-	5	21,48	17,18
Ruby Red Gloss	1,52	25	HX20186B	88157403	-	5	21,48	17,18
Bright Cardinal Red	1,52	25	HX20200B	88141478	-	5	21,48	17,18
Blood Red Matt	1,52	25	HX20200M	88125539	-	5	21,48	17,18
Fuchsia Gloss	1,52	25	HX20220B	88144033	-	5	21,48	17,18
Fuchsia Matt	1,52	25	HX20220M	88125541		5	21,48	17,18
Wasabi Green Matt	1,52	25	HX20228M	88225134		5	21,48	17,18
Sapphire Blue Gloss	1,52	25	HX20280B	88145548	-	5	21,48	17,18
Night Blue Gloss	1,52	25	HX20281B	88151371	-	5	21,48	17,18
Intense Blue Gloss	1,52	25	HX20293B	88164657	-	5	21,48	17,18
Olympic Blue Gloss	1,52	25	HX20299B	88156514	-	5	21,48	17,18
Vivid Blue Gloss	1,52	25	HX20300B	88146094	-	5	21,48	17,18
Emerald Green Gloss	1,52	25	HX20348B	88152232		5	21,48	17,18
Apple Green Gloss	1,52	25	HX20369B	88144034	-	5	21,48	17,18
Kiwi Green Gloss	1,52	25	HX20375B	88163879	-	5	21,48	17,18
Light Green Matt	1,52	25	HX20375M	88125535	-	5	21,48	17,18
Dark Grey Gloss	1,52	25	HX20445B	88165395	-	5	21,48	17,18
Traffic Grey Gloss	1,52	25	HX20446B	88158388	-	5	21,48	17,18



## HEXIS SKINTAC CAST HX20000 (Vervolg - Suite)

Gegoten vinyl voor car wrapping en decoratie van andere objecten.  
Vinyle coulé pour la personnalisation de véhicules ou d'objets.

RANGE 2 : Gloss Colours / Matt Colours / Glitters (Vervolg - Suite)

Color Name			Box Label	Ref. Papyrus	Info	Min. Order m.	€/m.<1R	€/m.≥1R
dikte/épaisseur : 80µ								
Ivory Gloss	1,52	25	HX20468B	88183335	-	5	21,48	17,18
Brown Gloss	1,52	25	HX20476B	88165396	-	5	21,48	17,18
Tomato Red Gloss	1,52	25	HX20485B	88140622	-	5	21,48	17,18
Dark Navy Blue Gloss	1,52	25	HX20532B	88147526	-	5	21,48	17,18
Blue Tiffany Gloss	1,52	25	HX20BTIB	88165400	-	5	21,48	17,18
Turquoise Blue Matt	1,52	25	HX20BTUM	88125543	-	5	21,48	17,18
Taxi Beige Gloss	1,52	25	HX20BTXB	88165405	-	5	21,48	17,18
Honey yellow Gloss	1,52	25	HX20JMIB	88165407		5	21,48	17,18
Coffee Brown Gloss	1,52	25	HX20MCAB	88103205		5	21,48	17,18
Candy Pink Gloss	1,52	25	HX20PCAB	88103211		5	21,48	17,18
Military Green Matt	1,52	25	HX20VMIM	88125544	-	5	21,48	17,18
Gold Gloss	1,52	25	HX20871B	88165302	-	5	21,48	17,18
Silver Gloss	1,52	25	HX20877B	88166659	-	5	21,48	17,18
Night Blue Met Gloss	1,52	25	HX20905B	88103209	-	5	21,48	17,18
NightBlue Met Matt	1,52	25	HX20905M	88125545	-	5	21,48	17,18
Bronze Grey Met Gloss	1,52	25	HX20948B	88153195	-	5	21,48	17,18
Meteorite Grey Met Gloss	1,52	25	HX20990B	88163878	-	5	21,48	17,18
Meteorite Grey Met Matt	1,52	25	HX20990M	88125546	-	5	21,48	17,18
Ashen Beige Metallic Gloss	1,52	25	HX20BCMB	88165410	-	5	21,48	17,18
Lapp Sparkle WhiteGloss	1,52	25	HX20BLPB	88165415	-	5	21,48	17,18
Anthracite Grey Metallic Mat	1,52	25	HX20GANM	88165416	-	5	21,48	17,18
Frozen Grey Matt	1,52	25	HX20GGIM	88165421	-	5	21,48	17,18
Marrakesh Brown Gloss	1,52	25	HX20MMAB	88103204	-	5	21,48	17,18
Marrakesh Brown Matt	1,52	25	HX20MMAM	88165422	-	5	21,48	17,18
Ebony Sparkle Black Matt	1,52	25	HX20NEPM	88112533		5	21,48	17,18
Ebony Sparkle Black Gloss	1,52	25	HX20NEPB	88132337	Sparkle,	5	21,48	17,18
Fjord Blue Gloss	1,52	25	HX20BFJB	88157413	Sparkle,	5	21,48	17,18
Indian Pink Gloss	1,52	25	HX20RNIB	88165431	Sparkle,	5	21,48	17,18
Byzantine Violet Gloss	1,52	25	HX20VBYB	88165435	Sparkle,	5	21,48	17,18
Zeus Gold Gloss	1,52	25	HX20P001B	88159737	Sparkle	5	21,48	17,18
Apollo Blue Gloss	1,52	25	HX20P004B	88165425	Sparkle	5	21,48	17,18
Triton Blue Gloss	1,52	25	HX20P005B	88165427	Sparkle	5	21,48	17,18
Saturn White Gloss	1,52	25	HX20BSAB	88158851	Sparkle	5	21,48	17,18
Catechu Black Gloss	1,52	25	HX20NCAB	88136929	Sparkle	5	21,48	17,18
Aurora Orange Gloss	1,52	25	HX200AUB	88134122	Sparkle	5	21,48	17,18
Jellybean Pink Gloss	1,52	25	HX20RDRB	88140233	Sparkle	5	21,48	17,18
Garnet Red Gloss	1,52	25	HX20RGRB	88138299	Sparkle	5	21,48	17,18
Orange Urbain Gloss	1,52	25	HX20495B	88204631		5	21,48	17,18
Ara Blue Métallic Satin	1,52	25	HX20219S	88225142		5	21,48	17,18
Nacre White Satin	1,52	25	HX20BNCS	88225131	-	5	21,48	17,18
Santi Grey Satin	1,52	25	HX20G03S	88225126		5	21,48	17,18
Argenticy Grey Satin	1,52	25	HX20G04S	88225127		5	21,48	17,18
Shark Grey Gloss	1,52	25	HX20423B	88225141	-	5	21,48	17,18
Duck Blue Gloss	1,52	25	HX20315B	88225143	-	5	21,48	17,18
Acid Green Satin	1,52	25	HX20266S	88228974		5	21,48	17,18
Red Alu Satin	1,52	25	HX20196S	88228977		5	21,48	17,18
FirnamentBlueGloss	1,52	25	HX20033B	88232204		5	21,48	17,18
ElderberryPurpGloss	1,52	25	HX20352B	88232208		5	21,48	17,18
Manga Purple Gloss	1,52	25	HX20518B	88232209		5	21,48	17,18
MetallicYellowGloss	1,52	25	HX20558B	88232210		5	21,48	17,18



## HEXIS SKINTAC CAST HX20000 (Vervolg - Suite)

Gegoten vinyl voor car wrapping en decoratie van andere objecten.

Vinyle coulé pour la personnalisation de véhicules ou d'objets.

RANGE 2 : Gloss Colours / Matt Colours / Glitters (Vervolg - Suite)

Color Name			Box Label	Ref. Papyrus	Info	Min. Order m.	€/m.<1R	€/m.≥1R
dikte/épaisseur : 80µ								
Celestial Blue Met Satin	1,52	25	HX20558B	88250483		5	21,48	17,18
Metallic Purple Gloss	1,52	25	HX20528B	88250485		5	21,48	17,18
Canyon Copper Met Satin	1,52	25	HX20661S	88250486		5	21,48	17,18
Vampire Black Gloss	1,52	25	HX20N03B	88298443		5	21,48	17,18
Dust Grey Gloss	1,52	25	HX20G06B	88298448		5	21,48	17,18
Yas Marina Blue Metallic Gloss	1,52	25	HX20646B	88297035	New -	5	21,48	17,18
Aston Grey Gloss	1,52	25	HX20G07B	88297036	New -	5	21,48	17,18
Sherwood Green Gloss	1,52	25	HX20V14B	88297037	New -	5	21,48	17,18
Fluorescent Yellow Gloss	1,52	25	HX20613B	88297038	New	5	21,48	17,18



## HEXIS SMARTAC CAST KG8000

Gegoten snijfilm, superieure kwaliteit.  
Vinyl coulé très haut performance.

Hexis smartac cast KG8000				
kleuren/couleurs		m.	€/m <sup>2</sup>	€/m.
RANGE 1 : White, Black, Clear	10	1,23	6,82	8,53
RANGE 2 : Colours	10	1,23	7,70	9,63
RANGE 3 : Metallics	10	1,23	8,95	11,19

### RANGE 1 : White, Black, Clear

Color Name			Box Label	Ref. Papyrus	Info	Min. Order m.	€/m.<1R	€/m.≥1R
dikte/épaisseur : 50μ								
Clear Gloss	1,23	30	KG8899B	#		30	8,53	6,82
Lapland White Gloss	1,23	30	KG8002B	#		30	8,53	6,82
Lapland White Mat	1,23	30	KG8002M	#		30	8,53	6,82
Carbon Black Gloss	1,23	30	KG8889B	#		30	8,53	6,82
Deep Black Gloss	1,23	30	KG8890B	#		30	8,53	6,82

### RANGE 2 : Colours

Color Name			Box Label	Ref. Papyrus	Info	Min. Order m.	€/m.<1R	€/m.≥1R
dikte/épaisseur : 50μ								
Lemon Yellow Gloss	1,23	30	KG8108B	#		30	9,63	7,7
Buttercup Yellow Gloss	1,23	30	KG8109B	#		30	9,63	7,7
Klee Yellow Gloss	1,23	30	KG8115B	#		30	9,63	7,7
Daffodil Yellow Gloss	1,23	30	KG8123B	#		30	9,63	7,7
Mustard Yellow Gloss	1,23	30	KG8136B	#		30	9,63	7,7
Mango Orange Gloss	1,23	30	KG8138B	#		30	9,63	7,7
Apricot Yellow Gloss	1,23	30	KG8137B	#		30	9,63	7,7
Colocynth Orange Gloss	1,23	30	KG8164B	#		30	9,63	7,7
Orange Gloss	1,23	30	KG8165B	#		30	9,63	7,7
Clementine Reg Gloss	1,23	30	KG8166B	#		30	9,63	7,7
Fire Red Gloss	1,23	30	KG8795B	#		30	9,63	7,7
Tomato Red Gloss	1,23	30	KG8485B	#		30	9,63	7,7
Rose Red Gloss	1,23	30	KG8187B	#		30	9,63	7,7
Ruby Red Gloss	1,23	30	KG8186B	#		30	9,63	7,7
Bright Cardinal Red Gloss	1,23	30	KG8200B	#		30	9,63	7,7
Wine Red Gloss	1,23	30	KG8201B	#		30	9,63	7,7
Basque Red Gloss	1,23	30	KG8503B	#		30	9,63	7,7
Burgundy Red Gloss	1,23	30	KG8505B	#		30	9,63	7,7
Fuchsia Gloss	1,23	30	KG8220B	#		30	9,63	7,7
Gladiolas Pink Gloss	1,23	30	KG8221B	#		30	9,63	7,7
Medium Violet Gloss	1,23	30	KG8VMOB	#		30	9,63	7,7
Powder Blue Gloss	1,23	30	KG8297B	#		30	9,63	7,7
Olympic Blue Gloss	1,23	30	KG8299B	#		30	9,63	7,7
Horizon Blue Gloss	1,23	30	KG8BHOB	#		30	9,63	7,7
Intense Blue Gloss	1,23	30	KG8293B	#		30	9,63	7,7



## HEXIS SMARTAC CAST KG8000 (Vervolg - Suite)

Gegoten snijfilm, superieure kwaliteit.  
Vinyl coulé très haut performance.

### RANGE 2 : Colours (Vervolg - Suite)

Color Name			Box Label	Ref. Papyrus	Info	Min. Order m.	€/m.<1R	€/m.≥1R
dikte/épaisseur : 50µ								
Vivid Blue Gloss	1,23	30	KG8300B	#		30	9,63	7,7
Reflex Blue Gloss	1,23	30	KG8RFXB	#		30	9,63	7,7
Sapphire Blue Gloss	1,23	30	KG8280B	#		30	9,63	7,7
Light Navy Blue Gloss	1,23	30	KG8281B	#		30	9,63	7,7
Mediterranean Blue Gloss	1,23	30	KG8BMEB	#		30	9,63	7,7
Dark Navy Blue Gloss	1,23	30	KG8532B	#		30	9,63	7,7
Yellowed Green Gloss	1,23	30	KG8VJAB	#		30	9,63	7,7
Springtime Green Gloss	1,23	30	KG8VPRB	#		30	9,63	7,7
Kiwi Green Gloss	1,23	30	KG8375B	#		30	9,63	7,7
Apple Green Gloss	1,23	30	KG8369B	#		30	9,63	7,7
Parrot Green Gloss	1,23	30	KG8368B	#		30	9,63	7,7
Meadow Green Gloss	1,23	30	KG8370B	#		30	9,63	7,7
Clover Green Gloss	1,23	30	KG8354B	#		30	9,63	7,7
Emerald Green Gloss	1,23	30	KG8348B	#		30	9,63	7,7
Racing Green Gloss	1,23	30	KG8336B	#		30	9,63	7,7
Bramble Green Gloss	1,23	30	KG8302B	#		30	9,63	7,7
Madera Green Gloss	1,23	30	KG8VMDDB	#		30	9,63	7,7
Ivory Gloss KG8468B	1,23	30	KG8468B	#		30	9,63	7,7
Sahara Yellow Gloss	1,23	30	KG8JSAB	#		30	9,63	7,7
Derain Yellow Gloss	1,23	30	KG8106B	#		30	9,63	7,7
Brown Gloss	1,23	30	KG8476B	#		30	9,63	7,7
Oyster Grey Gloss	1,23	30	KG8428B	#		30	9,63	7,7
Mouse Grey Gloss	1,23	30	KG8430B	#		30	9,63	7,7
Dark Grey Gloss	1,23	30	KG8445B	#		30	9,63	7,7
Platinum Grey Gloss	1,23	30	KG8GPLB	#		30	9,63	7,7
Traffic Grey Gloss	1,23	30	KG8446B	#		30	9,63	7,7
Galactic Grey Gloss	1,23	30	KG8G02B	#		30	9,63	7,7

### RANGE 3 : Metallics

Color Name			Box Label	Ref. Papyrus	Info	Min. Order m.	€/m.<1R	€/m.≥1R
Lipari Blue Metallic Gloss	1,23	30	KG8963B	#		30	11,19	8,95
Poseidon Blue Gloss	1,23	30	KG8964B	#		30	11,19	8,95
Liqueur lue Gloss	1,23	30	KG8961B	#		30	11,19	8,95
Lapis Blue Gloss	1,23	30	KG8965B	#		30	11,19	8,95
Meteorite Grey Gloss	1,23	30	KG8990B	#		30	11,19	8,95
Smokey Grey Gloss	1,23	30	KG8GFUB	#		30	11,19	8,95
Titanium Grey Gloss	1,23	30	KG8879B	#		30	11,19	8,95
Bronze Grey Gloss	1,23	30	KG8948B	#		30	11,19	8,95
Robot Grey Metallic Gloss	1,23	30	KG8875B	#		30	11,19	8,95
Mineral Grey Metallic Gloss	1,23	30	KG8878B	#		30	11,19	8,95
Onyx Beige Metallic Gloss	1,23	30	KG8870B	#		30	11,19	8,95
Gold Gloss	1,23	30	KG8871B	#		30	11,19	8,95
Silver Gloss	1,23	30	KG8877B	#		30	11,19	8,95





## HEXIS SUPTAC POLYMERIC S5000

Gekalanderde polymeerfilm voor complexe toepassingen op vlakke en licht gebogen ondergronden.  
Vinyle calandré polymère pour des applications complexes sur des surfaces planes et légèrement courbées.

Hexis suptac polymeric S5000				
kleuren/couleurs	10,10,5	1,23 m.	€/m <sup>2</sup>	€/m.
RANGE 1 : White, Black, Clear	10,10,5	1,23	5,24	6,55
RANGE 2 : Colours	4-10	1,23	6,11	7,63
RANGE 3 : Metallics	2-8	1,23	6,51	8,14

### RANGE 1 : White, Black, Clear

Color Name			Box Label	Ref. Papyrus	Info	Min. Order m.	€/m.<1R	€/m.≥1R
dikte/épaisseur : 65µ								
White Gloss	1,23	30	S5001B	88103259	-	5	6,55	5,24
White Matt	1,23	30	S5001M	88103344	-	5	6,55	5,24
Black Gloss	1,23	30	S5889B	88103334	-	5	6,55	5,24
Black Matt	1,23	30	S5889M	88103335	-	5	6,55	5,24
Clear Gloss	1,23	30	S5899B	88103336		5	6,55	5,24

### RANGE 2 : Colours

Océan Blue Gloss	1,23	30	S5005B	88103260	-	5	7,63	6,11
Orange Red	1,23	30	S5048B	88196761		5	7,63	6,11
Lemon Gloss	1,23	30	S5108B	88103261	-	5	7,63	6,11
Pastel Buttercup Gloss	1,23	30	S5109B	88103345	-	5	7,63	6,11
Daffodil Gloss	1,23	30	S5123B	88103262	-	5	7,63	6,11
Mustard Gloss / White Adhesive	1,23	30	S5136B	88103263	-	5	7,63	6,11
Apricot Gloss	1,23	30	S5137B	88103346	-	5	7,63	6,11
Orange Gloss	1,23	30	S5165B	88103265	-	5	7,63	6,11
Salmon Pink Gloss	1,23	30	S5169B	88103267	-	5	7,63	6,11
Vermillion Gloss	1,23	30	S5179B	88103268		5	7,63	6,11
Ruby Gloss	1,23	30	S5186B	88103269	-	5	7,63	6,11
Cardinal Red Gloss	1,23	30	S5193B	88103270	-	5	7,63	6,11
Bright Cardinal Red Gloss	1,23	30	S5200B	88103271	-	5	7,63	6,11
Wine Red Gloss	1,23	30	S5201B	88103272	-	5	7,63	6,11
Clay Grey Gloss	1,23	30	S5205B	88196773		5	7,63	6,11
Magenta Gloss	1,23	30	S5214B	88103273		5	7,63	6,11
Fuchsia Gloss	1,23	30	S5220B	88103274	-	5	7,63	6,11
Lilac Gloss	1,23	30	S5251B	88103276	-	5	7,63	6,11
Dark Jade Gloss	1,23	30	S5268B	88103277	-	5	7,63	6,11
Hollyhock Gloss	1,23	30	S5278B	88103278	-	5	7,63	6,11
Sapphire Gloss	1,23	30	S5280B	88103279	-	5	7,63	6,11
Light Navy Blue Gloss	1,23	30	S5281B	88103280		5	7,63	6,11
Adriatic Blue Gloss	1,23	30	S5288B	88196767		5	7,63	6,11
Intense Blue Gloss	1,23	30	S5293B	88103281	-	5	7,63	6,11
Navy Blue Gloss	1,23	30	S5295B	88103283	-	5	7,63	6,11
Lakeview Gloss	1,23	30	S5298B	88103285	-	5	7,63	6,11
Olympic Blue Gloss	1,23	30	S5299B	88103286	-	5	7,63	6,11
Vivid Blue Gloss	1,23	30	S5300B	88103287	-	5	7,63	6,11
Onyx Blue Gloss	1,23	30	S5303B	88196765	-	5	7,63	6,11
Turquoise Gloss	1,23	30	S5320B	88103289	-	5	7,63	6,11
Forest Green Gloss	1,23	30	S5323B	88103290	-	5	7,63	6,11





## HEXIS SUPTAC POLYMERIC S5000 (Vervolg - Suite)

Gekalanderde polymeerfilm voor complexe toepassingen op vlakke en licht gebogen ondergronden.  
Vinyle calandré polymère pour des applications complexes sur des surfaces planes et légèrement courbées.

### RANGE 2 : Colours (Vervolg - Suite)

Color Name			Box Label	Ref. Papyrus	Info	Min. Order m.	€/m.<1R	€/m.≥1R
Mint Gloss	1,23	30	S5332B	88103291	🕒	5	7,63	6,11
Racing Green Gloss	1,23	30	S5336B	88103293	-	5	7,63	6,11
Emerald Gloss	1,23	30	S5348B	88103295	-	5	7,63	6,11
Pistachio Gloss	1,23	30	S5351B	88103296	-	5	7,63	6,11
Clover Green Gloss	1,23	30	S5354B	88103297	-	5	7,63	6,11
Fern Gloss	1,23	30	S5360B	88103299	-	5	7,63	6,11
Granny Green Gloss	1,23	30	S5370B	88159794	-	5	7,63	6,11
Kiwi Gloss	1,23	30	S5375B	88103302	-	5	7,63	6,11
Acacia Green	1,23	30	S5VACB	88151147	-	5	7,63	6,11
Olive Green Gloss	1,23	30	S5392B	88103303	-	5	7,63	6,11
Oyster Grey Gloss	1,23	30	S5428B	88103305	-	5	7,63	6,11
Medium Grey Gloss	1,23	30	S5431B	88103307	-	5	7,63	6,11
Dove Grey Gloss	1,23	30	S5443B	88103310	-	5	7,63	6,11
Dark Grey Gloss	1,23	30	S5445B	88103311	-	5	7,63	6,11
Traffic Grey Gloss	1,23	30	S5446B	88103312	-	5	7,63	6,11
Beige Gloss	1,23	30	S5461B	88103313	🕒	5	7,63	6,11
Ivory Gloss	1,23	30	S5468B	88103314	🕒	5	7,63	6,11
Brown Gloss	1,23	30	S5476B	88103315	-	5	7,63	6,11
Pink Violet Gloss	1,23	30	S5480B	88103316	-	5	7,63	6,11
Tomato Gloss	1,23	30	S5485B	88103317	-	5	7,63	6,11
Caper Green Gloss	1,23	30	S5498B	88103318	🕒	5	7,63	6,11
Flamingo Grey Gloss	1,23	30	S5517B	88103321	🕒	5	7,63	6,11
Purple Gloss	1,23	30	S5527B	88103322	🕒	5	7,63	6,11
Dark Navy Gloss	1,23	30	S5532B	88103323	-	5	7,63	6,11
Havana Brown Gloss	1,23	30	S5635B	88103327	🕒	5	7,63	6,11
Lavender Gloss	1,23	30	S5655B	88103328	🕒	5	7,63	6,11
Magnolia Gloss	1,23	30	S5685B	88103329	-	5	7,63	6,11
Fire Red Gloss	1,23	30	S5795B	88103331	-	5	7,63	6,11
Graphite Grey Gloss	1,23	30	S5850B	88196774	🕒	5	7,63	6,11
Ecu Gloss	1,23	30	S5B05B	88196768	-	5	7,63	6,11
Panama Beige	1,23	30	S5BPAB	88196769	-	5	7,63	6,11
Beige Grey Gloss	1,23	30	S5GBEB	88196770	-	5	7,63	6,11
Light Grey Gloss	1,23	30	S5GLCB	88196771	🕒	5	7,63	6,11
Cream Gloss	1,23	30	S5BA01B	88196772	🕒	5	7,63	6,11
Electric Blue Gloss	1,23	30	S5ELEB	88103337	🕒	5	7,63	6,11
Nordic Blue Gloss	1,23	30	S5NORB	88103339	🕒	5	7,63	6,11
Bright Orange Gloss	1,23	30	S5OVIF	88103340	🕒	5	7,63	6,11
Reflex Blue Gloss	1,23	30	S5RFXB	88103341	-	5	7,63	6,11
Powder Blue Gloss	1,23	30	S5297B	88103284	-	5	7,63	6,11
Liberty Blue Gloss	1,23	30	S5009B	88261821	🕒	5	7,63	6,11
Whale Grey Gloss	1,23	30	S5020B	88261824	🕒	5	7,63	6,11
Shadow Grey Gloss	1,23	30	S5059B	88261827	🕒	5	7,63	6,11

### RANGE 3 : Metallics

Color Name			Box Label	Ref. Papyrus	Info	Min. Order m.	€/m.<1R	€/m.≥1R
Gold Gloss	1,23	30	S5871B	88103332	-	5	8,14	6,51
Silver Gloss	1,23	30	S5877B	88103333	-	5	8,14	6,51
Charcoal Grey Gloss	1,23	30	S5433B	88103308	-	5	8,14	6,51



## HEXIS SUPTAC POLYMERIC HXS5000

Zelfde kenmerken als de Suptac S5000 serie maar met HEX'Press liner voor een nog eenvoudigere applicatie.

Mêmes caractéristiques que la gamme Suptac S5000 avec le liner HEX'Press pour encore plus de facilité de pose.

RANGE 1 : White, Black

Color Name			Box Label	Ref. Papyrus	Info	Min. Order m.	€/m <sup>2</sup>	€/
------------	--	--	-----------	--------------	------	---------------	------------------	----

dikte/épaisseur : 65µ

Polar White	1,23	30	HXS5001B			30	6,65	245,39
Polar White Matt	1,23	30	HXS5001M			30	6,65	245,39
Black	1,23	30	HXS5889B			30	6,65	245,39
Black Matt	1,23	30	HXS5889M			30	6,65	245,39

### RANGE 2 : Colours

Buttercup	1,23	30	HXS5109B			30	7,87	290,4
Orange	1,23	30	HXS5165B			30	7,87	290,4
Ruby	1,23	30	HXS5186B			30	7,87	290,4
Bright Cardinal Red	1,23	30	HXS5200B			30	7,87	290,4
Sapphire	1,23	30	HXS5280B			30	7,87	290,4
Olympic Blue	1,23	30	HXS5299B			30	7,87	290,4
Granny Green	1,23	30	HXS5370B			30	7,87	290,4
Traffic Grey	1,23	30	HXS5446B			30	7,87	290,4

### RANGE 3 : Special

Charcoal Grey	1,23	30	HXS5433B			30	8,76	323,24
Silver	1,23	30	HXS5877B			30	8,76	323,24



## HEXIS ECOTAC MONOMERIC E3000

Gekalanderde monomere printfolie voor vlakke ondergronden.

Vinyle calandré monomère intermédiaire, Surfaces planes.

Hexis Ecotac monomeric E3000				
kleuren/couleurs	5,5,1	1,23 m.	€/m <sup>2</sup> 2,91	€/m. 3,58
RANGE 1 : White, Black, Clear	5,5,1	1,23	2,91	3,58
RANGE 2 : Colours	2-5	1,23	3,17	3,90
RANGE 3 : Metallics	2	1,23	5,25	6,46

### RANGE 1 : White, Black, Clear

Color Name			Box Label	Ref. Papyrus	Info	Min. Order m.	€/m.<1R	€/m.≥1R
dikte/épaisseur : 80µ								
White Gloss	1,23	30	E3829B	88103412	-	5	3,58	2,86
White Matt	1,23	30	E3829M	88103413	-	5	3,58	2,86
Black Gloss	1,23	30	E3889B	88103416	-	5	3,58	2,86
Black Matt	1,23	30	E3889M	88103417	-	5	3,58	2,86

### RANGE 2 : Colours

Color Name			Box Label	Ref. Papyrus	Info	Min. Order m.	€/m.<1R	€/m.≥1R
Intense Yellow Gloss	1,23	30	E3110B	88159788		5	3,9	3,12
Intense Yellow Matt	1,23	30	E3110M	88159793		5	3,9	3,12
Bright Yellow Gloss	1,23	30	E3116B	88159792		5	3,9	3,12
Bright Yellow Matt	1,23	30	E3116M	88159789		5	3,9	3,12
Gold Yellow Gloss	1,23	30	E3123B	88103353		5	3,9	3,12
Gold Yellow Matt	1,23	30	E3123M	88103354	-	5	3,9	3,12
Orange Gloss	1,23	30	E3151B	88103355	-	5	3,9	3,12
Orange Matt	1,23	30	E3151M	88103356		5	3,9	3,12
Sunrise Gloss	1,23	30	E3179B	88103358		5	3,9	3,12
Sunrise Matt	1,23	30	E3179M	88103359		5	3,9	3,12
Lipstick Gloss	1,23	30	E3186B	88103360		5	3,9	3,12
Lipstick Matt	1,23	30	E3186M	88103361	-	5	3,9	3,12
Sapphire Gloss	1,23	30	E3280B	88103364		5	3,9	3,12
Sapphire Matt	1,23	30	E3280M	88103365		5	3,9	3,12
Dark Blue Gloss	1,23	30	E3281B	88103366		5	3,9	3,12
Dark Blue Matt	1,23	30	E3281M	88103367		5	3,9	3,12
Mediterranean Blue Gloss	1,23	30	E3286B	88103368		5	3,9	3,12
Mediterranean Blue Matt	1,23	30	E3286M	88103369		5	3,9	3,12
Traffic Blue Gloss	1,23	30	E3293B	88103370		5	3,9	3,12
Traffic Blue Matt	1,23	30	E3293M	88103371		5	3,9	3,12
Perm, Blue Gloss	1,23	30	E3294B	88103372		5	3,9	3,12
Perm, Blue Matt	1,23	30	E3294M	88103373		5	3,9	3,12
Ice Blue Gloss	1,23	30	E3279B	88200778		5	3,9	3,12
Ice Blue Matt	1,23	30	E3279M	88103375		5	3,9	3,12
Olympic Blue Matt	1,23	30	E3298M	88103377		5	3,9	3,12
Cont, Blue Gloss	1,23	30	E3300B	88103378		5	3,9	3,12
Cont, Blue Matt	1,23	30	E3300M	88103379		5	3,9	3,12



## HEXIS ECOTAC MONOMERIC E3000 (Vervolg - Suite)

Gekalanderde monomere printfolie voor vlakke ondergronden.  
Vinyle calandré monomère intermédiaire, Surfaces planes.

### RANGE 2 : Colours (Vervolg - Suite)

Color Name			Box Label	Ref. Papyrus	Info	Min. Order m.	€/m.<1R	€/m.≥1R
Turquoise Gloss	1,23	30	E3320B	88103380	-	5	3,9	3,12
Turquoise Matt	1,23	30	E3320M	88103381		5	3,9	3,12
Racing Green Gloss	1,23	30	E3336B	88103382		5	3,9	3,12
Kelly Green Gloss	1,23	30	E3340B	88103384		5	3,9	3,12
Kelly Green Matt	1,23	30	E3340M	88103385		5	3,9	3,12
Emerald Green Gloss	1,23	30	E3348B	88103386		5	3,9	3,12
Emerald Green Matt	1,23	30	E3348M	88103387		5	3,9	3,12
Bottle Green Gloss	1,23	30	E3357B	88103390		5	3,9	3,12
Apple Green Gloss	1,23	30	E3361B	88159790		5	3,9	3,12
Apple Green Matt	1,23	30	E3361M	88159791		5	3,9	3,12
Bright Green Gloss	1,23	30	E3362B	88200779		5	3,9	3,12
Bright Green Matt	1,23	30	E3362M	88103395		5	3,9	3,12
Lime Green Gloss	1,23	30	E3376B	88103396		5	3,9	3,12
Lime Green Matt	1,23	30	E3376M	88103397		5	3,9	3,12
Grey Gloss	1,23	30	E3430B	88103398		5	3,9	3,12
Grey Matt	1,23	30	E3430M	88103399		5	3,9	3,12
Dark Grey Gloss	1,23	30	E3444B	88103400		5	3,9	3,12
Dark Grey Matt	1,23	30	E3444M	88103401		5	3,9	3,12
Brown Matt	1,23	30	E3476M	88103405		5	3,9	3,12
Fire Red Gloss	1,23	30	E3485B	88103406		5	3,9	3,12
Fire Red Matt	1,23	30	E3485M	88103407		5	3,9	3,12
Burgundy Gloss	1,23	30	E3505B	88103408		5	3,9	3,12
Burgundy Matt	1,23	30	E3505M	88103409	-	5	3,9	3,12
Purple Gloss	1,23	30	E3527B	88103410		5	3,9	3,12
Purple Matt	1,23	30	E3527M	88103411		5	3,9	3,12
Electric Blue Gloss	1,23	30	E3ELEB	88103418		5	3,9	3,12
Electric Blue Matt	1,23	30	E3ELEM	88103419		5	3,9	3,12
Process Blue Gloss	1,23	30	E3PROB	88103420		5	3,9	3,12
Process Blue Matt	1,23	30	E3PROM	88103421		5	3,9	3,12
Peacock Blue Gloss	1,23	30	E3307B	88261926		5	3,9	3,12

### RANGE 3 : Metallics

Gold Gloss	1,23	30	E3871B	88103414	-	5	6,46	5,17
Silver Gloss	1,23	30	E3877B	88103415	-	5	6,46	5,17

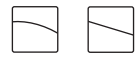

## HEXIS ECOTAC MONOMERIC High Tack - VCRE 3800

Vinyl specifiek aanbevolen voor binnentoepassingen op wanden (type Placoplatre® BA13, Gyproc, gladde of licht gestructureerde wanden) of voor toepassing op substraten met lage oppervlaktespanning (o.a. polyethyleen, polypropyleen type afvalcontainer).

Matte finish. Vinyle particulièrement recommandé pour une application intérieure sur parois (type Placoplatre® BA13, Gyproc, murs lisses ou légèrement structurés) ou pour une application sur des surfaces à faible énergie (polyéthylène, polypropylène type container poubelle). Aspect mat

RANGE 1 : White, Black

Color Name			Box Label	Ref. Papyrus	Info	Min. Order m.	€/m.<1R	€/m.≥1R
dikte/épaisseur : 80µ								
High Tack White mat	1,23	30	VCRE3829M	88112584	-	30	5,61	4,49
High Tack Black mat	1,23	30	VCRE3889M	88112583	-	30	5,61	4,49

## RANGE 2 : Colours

Color Name			Box Label	Ref. Papyrus	Info	Min. Order m.	€/m.<1R	€/m.≥1R
High Tack Light Yellow mat	1,23	30	VCRE3116M	88306732		30	6,72	5,38
High Tack Ruby Red mat	1,23	30	VCRE3186M	88112585		30	6,72	5,38
High Tack Pacific Blue mat	1,23	30	VCRE3280M	88112587		30	6,72	5,38
High Tack Medium Green mat	1,23	30	VCRE3340M	88112586		30	6,72	5,38
High Tack Dark Grey mat	1,23	30	VCRE3444M			30	6,72	5,38
High Tack Burgundy mat	1,23	30	VCRE3505M			30	6,72	5,38

## WINDOW FILMS - HEXIS ETCHED GLASS

PVC films geschikt voor in- en outdoor gebruik, Ideaal voor originele applicaties op glas (kantoor, winkels, banken, horeca...). De semi-translucent etched glass finish beschermd tegen ongewenste inkijk en geeft een esthetische toets aan glaspartijen zonder verlies aan lichtinval.

Ces PVC conviennent parfaitement aux utilisations extérieures et intérieures, Idéaux pour des applications originales sur verre (bureaux, vitrines, banques, cabinets médicaux, restaurants, bars, boutiques...). les dépolis protègent des regards indiscrets et confèrent aux espaces vitrés un caractère esthétique sans réduire la luminosité.

### HEXIS CAST ETCHED GLASS

Color Name			Box Label	Ref. Papyrus	Info	Min. Order m.	€/m.<1R	€/m.≥1R
Gegoten film met gezandstraald effect voor applicaties op glas - Vinyle effet verre dépoli coulé pour décoration sur verre, dikte/épaisseur : 80µ								
Cast Etched Glass	1,23	30	KG15DEPM			30	16,61	13,29

### HEXIS HEX'PRESS POLYMERIC ETCHED GLASS

Polymeer film met gezandstraald effect voor applicaties op glas - Vinyle effet verre dépoli polymère pour décoration sur verre, Dikte/épaisseur : 80µ

Hex'press Polymeric Etched Glass	1,23	30	HX5DEPM	88103428	-	5	13,09	10,47
----------------------------------	------	----	---------	----------	---	---	-------	-------

### HEXIS POLYMERIC ETCHED GLASS

Polymeer film met gezandstraald effect voor applicaties op glas. Vinyle effet verre dépoli polymère pour décoration sur verre. Dikte/épaisseur : 80µ

Polymeric Etched Glass	1	30	S5DEPM	88103429	-	5	8,09	6,47
Polymeric Etched Glass	1,23	30	S5DEPM	88103430	-	5	9,95	7,96
Polymeric Etched Glass	1,52	30	S5DEPM	88103431	-	5	12,29	9,84

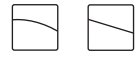

## WINDOW FILMS - HEXIS ETCHED GLASS (Vervolg - Suite)

### HEXIS CRISTAL C4000 TRANSPARENT

Gekleurde transparant glanzende polymere vinyl, Voor decoratie op glas en vitrines aangewezen - Vinyl calendré polymérique Transparent - Décoration sur Vitre jusque 3 ans de Durabilité, Dikte/épaisseur : 80µ

Grey	1,23	30	C4080	88103436	-	5	8,55	6,84
Primrose	1,23	30	C4168	88103437	-	5	8,55	6,84
Saffrin	1,23	30	C4210	88103439	-	5	8,55	6,84
Amber	1,23	30	C4232	88103440	-	5	8,55	6,84
Red	1,23	30	C4249	88103441	-	5	8,55	6,84
Raspberry Red	1,23	30	C4281	88103442	-	5	8,55	6,84
Purple	1,23	30	C4282	88103443	-	5	8,55	6,84
Permanent Red	1,23	30	C4288	88103444	-	5	8,55	6,84
Steel Blue	1,23	30	C4354	88103445	-	5	8,55	6,84
Dark Blue	1,23	30	C4387	88103446	-	5	8,55	6,84
Pale Blue	1,23	30	C4398	88103447	-	5	8,55	6,84
Lichen Green	1,23	30	C4429	88103450	-	5	8,55	6,84
Moss Green	1,23	30	C4433	88103452	-	5	8,55	6,84
Light Grey	1,23	30	C4497	88103453	-	5	8,55	6,84

## TRANSLUCENT FILMS

Gekleurde translucent polymeer gekalanderde film voor markering op lichtboxen. Vinyle calandré polymère translucide coloré, Marquage des caissons lumineux.

### HEXIS T5000 TRANSLUCENT - Colours

Color Name			Box Label	Ref. Papyrus	Info	Min. Order m.	€/m.<1R	€/m.≥1R
------------	--	--	-----------	--------------	------	---------------	---------	---------

Duurzaamheid tot 5 jaar, Jusque 5 ans de Durabilité, Dikte/épaisseur : 80µ

Primrose	1,23	30	T5015	88112588	-	5	7,37	5,89
Buttercup	1,23	30	T5116	88112589	-	5	7,37	5,89
Poppy Red	1,23	30	T5033	88112592		5	7,37	5,89
Cherry	1,23	30	T5053	88112591		5	7,37	5,89
Tomato	1,23	30	T5186	88103454	-	5	7,37	5,89
Freesia	1,23	30	T5227	88112594	-	5	7,37	5,89
Ocean Blue	1,23	30	T5274	88112595		5	7,37	5,89
China Blue	1,23	30	T5288	88112597	-	5	7,37	5,89
Adria	1,23	30	T5127	88112598	-	5	7,37	5,89
Aegean Blue	1,23	30	T5167	88112599		5	7,37	5,89
Caribbean Blue	1,23	30	T5246	88112600	-	5	7,37	5,89
Prairie	1,23	30	T5355	88112601		5	7,37	5,89
Manzana	1,23	30	T5369	88112603		5	7,37	5,89
Brown	1,23	30	T5476	88112604		5	7,37	5,89
Elephant Grey	1,23	30	T5549	88112605		5	7,37	5,89
Polar White	1,23	30	T5001	88112607		5	7,37	5,89

### HEXIS TRANSLUCENT - Block Out

Color Name			Box Label	Ref. Papyrus	Info	Min. Order m.	€/m.<1R	€/m.≥1R
------------	--	--	-----------	--------------	------	---------------	---------	---------

Block-out white	1,23	30	BOBLANC	88112608	-	5	11,21	8,97
Block-out black	1,23	30	BONNOIR	88103519	-	5	12,21	9,77

## REFLECTIVE FILMS

Decorative reflective marking films (niet voor gebruik in verkeer); voor vlakke toepassingen.  
Films rétro réfléchissants de décoration/signalétiques (non routier), Surface planes.

### HEXIS R3000 REFLECTIVE FILMS

Color Name			Box Label	Ref. Papyrus	Info	Min. Order m.	€/m <sup>2</sup>	€/roll
Dikte/épaisseur : 100µ								
White	1,23	30	R3511			30	18,15	669,74
Yellow	1,23	30	R3541			30	18,15	669,74
Orange	1,23	30	R3551			30	18,15	669,74
Red	1,23	30	R3561			30	18,15	669,74
Blue	1,23	30	R3581			30	18,15	669,74

## SPECIALTY FILMS

### HEXIS FLUO F610

Color Name			Box Label	Ref. Papyrus	Info	Min. Order m.	€/m. <sup>&lt;1R</sup>	€/m. <sup>≥1R</sup>
<b>Fluorescent promotioneel vinyl. Vlakke ondergrond.</b> <b>Vinyl promotionnel fluorescent. Surfaces planes.</b> dikte/épaisseur : 80µ								
Fluo Green	1,23	30	F612	88103462	-	5	14,72	11,77
Fluo Yellow	1,23	30	F613	88103463	-	5	14,72	11,77
Fluo Orange	1,23	30	F614	88103464	-	5	14,72	11,77
Fluo Red	1,23	30	F615	88103465	-	5	14,72	11,77
Fluo Magenta	1,23	30	F616	88103466	-	5	14,72	11,77

### HEXIS METALLIC POLYESTER P6000

Decoratieve metallic polyester film voor vlakke ondergrond. Films de décoration effets métallisés, Surfaces planes.

Dikte/épaisseur : 50µ

Brushed Silver Gloss	1,23	30	P6870	88103467		5	14,8	11,84
Silver Gloss	1,23	30	P6877	88103469	-	5	13,17	10,54
Gold Gloss	1,23	30	P6871	88103468	-	5	14,17	11,34
Rose Gold Gloss	1,23	30	P6872B	88290576	-	5	13,04	10,43

### HEXIS BLACKBOARD

Zelfklevende immitatie krijtbord Vinyle immitation tableau noir

Blackboard	1,23	30	BBNOIR	88103518	-	5	8,78	7,03
------------	------	----	--------	----------	---	---	------	------

### HEXIS WHITEBOARD - LONG TERM ERASABLE FILM

Color Name			Box Label	Ref. Papyrus	Info	Min. Order m.	€/m <sup>2</sup>	€/roll
<b>Alle opschriften met een BIC Velleda® pen kunnen eenvoudig verwijderd worden tot verscheidene maanden na opschrift.</b> <b>Ces effaçables à sec présentent l'avantage de s'effacer même après plusieurs mois d'écriture, ceci avec n'importe quel marqueur de la marque Bic Velleda®.</b>								
White Board, White	1,37	10	DWP001B	88144038	-	10	9,56	130,95
White Board, White	1,37	30	DWP001B	88144039	-	30	9,56	392,85
White Board, Clear Laminate	1,37	10	DWP002B	88103524	-	10	9,56	130,95
White Board, Clear Laminate	1,37	30	DWP002B	88144040	-	30	9,56	392,85



## SPECIALTY FILMS (Vervolg - Suite)

### HEXIS MAGNETIC FILM

Belettering of print word op de magneetfilm aangebracht. Uitsluitend geschikt om manueel te versnijden, niet voor cutting plotters. S'utilise avec du lettrage ou une impression numérique collée dessus. Découpe au cutter uniquement, pas de découpe au plotter.

Magnetic film	0,62	15	MB810	88103523	-	15	16,82	156,43
Magnetic film	1	10	MB810	88112644	-	10	19,82	198,17

### HEXIS MASKING FILM

M1000 : sandblasting granite, marble, glass / Sablage du granit,marbre, verre

M1000	1,23	25	M1000	88157750	-	25	7,29	224,24
-------	------	----	-------	----------	---	----	------	--------

Stencil : Paintmask on smooth surfaces (glass, sheet metal, floors etc,)

Réalisation de marquage sur surfaces lisses (vitres, tôles, bâches, sol etc)

Stencil	1,23	30	Stencil	88157122	-	30	3,74	137,97
Stencil	1,52	30	Stencil			30	3,74	170,54



### Hexis Truck Banner Film

Color Name			Box Label	Ref. Papyrus	Info	Min. Order m.	€/m.<1R	€/m.≥1R
------------	--	--	-----------	--------------	------	---------------	---------	---------

Duurzaamheid tot 5 jaar. Jusque 5 ans de Durabilité.

Dikte/épaisseur : 80µ

Klee Yellow 1,230m	1,23	30	TB9115S	88316325	NEW,	5	19,13	15,3
Mandarin Red 1,230m	1,23	30	TB9165S	88316326	NEW,	5	19,13	15,3
Gladiolus Pink 1,230m	1,23	30	TB9221S	88316327	NEW,	5	19,13	15,3
Sapphire Blue 1,230m	1,23	30	TB9300S	88316328	NEW,	5	19,13	15,3
Apple Green 1,230m	1,23	30	TB9369S	88316330	NEW,	5	19,13	15,3
Glacier White 1,230m	1,23	30	TB90003S	88316331	NEW,	5	19,13	15,3
Pyrite Gold 1,230m	1,23	30	TB9873S	88316332	4 jaar /4 ans,	5	19,13	15,3
Daffodil Yellow 1,230m	1,23	30	TB9123S	88316333	NEW,	5	19,13	15,3
Ruby Red 1,230m	1,23	30	TB9186S	88316334	NEW,	5	19,13	15,3
Medit. Blue 1,230m	1,23	30	TB9BMES	88316335	NEW,	5	19,13	15,3
Montpellier Blue 1,230m	1,23	30	TB9299S	88316336	NEW,	5	19,13	15,3
Coal Black 1,230m	1,23	30	TB9889S	88316338	NEW,	5	19,13	15,3
Meteorite Grey 1,230m	1,23	30	TB9990S	88316340	4 jaar /4 ans,	5	19,13	15,3



## APPLICATION TAPES

### HEXIS PAPER APPLICATION TAPE

Paper 110µ High Tack	1,22	100	HEX900			100	1	121,89
Paper 110µ Hight Tack Hexis branded	1,22	100	HEX900i	88103562	-	100	1	121,89
Paper 110µ Low Tack	1,22	100	HEX901	88103563	-	100	0,94	114,35
Paper 105µ medium tack Hexis branded	1,22	100	HEX902i	88103564	-	100	1	121,89
Paper 105µ medium tack Hexis branded	1,52	100	HEX902i	88103565	-	100	1	151,86
High perf 140µ hight tack Hexis branded	1,22	100	HEX100i	88112641	-	100	1,37	167,13

### HEXIS FILM APPLICATION TAPE

Color Name			Box Label	Ref. Papyrus	Info	Min. Order m.	€/m <sup>2</sup>	€/
------------	--	--	-----------	--------------	------	---------------	------------------	----

Polyethylene 150µ high tack	1,22	100	HEX904	88103567	-	100	0,96	116,86
Polypropylene 120µ medium tack	1,22	100	HEX910	88103569	-	100	1,45	177,18
Embossed polypropylene 90µ high tack	1,22	100	HEX915	88112640		100	1,17	143,25



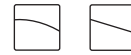

## PROTECTIVE and SAFETYFILMS

### AUTOMOTIVE SOLAR FILMS (WINDOWS) - FILMS SOLAIRES AUTOMOBILE (FENETRES)

Color Name			Box Label	Ref. Papyrus	Info	Min. Order m.	€/m <sup>2</sup>	€/roll
Automotive Solar Film	1,523	30,5	AUTO05CH	88103738		30,5	10,97	509,55
Automotive Solar Film	1,523	30,5	AUTO15CH	88103739		30,5	7,98	370,80
Automotive Solar Film	1,523	30,5	AUTO20CH	88103740		30,5	7,98	370,80
Automotive Solar Film	1,523	30,5	AUTO30CH	88103741		30,5	7,98	370,80
Automotive Solar Film	1,523	30,5	AUTO35CH	88103742		30,5	7,98	370,80

### AUTOMOTIVE PROTECTIVE FILMS - FILMS DE PROTECTION AUTOMOBILE (CARROSSERIE)

Transparante beschermfolie met zelf herstellende, zelf reinigende en anti kras eigenschappen.

Film de protection transparent long terme, auto-cicatrisantes et auto-nettoyantes ainsi que résistant aux chocs et aux rayures.

BodyFence protection film - Gloss	1,52	20	BODYFENCE	88160538	-	20	40,88	1242,78
BodyFence protection film - Mat	1,52	20	BODYFENCEM88209348		-	20	42,93	1305,08

### BUILDING SOLAR FILMS (WINDOWS) - FILMS SOLAIRES BATIMENT (FENETRES)

Color Name			Box Label	Ref. Papyrus	Info	Min. Order m.	€/m <sup>2</sup>	€/roll
------------	--	--	-----------	--------------	------	---------------	------------------	--------

Zilverkleurige, reflecterende film met spiegel effect langs buitenzijde met perfecte doorkijk langs de binnenzijde.

Films Argent - aspect réfléchissant - reflet miroir argent de l'extérieur et vue parfaite de l'intérieur.

Indoor silver safety film	1,523	15	BSOR20i2			15	5,75	131,31
Indoor silver safety film	1,523	30,5	BSOR20i2			30,5	5,75	266,98

Neutrale film met getint niet reflecterend effect langs buitenzijde met perfecte doorkijk langs de binnenzijde.

Films Neutre - aspect teinté peu réfléchissant de l'extérieur et vue parfaite de l'intérieur.

Indoor neutral safety film	1,523	15	BSON50i2			15	11,28	257,65
Indoor neutral safety film	1,523	30,5	BSON50i2			30,5	11,28	523,9

Deze films bemoeilijken een eventuele inbraak langs een raam, Indien het glas gebroken word, worden de glasfragmenten door de film samen gehouden.

Ces films permettent d'augmenter le temps d'effraction dans le cadre d'une tentative d'intrusion, Lors d'un bris de glace, ils retiennent les éclats de verre et évitent ainsi les blessures.

Indoor safety film	1,523	15	BSE50i			15	7,88	180
Indoor safety film	1,523	30,5	BSE50i			30,5	7,88	366,01



## HEXIS PURE ZONE ANTIMICROBIAL FILM

### Antimicrobial laminate



Polymere transparante gegoten film die permanente antimicrobiële stoffen bevat welke een optimale bescherming geven tegen verspreiding van bacteriën. Meer info verkrijgbaar op aanvraag.

Film polymère coulé transparent contenant des agents antimicrobiens bactériostatiques, protection intégrée pour lutter contre les microbes et bactéries. Plus d'info disponible sur demande.

Color Name			Box Label	Ref. Papyrus	Info	Min. Order m.	€/m <sup>2</sup>	€/
<b>Antimicrobial laminate</b>								
Antimicrobial laminate gloss 60μ	1,37	10	PURZON060B			10	13,62	186,54
Antimicrobial laminate gloss 60μ	1,37	30	PURZON060B			30	13,62	559,64
Antimicrobial laminate PVC free gloss 80μ1,52		30	PCWOOD01		Wood aspect -	30	17,36	791,41
Antimicrobial laminate gloss 120μ	1,52	30	PCAMPGB		Leather aspect -	30	17,36	791,41

# Papyrus Viscom

Prijslijst / Liste de prix  
R-Tape



**PAPYRUS** 

Your partner in Visual Communication

# Sign Media R-Tape

## R-TAPE APPLICATION TAPE

R-TAPE Conform™ Standard Paper Application Tape Series - 100µ	Gamme de Papier d'Application	63
Standard R-TAPE Conform™ - 100µ		63
4000 RLA - Conform™		63
4050 RLA - Conform™		63
4075 RLA - Conform™		63
R-TAPE Conform™ Premium Paper Application Tape Series - 130µ	Gamme de Papier d'Application	63
Premium R-TAPE Conform™ - 130µ		63
4700 RLA - Conform™		63
4750 RLA - Conform™		63
4760 RLA - Conform™		63
4775 RLA - Conform™		63
4776 RLA - Conform™		63
R-TAPE Clear Choice™ Filmic Application Tape Series		64
Gamme de Film d'Application Clear Choice™ R-TAPE		64
AT60n - Clear Choice™		64
AT65 - Clear Choice™		64
AT75,1 - Clear Choice™		64

## R-TAPE HotMask

Medium Tack - Medium Tack		64
R-Tape Hotmask MedTack HM350 0,5 x 25m		64
High Tack - High Tack		64
R-Tape Hotmask HighTack HM375 0,5 x 25m		64



## R-TAPE VinylEfx - Metalized Vinyl

Indoor Decorative		65
Gamme décorative intérieure		65
Smooth Silver - 65µ		65
Fine Brush Silver - 65µ		65
Smooth Gold - 65µ		65
Smooth Rose Gold - 65µ		65
Smooth Champagne - 65µ		65
Smooth Satin Copper - 65µ		65
Smooth Bronze - 65µ		65
Outdoor Decorative - 3 y, - Gamme décorative Extérieure - 3 ans		66
Smooth Silver - 65µ		66
Fine Brush Silver - 65µ		66
Smooth Gold - 65µ		66
Smooth Rose Gold - 65µ		66
Smooth Champagne - 65µ		66
Smooth Satin Copper - 65µ		66
Smooth Bronze - 65µ		66

## R-TAPE APPLICATION TAPE

Zeer stabiel en vlakliggend applicatiepapier en films.

Papier et film d'application très stable et de bonne planéité.

Color Name			Box Label	Ref. Papyrus	Info	Min. Order m.	€/m.	€/m <sup>2</sup>
------------	---	---	-----------	--------------	------	---------------	------	------------------

### R-TAPE Conform™ Standard Paper Application Tape Series

100µ Gamme de Papier d'Application Standard R-TAPE Conform™ - 100µ





#### 4000 RLA - Conform™

Low tack standard paper	1,22	100	4000 RLA	88105521		100	132,17	1,08
Low tack standard paper	1,52	100	4000 RLA	88116036		100	164,67	1,08

#### 4050 RLA - Conform™

Medium tack standard paper	0,61	100	4050 RLA	88100966	2 rolls/case	100	136,23	1,12
Medium tack standard paper	1	100	4050 RLA	88105524		100	108,33	1,08
Medium tack standard paper	1,22	100	4050 RLA	88105525		100	132,17	1,08
Medium tack standard paper	1,37	100	4050 RLA	88248487		100	148,42	1,08
Medium tack standard paper	1,52	100	4050 RLA	88105519		100	164,67	1,08

#### 4075 RLA - Conform™

High tack standard paper	0,61	100	4075 RLA		 2 rolls/case	100	136,23	1,12
High tack standard paper	1	100	4075 RLA	88105520		100	108,33	1,08
High tack standard paper	1,22	100	4075 RLA	88105527		100	132,17	1,08
High tack standard paper	1,37	100	4075 RLA	88248491		100	148,42	1,08
High tack standard paper	1,52	100	4075 RLA			100	164,67	1,08

### R-TAPE Conform™ Premium Paper Application Tape Series

130µ Gamme de Papier d'Application Premium R-TAPE Conform™ - 130µ





#### 4700 RLA - Conform™

Low tack premium paper	1,22	100	4700 RLA			100	187,07	1,53
------------------------	------	-----	----------	--	---	-----	--------	------

#### 4750 RLA - Conform™

Medium tack premium paper	1,22	100	4750 RLA	88105518		100	187,07	1,53
---------------------------	------	-----	----------	----------	--	-----	--------	------

#### 4760 RLA - Conform™

Medium high tack premium paper	1,22	100	4760 RLA			100	187,07	1,53
Medium high tack premium paper	1,37	100	4760 RLA	88168243		100	210,07	1,53

#### 4775 RLA - Conform™

High tack premium paper	1,22	100	4775 RLA	88105516		100	188,23	1,54
-------------------------	------	-----	----------	----------	--	-----	--------	------



#### 4776 RLA - Conform™

Slightly higher tack premium paper	1,22	100	4776 RLA			100	187,07	1,53
------------------------------------	------	-----	----------	--	--	-----	--------	------

## R-TAPE APPLICATION TAPE (Vervolg - Suite)

Zeer stabiel en vlakliggend applicatiepapier en films.

Papier et film d'application très stable et de bonne planéité.

Color Name			Box Label	Ref. Papyrus	Info	Min. Order m.	€/m.	€/m <sup>2</sup>
------------	---	---	-----------	--------------	------	---------------	------	------------------

### R-TAPE Clear Choice™ Filmic Application Tape Series Gamme de Film d'Application Clear Choice™ R-TAPE



#### AT60n - Clear Choice™

Medium tack film	1	100	AT60n			100	94,55	0,95
Medium tack film	1,22	100	AT60n	88167308		100	113,09	0,93
Medium tack film	1,37	100	AT60n			100	127,04	0,93

#### AT65 - Clear Choice™



High tack film	1,22	100	AT65	88166200		100	113,13	0,93
High tack film	1,52	100	AT65			100	140,95	0,93

#### AT75,1 - Clear Choice™

High tack embossed PE film	1,22	100	AT75,1	88105522		100	122	1
----------------------------	------	-----	--------	----------	--	-----	-----	---

## R-TAPE HotMask

Polyester transfer tape for heat pressing. - Tape de transfert polyester pour transfert à chaud.

Color Name			Box Label	Ref. Papyrus	Info	Min. Order m.	€/m.	€/m <sup>2</sup>
------------	---	---	-----------	--------------	------	---------------	------	------------------

#### Medium Tack - Medium Tack

##### R-Tape Hotmask MedTack HM350 0,5 x 25m

Medium tack film	0,5	25	HM350	88206298		25	42,65	3,41
------------------	-----	----	-------	----------	--	----	-------	------

#### High Tack - High Tack



##### R-Tape Hotmask HighTack HM375 0,5 x 25m

High tack film	0,5	25	HM375	88206302		25	42,65	3,41
----------------	-----	----	-------	----------	--	----	-------	------

## R-TAPE VinylEfx - Metalized Vinyl

Efx Metallic Vinyls trekken de aandacht! Indoor gebruik voor decoratie van verkooppunten en outdoor op voertuigen of boten.

Les Vinyls métalisés Efx attirent l'attention! Utilisation en intérieur pour décoration de points de vente et utilisation en extérieur sur véhicules ou bateaux.

Color Name			Box Label	Ref. Papyrus	Info	Min. Order m.	€/m.	€/m <sup>2</sup>
------------	---	---	-----------	--------------	------	---------------	------	------------------

### Indoor Decorative - Gamme décorative intérieure













Smooth Silver - 65μ								
	0,61	45,7	S3101	88203811		45,7	215,36	7,73
	1,22	45,7	S3101	88285860		45,7	430,73	7,73
	1,37	45,7	S3101			45,7	483,69	7,73
Fine Brush Silver - 65μ								
	0,61	45,7	S6501			45,7	246,58	8,85
	1,22	45,7	S6501			45,7	493,16	8,85
	1,37	45,7	S6501			45,7	553,8	8,85
Smooth Gold - 65μ								
	0,61	45,7	S3102			45,7	246,58	8,85
	1,22	45,7	S3102	88285862		45,7	493,16	8,85
	1,37	45,7	S3102			45,7	553,8	8,85
Smooth Rose Gold - 65μ								
	0,61	45,7	S3162			45,7	246,58	8,85
	1,22	45,7	S3162	88285864		45,7	493,16	8,85
Smooth Champagne - 65μ								
	0,61	45,7	S3163			45,7	246,58	8,85
	1,22	45,7	S3163	88285865		45,7	493,16	8,85
Smooth Satin Copper - 65μ								
	0,61	45,7	S3161			45,7	246,58	8,85
	1,22	45,7	S3161	88285866		45,7	493,16	8,85
Smooth Bronze - 65μ								
	0,61	45,7	S3164			45,7	246,58	8,85
	1,22	45,7	S3164	88285868		45,7	493,16	8,85

## R-TAPE VinylEfx - Metalized Vinyl (Vervolg - Suite)

Efx Metallic Vinyls trekken de aandacht! Indoor gebruik voor decoratie van verkooppunten en outdoor op voertuigen of boten.

Les Vinyls métalisés Efx attirent l'attention! Utilisation en intérieur pour décoration de points de vente et utilisation en extérieur sur véhicules ou bateaux.

Color Name			Box Label	Ref. Papyrus	Info	Min. Order m.	€/m.	€/m <sup>2</sup>
<b>Outdoor Decorative - 3 y, - Gamme décorative Extérieure - 3 ans</b>								
								
<b>Smooth Silver - 65µ</b>								
	0,61	45,7	E3101	88105533		45,7	417,95	14,99
	1,22	45,7	E3101	88285876		45,7	835,91	14,99
<b>Fine Brush Silver - 65µ</b>								
	0,61	45,7	E6501			45,7	478,62	17,17
	1,22	45,7	E6501			45,7	957,25	17,17
<b>Smooth Gold - 65µ</b>								
	0,61	45,7	E3102			45,7	478,62	17,17
	1,22	45,7	E3102	88285879		45,7	957,25	17,17
<b>Smooth Rose Gold - 65µ</b>								
	0,61	45,7	E3162			45,7	478,62	17,17
	1,22	45,7	E3162	88285884		45,7	957,25	17,17
<b>Smooth Champagne - 65µ</b>								
	0,61	45,7	E3163			45,7	478,62	17,17
	1,22	45,7	E3163	88285886		45,7	957,25	17,17
<b>Smooth Satin Copper - 65µ</b>								
	0,61	45,7	E3161			45,7	478,62	17,17
	1,22	45,7	E3161	88285888		45,7	957,25	17,17
<b>Smooth Bronze - 65µ</b>								
	0,61	45,7	E3164			45,7	478,62	17,17
	1,22	45,7	E3164	88285893		45,7	957,25	17,17



# Papyrus Viscom

Prijslijst / Liste de prix  
Sign Media 3M

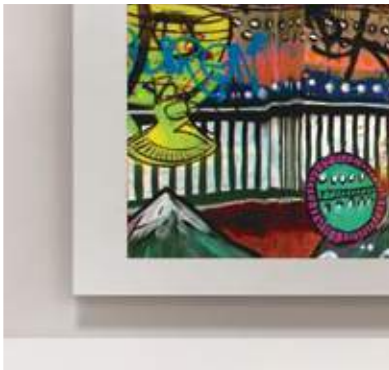

**PAPYRUS** 

Your partner in Visual Communication

# Sign Media 3M

## 3M REFLECTIVE FILMS

3M SCOTCHLITE™ CR 680 . . . . .	67
3M SCOTCHLITE™ SL 580 . . . . .	67
3M DIAMOND GRADE 983 . . . . .	67
3M SCOTCHLITE 13056 (CHEVRON) . . . . .	68
3M™ Vehicle Safety Markings – 823i . . . . .	68
3M DIAMOND GRADE 4083-33 . . . . .	68



## 3M REFLECTIVE FILMS

Color Name			Box Label	Ref. Papyrus	Info	Min. Order m.	€/m.	€/m <sup>2</sup>
------------	--	--	-----------	--------------	------	---------------	------	------------------

### 3M SCOTCHLITE™ CR 680

Een flexibele retroreflecterende folie (200 µm) met een verwijderbare, drukgeactiveerde lijmlaag, voor vlakke en matige gebogen oppervlakken, met of zonder klinknagels. Bezit luchtkanaaltjes in de lijm (Comply™) voor een bellenvrije applicatie. Kan worden gezeefdrukt of digitaal bedrukt. Op aanvraag beschikbaar in 11 kleuren, en goedgekeurd volgens de UN/ECE 104 wetgeving. Een verwachte levensduur van maximaal 8 jaar.

Film rétro réfléchissant souple (200 microns) avec un adhésif amovible activé par la pression. Pour les surfaces planes et courbes modérées, avec ou sans rivets. Adhésif à canaux d'air (Comply™) pour une application sans bulles. Peut être sérigraphié ou imprimé numériquement. Disponible sur demande en 11 couleurs. Conforme à la législation UN/ECE 104. Durée de vie prévue jusqu'à 8 ans.

680CRE-10 White Glossy	1,22	45,7	680C1012	88104812		45,7	59,46	48,74
------------------------	------	------	----------	----------	--	------	-------	-------

### 3M SCOTCHLITE™ SL 580

Een flexibele retroreflecterende folie (200 µm) met een permanente, drukgevoelige lijmlaag. Voor vlakke en matige gebogen oppervlakken, met of zonder klinknagels. Kan worden gezeefdrukt of digitaal bedrukt. Beschikbaar in 11 kleuren, en goedgekeurd volgens de UN/ECE 104 wetgeving. Een verwachte levensduur van maximaal 8 jaar.

Film rétro réfléchissant souple (200 microns) avec un adhésif permanent sensible à la pression. Pour les surfaces courbes planes et modérées avec ou sans rivets. Peut être sérigraphié ou imprimé numériquement. Disponible en 11 couleurs. Conforme à la législation UN/ECE 104. Durée de vie prévue jusqu'à 8 ans.

580E-10 White Glossy	1,22	45,7	5801045	88104759		1	41,18	33,75
580E-14 Orange Glossy	1,22	23	5801422	88104755		1	48,48	39,74
580E-35 Dutch Police Blue	1,22	23	5803522	88156108		1	48,48	39,74
580E-64 Gold Glossy	1,22	23	5806422			23	48,48	39,74
580E-71 Yellow Glossy	1,22	23	5807122	88104768		1	48,48	39,74
580E-72 Red Glossy	1,22	23	5807222	88104799		1	48,48	39,74
580E-75 Blue Glossy	1,22	23	5807522	88104813		1	48,48	39,74
580E-76 Light Blue Glossy	1,22	23	5807622	88104801		1	48,48	39,74
580E-77 Green Glossy	1,22	23	5807722	88161364		1	48,48	39,74
580E-81 Lemon Yellow Glossy	1,22	23	5808122	88104807		1	48,48	39,74
580E-82 Ruby Red Glossy	1,22	23	5808222	88104823		1	48,48	39,74
580E-85 Black Glossy	1,22	23	5808522	88104824		1	48,48	39,74

Color Name			Box Label	Ref. Papyrus	Info	Min. Order m.	€/Roll
------------	--	--	-----------	--------------	------	---------------	--------

### 3M DIAMOND GRADE 983

De 3M™ Diamond Grade™ Tape serie 983 is ontworpen voor contourmarkeringen op voertuigen met harde wanden. De doorlopende 983 tape heeft een uitstekend reflecterend vermogen en hoge helderheid en een garantie van acht jaar. Voldoet aan de UNECE 104 vereisten. Verkrijgbaar in geel, wit en rood.

Marquage de contour pour véhicules 3M™ Diamond Grade™ série 983 destiné à la signalisation de camions rigides afin d'accroître leur visibilité. Le marquage continu 983 assure une excellente rétroreflectivité et visibilité. Garantie de 8 ans.

983-10 Contour WHITE segments 50mm Roll	0,05	50	9831055	88105230		50	125
983-71 Contour YELLOW segments 50mm Roll	0,05	50	9837155	88105231		50	125
983-72 Contour RED segments 50mm Roll	0,05	50	9837255	88105232		50	125



## 3M REFLECTIVE FILMS (Vervolg - Suite)

Color Name			Box Label	Ref. Papyrus	Info	Min. Order m.	€/m.	€/m <sup>2</sup>
------------	--	--	-----------	--------------	------	---------------	------	------------------

### 3M SCOTCHLITE 13056 (CHEVRON)

Retroreflecterende Rood/Wit Film voor Voertuigen en Obstakels, conform wetgeving. Reflecterende films met witte en rode banden van 10cm breed. Conform met het M,B, van 07,05,99. Bestaat in linkse, rechte en visgraat versie.

Film Rétroréfléchissant Rouge/Blanc pour Véhicules et Obstacles, conforme à la législation. Film réfléchissant avec bandes alternées rouge-blanc de 10cm de large. Conforme à l'A,M, du 07,05,99. Existe en version gauche, droite et en chevrons.

13056BE SL Red/White Left version	0,914	45,7	1305691L	88105234		1	22,87	25,02
13056BE SL Red/White Right version	0,914	45,7	1305691R	88105233		1	22,87	25,02



### 3M 823i (Chevron class 2)

Flexibele 3M High Intensity prismatische gemetalliseerde folie voor markeringen op voertuigen van interventiediensten. Serie 823i met drukgevoelige lijm - 3M Comply™ with Controltac™ Liner - Klasse RA2 (tabel A).

Film flexible métallisée prismatique 3M haute intensité pour le marquage sur les véhicules des services d'intervention. Série 823i avec adhésif sensible à la pression - 3M Comply™ avec liner Controltac™ - Classe RA2 (tableau A)

3M 823IVWM 1,220m x 45,7 m - red/white	1,22	45,7	7100057908	88313565		1	46,64	38,23
3M 823IVWML Left 1,220 - red/white	1,22	45,7	7100074092	88313570		1	46,64	38,23
3M 823Ivwmr Right 1,220 - red/white	1,22	45,7	7100075328	88313571		1	46,64	38,23



### 3M DIAMOND GRADE 4083-33

De 3M™ Diamond Grade™ DG<sup>3</sup> Voertuigmarkering van de serie 4083-33 is ontworpen om brandweervoertuigen beter zichtbaar te maken overdag en 's nachts. Deze folie heeft een uitstekend reflecterend vermogen en helderheid dankzij het fluorescerend citroengeel/rood patroon conform DIN 14502-3. Het Franse goedkeuringsnummer „TPESC B 07192 3M“ is erop gedrukt.

Marquage pour véhicules 3M™ Diamond Grade™ DG<sup>3</sup> série 4083-33 destiné à la signalisation de véhicules d'incendie pour une visibilité accrue de jour comme de nuit. Le film 4083-33 garantit une excellente rétroréflexivité et visibilité et alterne des bandes jaune fluo et rouge conformément à la norme DIN 14502-3. L'impression est homologuée « TPESC B 07192 3M » (numéro de l'institut de test français) selon la norme NIT 273:2006.

DG 4083-33 Yellow/red Left version	0,914	45,7	4083339L	88223074		1	68,56	75,01
DG 4083-33 Yellow/red Right version	0,914	45,7	4083339R	88223075		1	68,56	75,01



# Papyrus Viscom

Prijslijst / Liste de prix  
Transfer Media Stahls



**PAPYRUS** 

Your partner in Visual Communication

# Transfert Media Stahls

## Cad-Cut ®

Premium Plus . . . . .	71
Premium Plus Nylon . . . . .	72
Premium Plus Sublistop . . . . .	72
SportsFilm . . . . .	73
BasicFilm. . . . .	74
Flock. . . . .	74
Effekt . . . . .	75
Glitter . . . . .	75
Silicone 200 . . . . .	76
Silicone 500 . . . . .	76
Reflective . . . . .	76

## Cad-Color ®

Cad-Color SuperTEK Opaque . . . . .	77
Cad-Color Solutions Opaque . . . . .	77
Cad-Color SportsFilm . . . . .	77
Cad-Color SuperTEK Sublistop . . . . .	77
Cad-Color Sublistop . . . . .	77
Cad-Color Nylon. . . . .	78
Cad-Color SuperTEK Clear . . . . .	78
Cad-Color Clear . . . . .	78
Cad-Cad-Color FoilTEK . . . . .	78
Cad-Color Glow in the dark . . . . .	78
Cad-Color Solventflock . . . . .	78



## Cad-Cut®

The Cad -Cut line features a wide variety of colored films for textiles. Easily cuttable, flexible and quickly transferred, these films are sure to surprise you.

La gamme Cad-Cut propose une large variété de films colorés pour textiles. Facilement découpable, souples et rapidement transférés, ces films ne manqueront pas de vous surprendre.































### Premium Plus

Strechable and Elasticated • Easy to cut and weed • Matt nish with silky touch • Can be multi layered • Cotton - Polyester - Poly-Cotton - Lycra

Étirable et élastique • Facile à couper et à écheniller • Finition matte et touché soyeux • Superposition de plusieurs couleurs possible, • Cotton - Polyester - Poly-Cotton - Lycra: 100 µ



## Premium Plus

Color Name			Box Label	Ref. Papyrus	Info	Min. Order m.	€/m. 
White	0,5	25	001	88204319		1	6,73
Cream	0,5	25	005	88204337		1	6,73
Lemon	0,5	25	100	88204320		1	6,73
Yellow	0,5	25	110	88204322		1	6,73
Sunflower Yellow	0,5	25	106	88204338		1	6,73
Light Orange	0,5	25	185	88204339		1	6,73
Orange	0,5	25	180	88204323		1	6,73
Red	0,5	25	200	88204325		1	6,73
Signal Red	0,5	25	210	88204324		1	6,73
Burgundy	0,5	25	270	88204326		1	6,73
Pink	0,5	25	252	88204340		1	6,73
Fuschia	0,5	25	250	88204341		1	6,73
Purple	0,5	25	280	88204342		1	6,73
Light Blue	0,5	25	320	88204328		1	6,73
Royal Blue	0,5	25	300	88204329		1	6,73
Navy	0,5	25	350	88204330		1	6,73
Turquoise	0,5	25	380	88204343		1	6,73
Brown	0,5	25	550	88204332		1	6,73
Light Green	0,5	25	422	88204344		1	6,73
Green	0,5	25	400	88204331		1	6,73
Dark Green	0,5	25	410	88204345		1	6,73
Grey	0,5	25	730	88204334		1	6,73
Dark Grey	0,5	25	780	88204335		1	6,73
Black	0,5	25	700	88204336		1	6,73
Silver	0,5	25	815	88204351		1	6,73
Gold	0,5	25	115	88204355		1	6,73
Pastel Apple Green	0,5	25	421	88204362		1	6,73
Pastel Pink	0,5	25	255	88204365		1	6,73
Pastel Purple	0,5	25	285	88204364		1	6,73
Pastel Blue	0,5	25	321	88204366		1	6,73
Pastel Green	0,5	25	420	88204363		1	6,73
Fluo Pink	0,5	25	241	88204358		1	7,55
Fluo Yellow	0,5	25	101	88204356		1	7,55
Fluo Orange	0,5	25	181	88204360		1	7,55
Fluo Blue	0,5	25	301	88204357		1	7,55
Fluo Green	0,5	25	401	88204359		1	7,55



# STAHL'S®

## Premium Plus Nylon

Special material to apply it on Nylontextiles • Easy to cut and weed • Can be multi-layered • Nylon - Nylon blend  
 Matériaux spécial pour tissu en Nylon • Facile à couper et à écheniller • Superposition de plusieurs couleurs possible • Nylon et composé de nylon: 100 µ



## Premium Plus Nylon

Color Name			Box Label	Ref. Papyrus	Info	Min. Order m.	€/m.
White	0,5	25	001	88204391		1	7,73
Lemon	0,5	25	100	88204393		1	7,73
Yellow	0,5	25	110	88204390		1	7,73
Sunflower Yellow	0,5	25	106	88204394		1	7,73
Orange	0,5	25	180	88204397		1	7,73
Light Orange	0,5	25	185	88204420		1	7,73
Red	0,5	25	200	88204400		1	7,73
Burgundy	0,5	25	270	88204401		1	7,73
Fuschia	0,5	25	250	88204416		1	7,73
Light Blue	0,5	25	320	88204407		1	7,73
Royal Blue	0,5	25	300	88204408		1	7,73
Navy	0,5	25	350	88204411		1	7,73
Green	0,5	25	400	88204413		1	7,73
Grey	0,5	25	730	88204414		1	7,73
Black	0,5	25	700	88204415		1	7,73
Silver	0,5	25	815	88204417		1	7,73
Gold	0,5	25	115	88204418		1	7,73
Fluo Pink	0,5	25	241	88204419		1	7,73

## Premium Plus Sublistop

Completely block out sublimation • Low tack backing • Easy to weed • Can be multi-layered • Polyester - Sublimated Polyester - Poly-Cotton

Bloque complètement la sublimation • Faible adhésion du porteur • Facile à couper et à écheniller • Superposition de plusieurs couleurs possible • Polyester - Sublimated Polyester - Poly-Cotton: 100 µ



## Premium Plus Sublistop

Color Name			Box Label	Ref. Papyrus	Info	Min. Order m.	€/m.
White	0,5	25	001	88204523		1	8,73
Cream	0,5	25	105	88204528		1	8,73
Yellow	0,5	25	110	88204524		1	8,73
Light Orange	0,5	25	185	88204529		1	8,73
Red	0,5	25	200	88204525		1	8,73
Light Blue	0,5	25	320	88204526		1	8,73
Turquoise	0,5	25	380	88204534		1	8,73
Light Green	0,5	25	422	88204535		1	8,73
Grey	0,5	25	730	88204527		1	8,73
Silver	0,5	25	815	88204536		1	8,73
Gold	0,5	25	115	88204537		1	8,73





## SportsFilm

Apply in 5 seconds • Hot peel • Thin and sticky material • Perfect for small details • matt finish • Cotton - Polyester - Poly-Cotton  
 Appliqué en 5s, • Pelage à chaud • Matériau fin, Porteur Thermocollant • Parfait pour petits détails • Finition Matte • Cotton - Polyester - Poly-Cotton: 80 µ



## SportsFilm CAD CUT™

Color Name			Box Label	Ref. Papyrus	Info	Min. Order m.	€/m.
White	0,5	25	001	88204218		1	6,46
Cream	0,5	25	005	88204200		1	6,46
Lemon	0,5	25	100	88204214		1	6,46
Yellow	0,5	25	110	88204209		1	6,46
Sunflower Yellow	0,5	25	106	88204226		1	6,46
Light Orange	0,5	25	185	88204203		1	6,46
Orange	0,5	25	180	88204229		1	6,46
Red	0,5	25	200	88204206		1	6,46
Signal Red	0,5	25	210	88204225		1	6,46
Burgundy	0,5	25	270	88204205		1	6,46
Pink	0,5	25	252	88204228		1	6,46
Fuschia	0,5	25	250	88204201		1	6,46
Purple	0,5	25	280	88204227		1	6,46
Light Blue	0,5	25	320	88204285		1	6,46
Royal Blue	0,5	25	300	88204221		1	6,46
Navy	0,5	25	350	88204286		1	6,46
Turquoise	0,5	25	380	88204199		1	6,46
Brown	0,5	25	550	88204204		1	6,46
Light Green	0,5	25	422	88204213		1	6,46
Green	0,5	25	400	88204212		1	6,46
Dark Green	0,5	25	410	88204207		1	6,46
Olive	0,5	25	430	88204198		1	6,46
Grey	0,5	25	730	88204208		1	6,46
Dark Grey	0,5	25	780	88204224		1	6,46
Black	0,5	25	700	88204220		1	6,46
Silver	0,5	25	815	88204223		1	6,46
Gold	0,5	25	115	88204216		1	6,46
Apple Green	0,5	25	421	88204288		1	6,46
Pastel Pink	0,5	25	255	88204291		1	6,46
Pastel Purple	0,5	25	285	88204290		1	6,46
Pastel Blue	0,5	25	321	88204293		1	6,46
Pastel Green	0,5	25	420	88204289		1	6,46
Fluo Pink	0,5	25	241	88204233		1	7,28
Fluo Yellow	0,5	25	101	88204231		1	7,28
Fluo Orange	0,5	25	181	88204232		1	7,28
Fluo Blue	0,5	25	301	88204287		1	7,28
Fluo Green	0,5	25	401	88204234		1	7,28



## BasicFilm

Non sticky material • Ideal for Letters and Numbers • Easy to cut and weed • Matt finish • Cotton - Polyester - Poly-Cotton  
 Surface douce et confortable • Facile à couper et écheniller • Repassable • Cotton - Polyester - Poly-Cotton: 80 µ



## Basic Film CAD CUT™

Color Name			Box Label	Ref. Papyrus	Info	Min. Order m.	€/m.
White	0,5	25	001	88204810		1	5,18
Yellow	0,5	25	110	88204811		1	5,18
Red	0,5	25	200	88204806		1	5,18
Royal Blue	0,5	25	300	88204808		1	5,18
Navy	0,5	25	350	88204805		1	5,18
Gold	0,5	25	115	88204807		1	5,18
Silver	0,5	25	815	88204802		1	5,18
Black	0,5	25	700	88204809		1	5,18
Green	0,5	25	400	88204801		1	5,18

## Flock

For small designs also • Slightly sticky carrier • Soft comfortable surface • Brilliant colours • Cotton - Polyester - Poly-Cotton  
 Idéal pour petit détail • Porteur légèrement Thermocollant • Surface douce • Couleurs éclatantes • Cotton - Polyester - Poly-Cotton: 100 µ



## Flock CAD CUT™

White	0,5	24	001	88204779		1	12,91
Lemon	0,5	24	100	88204766		1	12,91
Yellow	0,5	24	110	88204771		1	12,91
Orange	0,5	24	180	88204781		1	12,91
Red	0,5	24	200	88204782		1	12,91
Signal Red	0,5	24	210	88204772		1	12,91
Magenta	0,5	24	245	88204773		1	12,91
Burgundy	0,5	24	270	88204784		1	12,91
Navy	0,5	24	350	88204777		1	12,91
Royal Blue	0,5	24	300	88204763		1	12,91
Light Blue	0,5	24	320	88204785		1	12,91
Ice Blue	0,5	24	310	88204774		1	12,91
Aqua	0,5	24	390	88204797		1	12,91
Green	0,5	24	400	88204765		1	12,91
Dark Brown	0,5	24	550	88204786		1	12,91
Grey	0,5	24	730	88204767		1	12,91
Anthracite	0,5	24	780	88204780		1	12,91
Black	0,5	24	700	88204770		1	12,91
Fluo Green	0,5	24	401	88204791		1	14,73
Fluo Yellow	0,5	24	101	88204794		1	14,73
Fluo Pink	0,5	24	241	88204793		1	14,73



# STAHL'S®

## Effekt

Top Fashion • Brilliant appearance • Amazing effects • Sticky carrier • Cotton - Polyester - Poly-Cotton  
Tendance mode • Apparence Brillante • Effets spéciaux • Porteur Thermocollant • Cotton - Polyester - Poly-Cotton: 100 µ



## Effekt

Color Name			Box Label	Ref. Papyrus	Info	Min. Order m.	€/m.
Rainbow	0,5	25	900	88204540		1	5,37
Spectrum	0,5	25	901	88204543		1	5,37
Sparkle Red	0,5	25	904	88204545		1	5,37
Sparkle Light Blue	0,5	25	905	88204547		1	5,37
Sparkle Blue	0,5	25	906	88204582		1	5,37
Sparkle Purple	0,5	25	907	88204564		1	5,37
Sparkle Green	0,5	25	908	88204569		1	5,37
Sparkle Pink	0,5	25	909	88204577		1	5,37
Clear	0,5	25	912	88204578		1	5,37
Crystal	0,5	25	913	88204580		1	5,37
Multi	0,5	25	914	88204581		1	5,37

## Glitter

Top Fashion • Brilliant appearance • White can be combined with Sublimation prints • Cotton - Polyester - Poly-Cotton  
Tendance mode • Apparence Brillante • Combinaison possible avec les impressions en sublimations • Cotton - Polyester - Poly-Cotton: 100 µ



## Glitter

Gold	0,5	25	920	88204627		1	10,46
Silver	0,5	25	921	88204628		1	10,46
Blue	0,5	25	922	88204679		1	10,46
Purple	0,5	25	924	88204680		1	10,46
Turquoise Gem	0,5	25	925	88204685		1	10,46
Pink	0,5	25	927	88204701		1	10,46
Black	0,5	25	928	88204705		1	10,46
Multi	0,5	25	929	88204703		1	10,46
Orange	0,5	25	931	88204715		1	10,46
Columbia Blue	0,5	25	930	88204706		1	10,46
Royal Blue	0,5	25	942	88204714		1	10,46
Kelly Green	0,5	25	932	88204716		1	10,46
Holo Gold	0,5	25	935	88204713		1	11,82
Neon Yellow	0,5	25	936	88204712		1	13,00
Neon Orange	0,5	25	939	88204709		1	13,00
Neon Blue	0,5	25	938	88204710		1	13,00
Neon Green	0,5	25	937	88204711		1	13,00
Neon Purple	0,5	25	940	88204708		1	13,00



# STAHL'S®

## Silicone 200

Non sticky material • Ideal for medium to smaller details • Blocking features on Polyester • Matt finish • Cotton - Polyester - Poly-Cotton

Matériau à la mode • Idéal pour la production de petits et moyen détails • Bloque complètement la sublimation • Finition matte • Cotton - Polyester - Poly-Cotton: 100 µ



## Silicone 200 CAD CUT™

Color Name			Box Label	Ref. Papyrus	Info	Min. Order m.	€/m.
White	0,5	25	001	88204819		1	15,91
Red	0,5	25	200	88204817		1	15,91
Light Blue	0,5	25	320	88204816		1	15,91
Royal Blue	0,5	25	300	88204818		1	15,91
Green	0,5	25	400	88204814		1	15,91
Grey	0,5	25	730	88204815		1	15,91
Black	0,5	25	700	88204813		1	15,91

## Silicone 500

Non sticky material • Unique 3D look • Blocking features on Polyester • Matt finish • Cotton - Polyester - Poly-Cotton

Matériau à la mode • Effet 3D extraordinaire • Bloque complètement la sublimation • Finition matte • Cotton - Polyester - Poly-Cotton: 100 µ



## Silicone 500 CAD CUT™

Color Name			Box Label	Ref. Papyrus	Info	Min. Order m.	€/m.
White	0,5	25	001	88204829		1	23,55
Red	0,5	25	200	88204826		1	23,55
Light Blue	0,5	25	320	88204825		1	23,55
Royal Blue	0,5	25	300	88204828		1	23,55
Green	0,5	25	400	88204822		1	23,55
Grey	0,5	25	730	88204823		1	23,55
Black	0,5	25	700	88204820		1	23,55

## Reflective

No tack backing • Easy to cut and weed • Reflective material • Certificated Din EN 20471 • Cotton - Polyester - Poly-Cotton

Liner non Adhésif • Facile à couper et à écheniller • Matériau réfléchissant certifié DIN EN 20471 • Cotton - Polyester - Poly-Cotton: 100 µ



## Reflective CAD CUT™

Color Name			Box Label	Ref. Papyrus	Info	Min. Order m.	€/m.
Silver	0,5	25	471	88309585		25	9,41



## Cad-Color®

Printable applicable on textile media • Full range of polyurethanes • Wide range of colors • incredible Sustainability  
 Média imprimable applicables sur textile • Gamme complète en polyuréthane • Large choix de couleurs • Durabilité incroyable

Cad-Color name			Ref. Papyrus	Info	€/roll 	€/m <sup>2</sup> 
----------------	--	--	-----------------	------	------------	----------------------

### Cad-Color SuperTEK Opaque

Highly flexible • Very thin • Easy to print • Matte finish • Cotton - Polyester - Poly-Cotton  
 Très fin • Hautement extensible • Facile à imprimer • Finition matte • Cotton - Polyester - Poly-Cotton: 100 µ

					<b>SuperTEK™ Opaque</b>	
--	--	--	--	--	-------------------------	--

Cad-Color SuperTEK Opaque	0,5	25	88204076		197,75	15,82
---------------------------	-----	----	----------	--	--------	-------

### Cad-Color Solutions Opaque

Very thin • Highly exible • Amazing brilliant colours • Fine details can be cut • Cotton - Polyester - Poly-Cotton - Nylon - Lycra  
 Très fin • Hautement extensible • Couleurs brilliantes • Coupe de détails fins possible • Cotton - Polyester - Poly-Cotton - Nylon - Lycra: 100 µ

					<b>Solutions™ Opaque</b>	
--	--	--	--	--	--------------------------	--

Cad-Color Solutions Opaque	0,61	30	88204039		617,26	33,73
----------------------------	------	----	----------	--	--------	-------

### Cad-Color SportsFilm

Apply in 5 seconds • Peel hot • Matte finish • Fine details can be cut • Cotton - Polyester - Poly-Cotton  
 Pressez seulement 5 seconds • Pélage à chaud • Finition matte • Découpe de détails fins possible • Cotton - Polyester - Poly-Cotton: 100 µ

					<b>SportsFilm</b>	
--	--	--	--	--	-------------------	--

CAD-COLOR SportsFilm	0,5	25	88204037		177,25	14,18
----------------------	-----	----	----------	--	--------	-------

### Cad-Color SuperTEK Sublistop

Flexible • Thin • With Sublistop • Matte finish • Cotton - Polyester - Poly-Cotton - Nylon - Nylon composé  
 Extensible • Fin • Barrière protectrice de sublimation • Finition matte • Cotton - Polyester - Poly-Cotton - Nylon - Nylon composé: 100 µ

					<b>SuperTEK™ Sublistop</b>	
--	--	--	--	--	----------------------------	--

Cad-Color SuperTEK Sublistop	0,5	22,8	88204077		242,48	21,27
------------------------------	-----	------	----------	--	--------	-------

### Cad-Color Sublistop

Special material for sublimated polyester fabrics • Brilliant colours • Easy to print and cut • Polyester - Poly-Cotton  
 Film spécial pour tissus de sublimation • Couleurs brilliantes • Facile à imprimer et à couper • Polyester - Poly-Cotton: 100 µ

					<b>Sublistop</b>	
--	--	--	--	--	------------------	--

Cad-Color Sublistop	0,5	25	88204115		243,13	19,45
---------------------	-----	----	----------	--	--------	-------



Cad-Color name			Ref. Papyrus	Info	€/roll	
----------------	--	--	-----------------	------	--------	--

## Cad-Color Nylon

Special material for most nylon fabrics • Brilliant colours • Easy to print and to cut • Nylon  
 Film spécial pour la plupart des tissus nylon • Couleurs brillantes • Facile à imprimer et à couper • Nylon: 100 µ

				<b>Nylon</b>
--	--	--	--	--------------

Cad-Color Nylon	0,5	25	88204116		215,88	17,27
-----------------	-----	----	----------	--	--------	-------

## Cad-Color SuperTEK Clear

Available in matte or gloss • Highly flexible • Very thin and soft • Single step application • Cotton - Polyester - Poly-Cotton - Nylon - Lycra  
 Finition matte ou brillante disponible • Hautement extensible • Très fin et doux • Tape d'application non nécessaire • Cotton - Polyester - Poly-Cotton - Nylon - Lycra: 100 µ

					<b>SuperTEK™ Clear</b>
--	--	--	--	--	------------------------

Cad-Color SuperTEK Clear Gloss	0,5	22,8	88204061		180,35	15,82
Cad-Color SuperTEK Clear Matt	0,5	25	88204072		197,75	15,82

## Cad-Color Clear

: 100 µ

					<b>Clear</b>
--	--	--	--	--	--------------

Cad-Color Clear	0,5	25	88204114		176,13	14,09
-----------------	-----	----	----------	--	--------	-------

## Cad-Cad-Color FoilTEK

Available in gold and silver • Easy to print • Metallic Effect with matte finish • Cotton - Polyester - Poly-Cotton - Nylon  
 Or et argent disponible • Facile à couper • Effet métallique avec finition matte • Cotton - Polyester - Poly-Cotton - Nylon: 100 µ

					<b>FoilTEK™</b>
--	--	--	--	--	-----------------

CaCad-Color FoilTEK Silver Met,	0,5	22,8	88204079		241,45	21,18
CaCad-Color FoilTEK Gold Met,	0,5	22,8	88204080		241,45	21,18
CaCad-Color FoilTEK White Met,	0,5	22,8	88204081		241,45	21,18

## Cad-Color Glow in the dark

Photo luminescent • Bring any design to life after dark • Fashionable! • Cotton - Polyester - Poly-Cotton  
 Photo luminescent • Révélez tous vos motifs dans le noir • Tendance • Cotton - Polyester - Poly-Cotton: 100 µ

					<b>Glow in the Dark</b>
--	--	--	--	--	-------------------------

Cad-Color Glow in the dark	0,5	25	88204082		311,38	24,91
----------------------------	-----	----	----------	--	--------	-------

## Cad-Color Solventflock

Soft and comfortable surface • Easy cutting and weeding • Ironable • Cotton - Polyester - Poly-Cotton  
 Surface douce et confortable • Facile à couper et écheniller • Repassable • Cotton - Polyester - Poly-Cotton: 100 µ

				<b>Solvent Flock</b>
--	--	--	--	----------------------

Cad-Color Solventflock	0,5	25	88204117		325	26
------------------------	-----	----	----------	--	-----	----

# Papyrus Viscom

Prijslijst / Liste de prix

Print Media: Solvent - UV - Latex - Avery

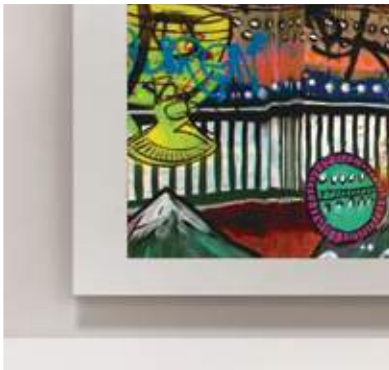

PAPYRUS 

Your partner in Visual Communication





# Solvent/UV/Latex Print Media Avery

## CAST Print Vinyl

Standard Range	83
Avery MPI 1105 Wrapping Film Wit glanzend - Blanc brillant	83
Avery MPI 1104 cast Wit glanzend - Blanc brillant	83
Avery MPI 1106 Hi-Tack cast Wit glanzend - Blanc brillant	83
Avery MPI 1106 EA Hi-Tack cast Wit glanzend - Blanc brillant	83
E.A.R.S.: EASY APPLY ( Air-escape technology) and Repositionable and Slidable	83
Avery MPI 1105 EARS Wrapping Film Wit glanzend Blanc brillant	83
E.A.: EASY APPLY ( Air-escape technology)	83
Avery MPI 1104 EA cast Wit glanzend - Blanc brillant	84

## CAST Laminates

Avery DOL 1460Z Hoogglanzend 3D-Laminaat - Laminat 3D très brillant	84
Avery DOL 1470Z Semi-glanzend (lustre) 3D Laminaat - Laminat 3D Satiné	84
Avery DOL 1480Z Mat 3D-Laminaat - Laminat 3D mat	84
Avery DOL 6040 Sparkle Clear Glanzend Sparkle Laminaat - Laminat Transparant pailleté Brillant	84
E.A.R.S.: EASY APPLY ( Air-escape technology) and Repositionable and Slidable	84
Avery MPI 1405 EARS Wit glanzend - Blanc brillant	84

## Polyurethane Free PVC Laminates

Avery DOL 6460 Glanzend 3D-Laminaat - Laminat 3D brillant	84
---	----

## WHITE POLYMERIC Print Vinyls

Standard Range	85
Avery MPI 2000 HOP Wit glanzend - Blanc brillant	85
Avery MPI 2006 HOP Hi-Tack Wit glanzend Ondoorzichtig - Blanc brillant Opaque	85
Avery MPI 2001 HOP Wit glanzend - Blanc brillant	85
Avery MPI 2800 HOP Wit glanzend - Blanc brillant	85
Avery MPI 2801 HOP Wit glanzend - Blanc brillant	85
Avery MPI 2003 Wit glanzend opaak - Blanc brillant opaque	85
Avery MPI 2020 Wit mat - Blanc mat	85
E.A.: EASY APPLY ( Air-escape technology)	86
Avery MPI 2004 E.A. HOP Wit glanzend - Blanc brillant	86
Avery MPI 2804 E.A. Wit glanzend - Blanc brillant	86
E.A.R.S.: EASY APPLY ( Air-escape technology) and Repositionable and Slidable	86
Avery MPI 2005 EARS Wit glanzend - Blanc brillant	86

## TRANSPARENT POLYMERIC Print Vinyls

Avery MPI 2040 Transparant glanzend - Transparent brillant	86
Avery MPI 2041 Transparant glanzend - Transparent brillant	86
Avery MPI 2150 Translucent half-glanzend - Translucent semi-brillant	86

## POLYMERIC Laminates

Avery DOL 2460 Glanzend laminaat - Laminat brillant	87
Avery DOL 2480 Mat laminaat - Laminat mat	87
Avery DOL 2200 Semi-matt (lustre) Laminaat - Laminat semi-matt (lustre)	87
Avery DOL 2470 Semi-matt (lustre) Laminaat - Laminat semi-matt (lustre)	87
Avery DOL 2860 Glanzend promotioneel Laminaat - Laminat brillant promotionnel	87
Avery DOL 2880 Mat promotioneel Laminaat - Laminat mat promotionnel	87

## GLOSS WHITE MONOMERIC Print Vinyls

Avery MPI 3000 Wit glanzend - Blanc brillant	88
Avery MPI 3000 HOP (high Opacity) Wit glanzend - Blanc brillant	88
Avery MPI 3001 Wit glanzend - Blanc brillant	88
Avery MPI 3001 HOP (high Opacity) Wit glanzend - Blanc brillant	88
Avery MPI 3601 Wit glanzend quick mount - Blanc brillant - Pose facile	88
Avery MPI 3020 HOP (high Opacity) Wit mat - Blanc mat	88
Avery MPI 3021 HOP (high Opacity) Wit mat - Blanc mat	88
Avery MPI 3026 Wit mat - Blanc mat	88
E.A.: EASY APPLY ( Air-escape technology)	88
Avery MPI 3004 HOP Gloss EA Wit glanzend - Blanc brillant	88
Avery MPI 3024 HOP Gloss EA Wit mat - Blanc mat	88

## GLOSS TRANSPARENT MONOMERIC Print Vinyls

Avery MPI 3040 Transparant glanzend - Transparent brillante	89
Avery MPI 3041 Transparant glanzend - Transparent brillante	89
Avery MPI 3151 Translucent semi-glanzend - Transslucente semi-brillante	89
Avery DOL 3460 Glanzend laminaat - Laminat brillant	89
Avery DOL 3480 Mat Laminaat - Laminat mat	89
Avery DOL 3200 Semi-glanzend (lustre) Laminaat - Laminat semi-brillant (lustre)	89
Avery DOL 3470 Semi-glanzend (lustre) Laminaat - Laminat semi-brillant (lustre)	89

## Avery MPI 7000 Perforated Window Film Series

Avery MPI 7101 PWF Polymeer Wit Glanzend - Polymère Blanc brillant . . . . .	90
Avery MPI 7201 PWF Polymeer Wit Glanzend - Polymère Blanc brillant . . . . .	90
Avery MPI 7301 PWF Polymeer Wit Glanzend - Polymère Blanc brillant . . . . .	90
Avery MPI 7401 PWF Monomeer Wit Glanzend - Monomère Blanc brillant . . . . .	90

## Avery SF100 Ultra Clear

Avery SF100 Ultra Clear Film Transparant glanzend Polyester - Polyester Transparent brillant . . . . .	90
--	----

## Avery MPI 8000 Wall Film Series

Avery MPI 8726 - Canvas Canvas structuur - Texture Canvas . . . . .	91
Avery MPI 8726 - Stucco Stucco structuur - Texture Stucco . . . . .	91
Avery MPI 8726 - Stone Stone structuur - Texture Stone . . . . .	91
Avery MPI 8024 Wit mat zonder structuur - Blanc Mat Non-Texturé . . . . .	91
Avery MPI 8621 Wit mat zonder structuur - Blanc Mat Non-Texturé . . . . .	91
Avery MPI 8520 (PVC Free) Muurschildering behang - Papier peint Mural . . . . .	91
Avery MPI 8826 High-Tack textielfilm - canvasafwerking - Film Textile High-Tack - Finition Canevas. . . . .	91

## Avery MPI 6021 ANTI-SLIP FLOOR MARKING

Avery MPI 6021 Getextureerd mat wit - Blanc mat texturé . . . . .	91
---	----



## CAST Print Vinyl

Zelfklevende gegoten vervormbare vinyls  
Vinyles adhésifs coulés déformables

				Ref. Papyrus	Info	€/roll 	€/m <sup>2</sup> 
--	--	--	--	-----------------	------	------------	----------------------

### Standard Range

<b>Avery MPI 1105 Wrapping Film Wit glanzend - Blanc brillant</b>							
Grijze herpositioneerbare permanente lijm - Adhésif gris permanent repositionnable							
50	1,37	50	10	88183867		952,03	13,90
<b>Avery MPI 1104 cast Wit glanzend - Blanc brillant</b>							
Grijze herpositioneerbare permanente lijm - Adhésif gris permanent repositionnable							
50	1,37	25	7	88165632		348,49	10,17
	1,37	50	7	88165633		696,99	10,17
	1,52	25	7	88171231		386,65	10,17
	1,52	50	7	88171232		773,30	10,17
<b>Avery MPI 1106 Hi-Tack cast Wit glanzend - Blanc brillant</b>							
Grijze sterk hechtende lijm - Adhésif gris renforcé							
50	1,37	25	7	88240895		414,81	12,11
<b>Avery MPI 1106 EA Hi-Tack cast Wit glanzend - Blanc brillant</b>							
Grijze sterk hechtende lijm - Easy Apply TM - technologie maakt het gemakkelijk aan te brengen dankzij een snelle, eenvoudige en bellenvrije applicatie - Adhésif gris renforcé - Technologie Easy Apply TM permet de faciliter la pose grâce à une application rapide, facile et sans bulle							
50	1,37	25	7	88240897		471,28	13,76

### E.A.R.S.: EASY APPLY ( Air-escape technology) and Repositionable and Slidable

<b>Avery MPI 1105 EARS Wrapping Film Wit glanzend Blanc brillant</b>							
Grijze lijm "easy apply" permanent - herpositioneerbaar, slidable - gemakkelijk verwijderbaar na gebruik - Adhésif gris "easy apply" permanent, repositionnable, ajustable - facile à enlever après usage							
50	1,37	25	10	88183861		544,01	15,88
	1,37	50	10	88183855		1088,03	15,88
	1,52	25	10	88183863		603,58	15,88
	1,52	50	10	88183866		1207,16	15,88

### E.A.: EASY APPLY ( Air-escape technology)

<b>Avery MPI 1104 EA cast Wit glanzend - Blanc brillant</b>							
Grijze lijm "easy apply" permanent, herpositioneerbaar Adhésif gris "easy apply" permanent, repositionnable (long term removability)							
50	1,067	25	7	88236233		297,29	11,15
	1,37	25	7	88165629		381,72	11,15
	1,37	50	7	88165630		763,43	11,15
	1,52	25	7	88171233		423,51	11,15
	1,52	50	7	88171234		847,02	11,15



## CAST Laminates

Zelfklevende gegoten vinylaminaten (transparant)  
Vinyles de pelliculage coulés adhésifs (transparent)

					Ref. Papyrus	Info	€/roll 	€/m <sup>2</sup> 
<b>Avery DOL 1460Z Hoogglanzend 3D-Laminaat - Laminat 3D très brillant</b>								
30	1,37	25		6	88222131		341,89	9,98
	1,37	50		6	88222132		683,77	9,98
	1,52	25		6	88222136		379,32	9,98
	1,52	50		6	88222139		758,64	9,98
<b>Avery DOL 1470Z Semi-glanzend (lustre) 3D Laminaat - Laminat 3D Satiné</b>								
	1,37	50		6	88283561		846,91	12,36
	1,52	50		6	88283562		939,64	12,36
<b>Avery DOL 1480Z Mat 3D-Laminaat - Laminat 3D mat</b>								
30	1,37	25		6	88222143		341,89	9,98
	1,37	50		6	88222144		683,77	9,98
	1,52	25		6	88222145		379,32	9,98
	1,52	50		6	88222146		758,64	9,98
<b>Avery DOL 6040 Sparkle Clear Glanzend Sparkle Laminaat - Laminat Transparant pailletté Brillant</b>								
76	1,37	25		3	88241599		543,50	15,87



## Polyurethane Film - Free PVC

Zelfklevende vervormbare Polyurethane

Polyuréthane adhésifs déformables. Convient pour les surfaces aux textures difficiles, notamment la brique et les blocs de béton. Ce film est aussi un choix exceptionnel pour le marquage des véhicules d'une flotte et pour le covering de véhicules, grâce à sa saturation des couleurs et à l'extensibilité du film.

					Ref. Papyrus	Info	€/roll 	€/m <sup>2</sup> 
<b>E.A.R.S.: EASY APPLY ( Air-escape technology) and Repositionable and Slidable</b>								

Avery MPI 1405 EARS Wit glanzend - Blanc brillant

Grijze lijm "easy apply" permanent - herpositioneerbaar, slidable - gemakkelijk verwijderbaar na gebruik Adhésif gris "easy apply" permanent, repositionnable, ajustable - facile à enlever après usage latex

51	1,37	50		12	88240018		1160,69	16,94
	1,52	50		12	88240017		1287,78	16,94

## Polyurethane Free PVC Laminates

Zelfklevende laminaten (transparant) Geschikt voor MPI 1460  
Vinyles de pelliculage adhésifs (transparent) Convient pour MPI 1460

					Ref. Papyrus	Info	€/roll 	€/m <sup>2</sup> 
<b>Avery DOL 6460 Glanzend 3D-Laminaat - Laminat 3D brillant</b>								
38	1,37	50			88240022		893,22	13,04
	1,52	50			88240020		991,02	13,04



## WHITE POLYMERIC Print Vinyls

Witte gekalanderde zelfklevende polymeervinyls  
Vinyles adhésifs calandrés polymères blancs

				Ref. Papyrus	Info	€/roll 	€/m <sup>2</sup> 
--	--	--	--	-----------------	------	------------	----------------------

### Standard Range

#### Avery MPI 2000 HOP Wit glanzend - Blanc brillant

Permanente lijm - Adhésif permanent

80	1,067	50	7	88227108		293,74	5,51
	1,37	50	7	88227109		377,15	5,51
	1,6	50	7	88227112		440,47	5,51

#### Avery MPI 2006 HOP Hi-Tack Wit glanzend Ondoorzichtig - Blanc brillant Opaque

Transparante sterk hechtende lijm - Adhésif transparent renforcé

80	1,37	25	7	88285258		198,11	5,78
	1,37	50	7	88285256		396,22	5,78

#### Avery MPI 2001 HOP Wit glanzend - Blanc brillant

Verwijderbare lijm - Adhésif enlevable

80	1,067	50	7	88227114		293,74	5,51
	1,37	50	7	88227115		377,15	5,51
	1,6	50	7	88227116		440,47	5,51

#### Avery MPI 2800 HOP Wit glanzend - Blanc brillant

Permanente lijm - Adhésif permanent

80	1,067	50	6	88227117		214,07	4,01
	1,37	50	6	88227118		274,86	4,01
	1,6	50	6	88227119		321,00	4,01

#### Avery MPI 2801 HOP Wit glanzend - Blanc brillant

Verwijderbare lijm - Adhésif enlevable

80	1,37	50	6	88227120		274,86	4,01
	1,6	50	6	88227121		321,00	4,01

#### Avery MPI 2003 Wit glanzend opaak - Blanc brillant opaque

Grijze herpositioneerbare permanente lijm - Adhésif gris permanent repositionnable

80	1,52	50	7	88125624		418,45	5,51
----	------	----	---	----------	--	--------	------

#### Avery MPI 2020 Wit mat - Blanc mat

Permanente lijm - Adhésif permanent

80	1,37	50	7	88105437		418,15	6,10
----	------	----	---	----------	--	--------	------



## WHITE POLYMERIC Print Vinyls (Vervolg)

Witte gekalanderde zelfklevende polymeervinyls  
Vinyles adhésifs calandrés polymères blancs

		Ref.	Info		
--	--	------	------	--	--

### E.A.: EASY APPLY ( Air-escape technology)

**Avery MPI 2004 E.A. HOP Wit glanzend - Blanc brillant**

Grijze permanente "easy apply" lijm, herpositioneerbaar - Adhésif gris permanent "easy apply", repositionnable

80	1,067	50	7	88252861		356,81	6,69
	1,37	50	7	88252862		458,14	6,69
	1,52	50	7	88252863		508,30	6,69

**Avery MPI 2804 E.A. Wit glanzend - Blanc brillant**

Grijze permanente "easy apply" lijm, herpositioneerbaar - Adhésif gris permanent "easy apply", repositionnable

75	1,37	50	6	88151191		338,33	4,94
	1,52	50	6	88151195		375,37	4,94

### E.A.R.S.: EASY APPLY ( Air-escape technology) and Repositionable and Slidable

**Avery MPI 2005 EARS Wit glanzend - Blanc brillant**

Grijze permanent "easy apply" lijm, herpositioneerbaar, slidable - gemakkelijk verwijderbaar na gebruik - Adhésif gris permanent "easy apply" repositionnable, ajustable - facile à enlever après usage

80	1,37	50	7	88156027		627,69	9,16
	1,52	50	7	88122371		696,41	9,16



## TRANSPARENT POLYMERIC Print Vinyls

Transparante gekalanderde zelfklevende polymeervinyls  
Vinyles adhésifs calandrés polymères transparents

		Ref.	Info		
--	--	------	------	--	--

**Avery MPI 2040 Transparant glanzend - Transparent brillant**

Permanente lijm - Adhésif permanent

80	1,067	50	7	88111028		325,34	6,10
	1,37	50	7	88105441		417,73	6,10
	1,52	50	7	88105454		463,46	6,10
	1,6	50	7	88205355		487,85	6,10

**Avery MPI 2041 Transparant glanzend - Transparent brillant**

Verwijderbare lijm (2 jaar) - Adhésif enlevable (2 ans)

80	1,37	50	7	88105414		417,85	6,10
----	------	----	---	----------	--	--------	------

**Avery MPI 2150 Translucent half-glanzend - Translucent semi-brillant**

Permanente lijm - Adhésif permanent

90	1,067	50	8			603,97	11,32
	1,37	50	8	88105471		775,48	11,32
	1,52	50	8	88111962		860,39	11,32



## POLYMERIC Laminates

Zelfklevende gekalanderde polymeervinylaminaten (transparant)  
Vinyles de pelliculage adhésifs calandrés polymères (transparent)

					Ref. Papyrus	Info	€/roll 	€/m <sup>2</sup> 
<b>Avery DOL 2460 Glanzend laminaat - Laminat brillant</b>								
80	1,067	50			88247111		305,73	5,73
	1,37	50			88247114		392,55	5,73
	1,52	50			88247118		435,53	5,73
	1,6	50			88247120		458,45	5,73
<b>Avery DOL 2480 Mat laminaat - Laminat mat</b>								
80	1,067	50			88247121		305,73	5,73
	1,37	50			88247159		392,55	5,73
	1,52	50			88247160		435,53	5,73
	1,6	50			88247161		458,45	5,73
<b>Avery DOL 2200 Semi-matt (lustre) Laminaat - Laminat semi-matt (lustre)</b>								
80	1,52	50			88105453	End of stock	463,46	6,10
<b>Avery DOL 2470 Semi-matt (lustre) Laminaat - Laminat semi-matt (lustre)</b>								
80	1,067	50			88247162		325,34	6,10
	1,37	50			88247158		417,73	6,10
	1,6	50			88297040		487,85	6,10
<b>Avery DOL 2860 Glanzend promotioneel Laminaat - Laminat brillant promotionnel</b>								
80	1,067	50			88247171		214,07	4,01
	1,37	50			88247169		274,86	4,01
	1,52	50			88247168		304,95	4,01
	1,6	50			88247172		321,00	4,01
<b>Avery DOL 2880 Mat promotioneel Laminaat - Laminat mat promotionnel</b>								
80	1,067	50			88247177		208,82	3,91
	1,37	50			88247175		268,12	3,91
	1,52	50			88247173		297,48	3,91
	1,6	50			88247178		313,13	3,91



## WHITE MONOMERIC Print Vinyls

Wit, zelfklevende monomeer gekalanderde vinyls  
Vinyles adhésifs calandrés monomères, blancs

				Ref. Papyrus	Info	€/roll 	€/m <sup>2</sup> 
--	--	--	--	-----------------	------	------------	----------------------

### Avery MPI 3000 Wit glanzend - Blanc brillant Permanente lijm - Adhésif permanent

95	1,52	50	5	88125661	End of stock	161,72	2,13
----	------	----	---	----------	--------------	--------	------

### Avery MPI 3000 HOP (high Opacity) Wit glanzend - Blanc brillant Permanente lijm - Adhésif permanent

95	1,067	50	5	88205360		110,75	2,08
	1,37	50	5	88205367		142,20	2,08
	1,6	50	5	88205375		166,07	2,08

### Avery MPI 3001 Wit glanzend - Blanc brillant Verwijderbare lijm - Adhésif enlevable

95	1,52	50	5	88125662		161,72	2,13
----	------	----	---	----------	--	--------	------

### Avery MPI 3001 HOP (high Opacity) Wit glanzend - Blanc brillant Verwijderbare lijm - Adhésif enlevable

95	1,067	50	5	88205361		110,75	2,08
	1,37	50	5	88205370		142,20	2,08
	1,6	50	5	88205376		166,07	2,08

### Avery MPI 3601 Wit glanzend quick mount - Blanc brillant - Pose facile Verwijderbare lijm - Adhésif enlevable

150	1,37	50	5	88125658		323,29	4,72
	1,6	50	5	88125659		377,56	4,72

### Avery MPI 3020 HOP (high Opacity) Wit mat - Blanc mat Transparante permanente lijm - Adhésif transparent permanent

95	1,067	50	3	88205365		110,75	2,08
	1,37	50	3	88205374		142,20	2,08
	1,6	50	3	88205378		166,07	2,08

### Avery MPI 3021 HOP (high Opacity) Wit mat - Blanc mat Transparante verwijderbare lijm - Adhésif transparent enlevable

95	1,067	50	3	88205363		110,75	2,08
	1,37	50	3	88205371		142,20	2,08
	1,6	50	3	88205377		166,07	2,08

### Avery MPI 3026 Wit mat - Blanc mat Transparante sterk hechtende lijm - Adhésif transparent renforcé

95	1,37	50	3	88207723		243,64	3,56
----	------	----	---	----------	--	--------	------

## E.A.: EASY APPLY ( Air-escape technology)

### Avery MPI 3004 HOP Gloss EA Wit glanzend - Blanc brillant Wit permanente "easy apply" lijm, herpositioneerbaar - Adhésif transparent enlevable "easy apply"

95	1,37	50	3	88241604		205,46	3,00
----	------	----	---	----------	--	--------	------

### Avery MPI 3024 HOP Gloss EA Wit mat - Blanc mat Wit permanente "easy apply" lijm, herpositioneerbaar - Adhésif transparent enlevable "easy apply"

95	1,37	50	3	88241605		211,58	3,09
----	------	----	---	----------	--	--------	------





## GLOSS TRANSPARENT MONOMERIC Print Vinyls

Transparent, glanzende, zelfklevende monomeer gekalanderde vinyls  
Vinyles adhésifs calandrés monomères transparents brillants

				Ref.	Info	€/roll	€/m <sup>2</sup>
				Papyrus			

### Avery MPI 3040 Transparant glanzend - Transparent brillante

Permanente lijm - Adhésif permanent

100	1,067	50	3	88116565		113,52	2,13
	1,37	50	3	88125669		145,76	2,13
	1,6	50	3	88121984		170,23	2,13

### Avery MPI 3041 Transparant glanzend - Transparent brillante

Verwijderbare lijm - Adhésif enlevable

100	1,067	50	3	88114771		113,52	2,13
	1,37	50	3	88100963		145,76	2,13
	1,6	50	3	88125671		170,23	2,13

### Avery MPI 3151 Translucent semi-glanzend - Translucente semi-brillante

Verwijderbare lijm - Adhésif enlevable

86	1,37	50	5	88105455		151,17	2,21
----	------	----	---	----------	--	--------	------



## MONOMERIC Laminates

Zelfklevende gekalanderde monomeervinylaminaten (transparant)  
Vinyles de pelliculage adhésifs calandrés monomères (transparent)

					Ref. Papyrus	Info	€/roll 	€/m <sup>2</sup> 
<b>Avery DOL 3460 Glanzend laminaat - Laminat brillant</b>								
80	1,067	50			88247185		125,50	2,35
	1,37	50			88247186		161,14	2,35
	1,6	50			88247188		188,20	2,35
<b>Avery DOL 3480 Mat Laminaat - Laminat mat</b>								
80	1,067	50			88247189		125,50	2,35
	1,37	50			88247190		161,14	2,35
	1,6	50			88247191		188,20	2,35
<b>Avery DOL 3200 Semi-glanzend (lustre) Laminaat - Laminat semi-brillant (lustre)</b>								
80	1,067	50			88105515	End of Stock	125,50	2,35
<b>Avery DOL 3470 Semi-glanzend (lustre) Laminaat - Laminat semi-brillant (lustre)</b>								
80	1,067	50			88247193		125,50	2,35
	1,37	50			88247194		161,14	2,35
	1,55	50			88247195		182,32	2,35
	1,6	50			88247196		188,20	2,35



## Avery MPI 7000 Perforated Window Film Series

Het Avery MPI 7000 PWF gamma, is samengesteld uit gekalanderde geperforeerde films, met zwarte lijm voor toepassing op glas. Deze vinyls tonen de visual langs de geprinte zijde, en laten een doorkijk mogelijk via de niet geprinte zijde.

La gamme de films Avery MPI 7000 Perforated Window est composée de films calandrés, perforés dotés d'un verso noir à utiliser sur les vitres. Ce film une fois imprimé, permet de voir sur une face le graphique imprimé dans sa totalité, tout en laissant voir à travers le film de l'intérieur du local.

				Ref. Papyrus	Info	€/roll 	€/m <sup>2</sup> 
<b>Avery MPI 7101 PWF Polymeer Wit Glanzend - Polymère Blanc brillant</b> Verwijderbare lijm - Adhésif enlevable							
180μ	1,37	50	3	88190688		1914,93	27,96
<b>Avery MPI 7201 PWF Polymeer Wit Glanzend - Polymère Blanc brillant</b> Verwijderbare lijm - Adhésif enlevable							
180μ	1,37	50	3	88190696		1914,93	27,96
<b>Avery MPI 7301 PWF Polymeer Wit Glanzend - Polymère Blanc brillant</b> Verwijderbare lijm - Adhésif enlevable							
140μ	1,37	50	3	88190699		1127,66	16,46
<b>Avery MPI 7401 PWF Monomeer Wit Glanzend - Monomère Blanc brillant</b> Verwijderbare lijm - Adhésif enlevable							
100μ	1,37	50	3	88190701		834,16	12,18



## Avery SF100 Ultra Clear

Het gamma SF100 bevat een glasheldere film, waarmee ganse raampartijen kunnen bekleefd worden, niet geprinte partijen moeten niet contour gesneden worden. Snel, en eenvoudig.

La gamme SF 100 utilise un film et adhésif ultra clair qui permet de couvrir entièrement les fenêtres, Ainsi, la zone non imprimée conserve la clarté du verre sans qu'il soit nécessaire de découper le film autour de l'image – une installation rapide et facile.

				Ref. Papyrus	Info	€/roll 	€/m <sup>2</sup> 
<b>Avery SF100 Ultra Clear Film Transparant glanzend Polyester - Polyester Transparent brillant</b> Verwijderbare lijm - Adhésif enlevable							
51μ	1,37	50	2	88190702		723,41	10,56
	1,52	50	2			802,62	10,56



## Avery MPI 8000 Wall Film Series

De verschillende lijmsorten bieden de mogelijkheid unieke muurdecoraties te creëren, zowel voor korte als lange termijn, voor toepassing in ontvangstruimtes, winkels, tentoonstellingen etc...

Deze vinyls kunnen aangebracht worden zonder primer, en bieden een perfecte opaciteit t,o,v, eender dewelke ondergrond.

La large gamme d'adhésifs permet de créer une décoration murale en vinyle unique sur le court et le long terme dans des espaces d'accueil, des surfaces commerciales, des foires et bien plus encore. Les films peuvent être appliqués sans apprêt et l'opacité exceptionnelle garantit que le mur en dessous est complètement dissimulé.

		Ref. Papyrus	Info	€/roll 	€/m <sup>2</sup> 
<b>Avery MPI 8726 - Canvas Canvas structuur - Texture Canvas</b> Hi-Tack lijm - Adhésif Hi-Tack					
150µ 1,37 25		88187007		323,82	9,45
<b>Avery MPI 8726 - Stucco Stucco structuur - Texture Stucco</b> Hi-Tack lijm - Adhésif Hi-Tack					
150µ 1,37 25		88187012		323,82	9,45
<b>Avery MPI 8726 - Stone Stone structuur - Texture Stone</b> Hi-Tack lijm - Adhésif Hi-Tack					
200µ 1,37 25		88187013		323,82	9,45
<b>Avery MPI 8024 Wit mat zonder structuur - Blanc Mat Non-Texturé</b> Easy Apply Hi-Tack lijm - Adhésif Hi-Tack Easy Apply					
90µ 1,37 45,7		88187017		591,94	9,45
<b>Avery MPI 8621 Wit mat zonder structuur - Blanc Mat Non-Texturé</b> Verwijderbare lijm - Adhésif enlevable					
150µ 1,37 45,7		88179849		591,94	9,45
<b>Avery MPI 8520 (PVC Free) Muurschildering behang - Papier peint Mural</b> Permanent lijm - Adhésif Permanent					
290µ 1,05 25		88297726		126,48	4,82
<b>Avery MPI 8826 High-Tack textielfilm - canvasafwerking - Film Textile High-Tack - Finition Canevas</b> Hi-Tack lijm - Adhésif Hi-Tack					
254µ 1,37 25		88297729		376,75	11,00

## Avery MPI 6021 ANTI-SLIP FLOOR MARKING

Dankzij de MPI 6021 antislipvloermarkeringsfilm is het nu eenvoudig om opmerkelijke grafische realisaties te produceren die op de vloer kunnen worden aangebracht. Dankzij het bedrukbare antislippoppervlak kunt u snel en eenvoudig tijdelijke campagnes maken, zonder laminering.

Grâce au film MPI 6021 Anti-Slip Floor Marking, il est désormais facile de produire de remarquables réalisations graphiques à appliquer au sol. Sa surface antidérapante imprimable vous permet de créer des campagnes temporaires rapidement et simplement, sans recourir à une lamination.

		Ref. Papyrus	Info	€/roll 	€/m <sup>2</sup> 
<b>Avery MPI 6021 Getextureerd mat wit - Blanc mat texturé</b> Verwijderbare lijm - Adhésif enlevable					
200µ 1,37 25 NEW		88316096		165,02	4,82

# Papyrus Viscom

Prijslijst / Liste de prix

Print Media: Solvent - UV - Latex - Hexis



PAPYRUS 

Your partner in Visual Communication



# Print Media: Solvent - UV - Latex - Hexis

<b>HEX'Press CAST Print Vinyl</b>	
Hexis THE190EVO cast wit glanzend - blanc brillant . . . . .	97
Hexis HX190WG2 cast wit glanzend - blanc brillant . . . . .	97
Hexis HXR101WG2 cast Wit glanzend - blanc brillant . . . . .	97
<b>CAST Print Vinyl</b>	
Hexis VCXR101WG1 cast Wit glanzend - blanc brillant . . . . .	97
Hexis VCSR101WG1 cast Wit glanzend - blanc brillant. . . . .	97
<b>Cast Laminates</b>	
<b>HEX'Press Polymeric Print Vinyls</b>	
Hexis HX200WG2 Polymeric Wit glanzend - blanc brillant 'LOW TACK' . . . . .	98
Hexis HX200NTWG2 Polymeric Wit glanzend - blanc brillant 'NORMAL TACK' . . . . .	98
Hexis HX201WG2 Polymeric Wit glanzend - blanc brillant . . . . .	98
<b>Polymeric Print Vinyls</b>	
Hexis V200WG1 Polymeric Wit glanzend - blanc brillant. . . . .	98
Hexis V200WM Polymeric Wit mat - blanc matte . . . . .	98
Hexis V201WG1 Polymeric Wit glanzend - blanc brillant. . . . .	98
Hexis V201TR1 Polymeric Translucent Matt - mat translucide . . . . .	98
Hexis V202CG1 Polymeric Transparant glanzend - transparent brillant. . . . .	98
Hexis V210WG1 Polymeric Wit glanzend - blanc brillant. . . . .	98
Hexis V211WG1 Polymeric Wit glanzend - blanc brillant. . . . .	98
Hexis VCSR201WG1 Polymeric Wit glanzend - blanc brillant. . . . .	99
Hexis VCSR200WG1 Polymeric Wit glanzend - blanc brillant. . . . .	99
Hexis VCXR201WG1 Polymeric Wit glanzend - blanc brillant . . . . .	99
<b>Polymeric Laminates</b>	
Hexis VCR750B Glanzend laminaat met versterkte lijmlaag - Laminat brillant adh, renforcé . . . . .	99
Hexis VCR750M Mat laminaat met versterkte lijmlaag - Laminat mat adh, renforcé . . . . .	99
<b>ETCHED GLASS Window Film</b>	
Hexis S5DEPM (V203EG) Polymeric Etched Glass Vinyl . . . . .	99
<b>Hybrid Print Vinyls</b>	
Hexis HX240WG2 Wit glanzend - blanc brillant HX Liner . . . . .	100
Hexis HX240WM2 Wit Mat - blanc Mat HX Liner . . . . .	100
Hexis V240WG1 Wit glanzend - blanc brillant PE Liner. . . . .	100
<b>HYBRID Laminates</b>	
<b>HEX'Press Monomeric Print Vinyls</b>	
Hexis HX3000WG2 Monomeric Vinyl wit glanzend - blanc brillant . . . . .	100
<b>Monomeric Print Vinyls - V300 serie</b>	
Hexis V300WG1 Monomeric wit glanzend - blanc brillant . . . . .	100
Hexis V301WG1 Monomeric wit glanzend - blanc brillant . . . . .	100
<b>Monomeric Print Vinyls - V300 serie (Vervolg - Suite)</b>	
Hexis V302CG1 Monomeric transparant glanzend - transparent brillant . . . . .	101
Hexis V362CG1 Monomeric transparant glanzend - transparent brillant . . . . .	101
Hexis V310WG1 Monomeric wit glanzend - blanc brilant . . . . .	101
Hexis V311WG1 Monomeric wit glanzend - blanc brillant . . . . .	101
Hexis VCSR301WG1 Monomeric wit glanzend - blanc brillant . . . . .	101
Hexis VCSR301WM1 Monomeric wit mat - blanc mat . . . . .	101
Hexis VCLEARCG1 Monomeric Ultra transparant glanzend - Transparent ultra clair brillant . . . . .	101
<b>Monomeric Print Vinyls - V3000 serie</b>	
Hexis V3000WG Monomeric wit glanzend - blanc brillant . . . . .	102
Hexis V3000WM Monomeric wit mat - blanc mat . . . . .	102
Hexis V3001WG Monomeric wit glanzend - blanc brillant . . . . .	102
Hexis V3001WM Monomeric wit mat - blanc matt . . . . .	102
Hexis V3100WG Monomeric wit glanzend - blanc brillant . . . . .	102
Hexis V3101WG Monomeric wit glanzend - blanc brillant . . . . .	102
<b>Monomeric Print Vinyls - Repostick</b>	
Hexis Repostick Monomeric wit mat - blanc mat. . . . .	103
<b>Monomeric Laminates</b>	
Hexis V700B Glanzend laminaat - Laminat brillant . . . . .	103
Hexis V700M Mat laminaat - Laminat mat . . . . .	103
Hexis V700S Satijn laminaat - Laminat satin . . . . .	103
<b>Free PVC self Adhésif</b>	
Hexis HX500WG2 Film Zonder PVC wit glanzend - Film sans PVC blanc brillant. . . . .	104

<b>Free PVC Laminates</b>	
Hexis PC500CG2 Glanzend laminaat - Laminat brillant . . . . .	.104
Hexis PC500M Mat laminaat - Laminat Mat . . . . .	.104
<b>Truck Banner Film</b>	
<b>Truck Banner Laminates</b>	
<b>Bilboard Paper</b>	
<b>Perforated Window Film Self Adhesive</b>	
Hexis MICRO2 Polymeric Microperforated Vinyl 68/32 . . . . .	.105
Hexis MICRO6 Monomeric Microperforated Vinyl 70/30 . . . . .	.105
<b>Laminates for Perforated Window Film</b>	
Hexis PC50MICP2 Gegoten PVC / PVC Coulé . . . . .	.105
Hexis PG836 Glanzend polyester / Polyester brillant. . . . .	.105
<b>Pre Pasted Wall Paper</b>	
<b>Sealing Tapes and Vernis for Perforated Window Films</b>	





## HEX'Press CAST Print Vinyl

Zelfklevende gegoten vervormbare vinyls, Eenvoudig aan te brengen vinyl dankzij de herpositioneerbare gestructureerde lijmlaag. Voor meer info: contacteer ons of raadpleeg onze technische datasheets en application guides.

Vinyles adhésifs coulés déformables. Facile à appliquer grâce à sa colle structurée et repositionnable, Pour de plus amples informations, contactez-nous ou consultez nos fiches techniques et fiches de pose.

				Ref. Papyrus	Info	€/roll 	€/m <sup>2</sup> 
--	--	--	--	-----------------	------	------------	----------------------

### Hexis THE190EVO cast wit glanzend - blanc brillant

Take Heat Easy® technology lijmlaag - Colle Take Heat Easy® technology à tack initial faible, repositionnable

50	1,37	45	2/4	88280234		727,64	11,80
	1,52	45	2/4	88280235		807,3	11,80

### Hexis HX190WG2 cast wit glanzend - blanc brillant

grijze permanent HEX'Press lijmlaag - colle grise permanent HEX'Press



50	1,37	45	10	88142745		699,07	11,34
	1,52	45	10	88152430		775,61	11,34

### Hexis HXR101WG2 cast Wit glanzend - blanc brillant

versterkte lijmlaag HEX'Press - colle renforcé HEX'Press



50	1,37	45	10	88239533		712,4613	11,56
----	------	----	----	----------	--	----------	-------

## CAST Print Vinyl

Zelfklevende gegoten vervormbare vinyls

Vinyles adhésifs coulés déformables

### Hexis VCXR101WG1 cast Wit glanzend - blanc brillant

transparante extra versterkte lijmlaag lijm - colle transparente super renforcé

50	1,37	45	10	88162151		724,24	11,75
----	------	----	----	----------	--	--------	-------

### Hexis VCSR101WG1 cast Wit glanzend - blanc brillant

transparante permanente lijm, hoge kleefkracht - PE Liner - colle transparente permanente, adhérence élevée - PE Liner

50	1,37	45	10	88103572		691,38	11,21
----	------	----	----	----------	--	--------	-------



## Cast Laminates

Zelfklevende gegoten vinylaminaten (transparant)

Films vinyle de pelliculage coulé adhésifs (transparent)

				Ref. Papyrus	Info	€/roll 	€/m <sup>2</sup> 
--	--	--	--	-----------------	------	------------	----------------------

### Hexis PC30G2 Glanzend 3D-Laminaat - Laminat 3D brillant

30	1,37	50		88103689		612,13	8,94
	1,52	50		88103690		679,15	8,94

### Hexis PC30M3 Mat 3D-Laminaat - Laminat 3D Mat

30	1,37	50		88103692		612,13	8,94
	1,52	50		88173977		679,15	8,94

### Hexis PC190G2 Glanzend 3D-Laminaat - Laminat 3D Brillant

50	1,37	50	5	88146144		685,53	10,01
	1,52	50	5	88152429		760,58	10,01

### Hexis PC190M3 Mat 3D-Laminaat - Laminat 3D Mat

50	1,37	50	5			685,79	10,01
	1,52	50	5	88231107		760,88	10,01



## HEX'Press Polymeric Print Vinyls

Polymeer gekalanderd zelfklevende vinyls Eenvoudig aan te brengen vinyl dankzij de herpositioneerbare gestructureerde lijmlaag. Voor meer info contacteer ons of raadpleeg onze technische datasheets en application guides.

Vinyles adhésifs calandrés polymère Facile à appliquer grâce à sa colle structurée et repositionnable. Pour de plus amples informations, contactez-nous ou consultez nos fiches techniques et fiches de pose.

				Ref. Papyrus	Info	€/roll 	€/m <sup>2</sup> 
--	--	--	--	-----------------	------	------------	----------------------

### Hexis HX200WG2 Polymeric Wit glanzend - blanc brillant 'LOW TACK'

grijze permanente lijm, herpositioneerbaar - colle grise permanente, repositionnable



70	1,37	45	8	88103573		491,92	7,98
	1,6	45	8	88103574		574,49	7,98

### Hexis HX200NTWG2 Polymeric Wit glanzend - blanc brillant 'NORMAL TACK'

grijze permanente lijm, herpositioneerbaar - colle grise permanente, repositionnable



70	1,37	45	8	88150447		491,92	7,98
	1,6	45	8			574,49	7,98

### Hexis HX201WG2 Polymeric Wit glanzend - blanc brillant

transparante permanente lijm, herpositioneerbaar - colle transparente permanente, repositionnable



70	1,37	45	8	88103575		491,92	7,98
----	------	----	---	----------	--	--------	------

## Polymeric Print Vinyls

Polymeer gekalanderde zelfklevende vinyl - PE Liner

Vinyles adhésifs calandrés polymère - PE Liner

### Hexis V200WG1 Polymeric Wit glanzend - blanc brillant

grijze permanente lijm - PE Liner - colle grise permanente - PE Liner

70	1,37	45	8	88103576		330,3	5,36
	1,6	45	8	88103577		385,75	5,36

### Hexis V200WM Polymeric Wit mat - blanc matte

grijze permanente lijm - PE Liner - colle grise permanente - PE Liner

70	1,37	45	8	88253291		330,3	5,36
	1,6	45	8			385,75	5,36

### Hexis V201WG1 Polymeric Wit glanzend - blanc brillant

transparante permanente lijm - PE Liner - colle transparente permanente - PE Liner

70	1,05	45	8	88152028		253,14	5,36
	1,37	45	8	88143453		330,30	5,36
	1,6	45	8	88143454		385,75	5,36

### Hexis V201TR1 Polymeric Translucent Matt - mat translucide

transparante permanente lijm - PE Liner - colle transparente permanente - PE Liner

70	1,37	45	5	88103578		375,83	6,10
----	------	----	---	----------	--	--------	------

### Hexis V202CG1 Polymeric Transparant glanzend - transparent brillant

transparante permanente lijm - PE Liner - colle transparente permanente - PE Liner

70	1,37	45	5	88103579		332,86	5,40
70	1,6	45	5	88103580		388,074	5,39

### Hexis V210WG1 Polymeric Wit glanzend - blanc brillant

zwarte afneembare lijm - PE Liner - colle noire détachable - PE Liner

70	1,37	45	0,5	88269123		332,86	5,40
	1,6	45	0,5			388,74	5,40

### Hexis V211WG1 Polymeric Wit glanzend - blanc brillant

transparante afneembare lijm - PE Liner - colle transparente détachable - PE Liner

70	1,37	45	0,5			332,86	5,40
	1,6	45	0,5			388,74	5,40



## Polymeric Print Vinyls (Vervolg - Suite)

Polymeer gekalanderde zelfklevende vinyl - PE Liner  
Vinyles adhésifs calandrés polymère - PE Liner

				Ref. Papyrus	Info	€/roll 	€/m <sup>2</sup> 
--	--	--	--	-----------------	------	------------	----------------------

### Hexis VCSR201WG1 Polymeric Wit glanzend - blanc brillant

transparante permanente lijm, hoge kleefkracht - PE Liner - colle transparente permanente, adhérence élevée - PE Liner

70	1,37	45	8	88103581		366,21	5,94
	1,6	45	8	88145608		427,69	5,94

### Hexis VCSR200WG1 Polymeric Wit glanzend - blanc brillant

grijze permanente lijm, hoge kleefkracht - PE Liner - colle grise permanente, adhérence élevée - PE Liner

70	1,37	45	8	88223800		366,04	5,94
----	------	----	---	----------	--	--------	------

### Hexis VCXR201WG1 Polymeric Wit glanzend - blanc brillant

transparante permanente lijm, extra hoge kleefkracht - PE Liner - colle transparente permanente, adhérence extra élevée - PE Liner

70	1,37	40	8	88200896		481,15	8,78
----	------	----	---	----------	--	--------	------

## Polymeric Laminates

Zelfklevende polymeer gekalanderde vinyl laminaten (transparant)  
Vinyles de pelliculage adhésifs calandrés polymère (transparent)

				Ref. Papyrus	Info	€/roll 	€/m <sup>2</sup> 
--	--	--	--	-----------------	------	------------	----------------------

### Hexis V750B Glanzend laminaat - Laminat brillant

70	1,05	50	5	88103704		285,65	5,44
	1,37	50	5	88103705		372,70	5,44
	1,6	50	5	88103706		435,26	5,44

### Hexis V750M Mat laminaat - Laminat mat

70	1,37	50	5	88103707		372,70	5,44
	1,6	50	5	88103708		435,26	5,44

### Hexis VCR750B Glanzend laminaat met versterkte lijmlaag - Laminat brillant adh, renforcé

Aanbevolen voor UV afdrukken - conseillé pour épreuves UV

70	1,37	50	5	88103737		452,51	6,61
	1,6	50	5			528,55	6,61

### Hexis VCR750M Mat laminaat met versterkte lijmlaag - Laminat mat adh, renforcé

Aanbevolen voor UV afdrukken - conseillé pour épreuves UV

70	1,37	50	5	88163109		452,44	6,60
	1,6	50	5	88165266		528,40	6,61

## ETCHED GLASS Window Film

Gezandstraald effect -  
Aspect dépoli mat

				Ref. Papyrus	Info	€/roll 	€/m <sup>2</sup> 
--	--	--	--	-----------------	------	------------	----------------------

### Hexis S5DEPM (V203EG) Polymeric Etched Glass Vinyl

Gezandstraald effect transparante permanente lijm PE Liner Effet sablé colle transparente permanente - Liner PE

80	1	30	5	88103429		194,10	6,47
	1,23	30	5	88103430		238,74	6,47
	1,52	30	5	88103431		295,03	6,47



## Hybrid Print Vinyls

Hybrid PVC zelfklevende vinyl -  
Vinyles adhésifs PVC Hybride

					Ref. Papyrus	Info	€/roll 	€/m <sup>2</sup> 
<b>Hexis HX240WG2 Wit glanzend - blanc brillant HX Liner</b> grijze permanente lijm, herpositioneerbaar - colle grise permanente, repositionnable								
70	1,37	45			88178647		272,57	4,42
<b>Hexis HX240WM2 Wit Mat - blanc Mat HX Liner</b> grijze permanente lijm, herpositioneerbaar - colle grise permanente, repositionnable								
70	1,37	45			88280237		272,86	4,43
<b>Hexis V240WG1 Wit glanzend - blanc brillant PE Liner</b> grijze permanente lijm, herpositioneerbaar - colle grise permanente, repositionnable								
70	1,05	45			88178781		170,57	3,61
	1,37	45			88178776		222,55	3,61
	1,6	45			88178779		259,91	3,61

## HYBRID Laminates

Zelfklevende gekalanderde hybride laminaten (transparant)  
Vinyles de pelliculage adhésifs calandrés hybride (transparent)

Hexis V740B Glanzend Laminaat - Laminat Brillant

70	1,05	50			88178790		185,15	3,53
	1,37	50			88178787		241,58	3,53
	1,6	50			88178784		282,13	3,53



## HEX'Press Monomeric Print Vinyls

Monomeer gekalanderde zelfklevende vinyls Eenvoudig aan te brengen vinyl dankzij de herpositioneerbare gestructureerde lijmlaag, Voor meer info; contacteer ons of raadpleeg onze technische datasheets en application guides.

Vinyles adhésifs calandrés monomère, Facile à appliquer grâce à sa colle structurée et repositionnable, Pour de plus amples informations, contactez-nous ou consultez nos fiches techniques et fiches de pose,

Hexis HX3000WG2 Monomeric Vinyl wit glanzend - blanc brillant  
grijze permanente lijm, herpositioneerbaar - colle grise permanente, repositionnable



100	1,37	45	4		88103594		218,06	3,54
	1,6	45	4		88103608		254,67	3,54

## Monomeric Print Vinyls - V300 serie

Monomeer gekalanderde zelfklevende vinyls - PE Liner  
Vinyles adhésifs calandrés monomère - PE Liner

Hexis V300WG1 Monomeric wit glanzend - blanc brillant  
grijze permanente lijm - colle grise permanente

100	1,05	45	4		88103593		119,84	2,54
	1,37	45	4		88103583		156,37	2,54
	1,6	45	4		88103584		182,62	2,54
<b>Hexis V301WG1 Monomeric wit glanzend - blanc brillant</b> transparante permanente lijm - colle transparente permanente								
100	1,37	45	4		88103587		156,37	2,54
	1,6	45	4				182,62	2,54

## Monomeric Print Vinyls - V300 serie (Vervolg - Suite)

Monomeer gekalanderde zelfklevende vinyls - PE Liner

Vinyles adhésifs calandrés monomère - PE Liner

				Ref. Papyrus	Info	€/roll 	€/m <sup>2</sup> 
<b>Hexis V302CG1 Monomeric transparant glanzend - transparent brillant</b> transparante permanente lijm - colle transparente permanente							
80	1,37	45	3	88103589		213,87	3,47
	1,6	45	3	88242809		249,77	3,47
<b>Hexis V362CG1 Monomeric transparant glanzend - transparent brillant</b> transparante verwijderbare lijm - colle transparente enlevable							
80	1,37	45	3			266,33	4,32
	1,6	45	3			311,04	4,32
<b>Hexis V310WG1 Monomeric wit glanzend - blanc brillant</b> zwarte afneembare lijm - colle noire détachable							
100	1,37	45	0,5	88103590		156,37	2,54
	1,6	45	0,5	88103591		182,62	2,54
<b>Hexis V311WG1 Monomeric wit glanzend - blanc brillant</b> transparante afneembare lijm - colle transparente détachable							
100	1,37	45	0,5	88103592		156,37	2,54
	1,6	45	0,5			182,62	2,54
<b>Hexis VCSR301WG1 Monomeric wit glanzend - blanc brillant</b> transparante permanente lijm - colle transparente permanente - hoge kleefkracht - PE Liner - adhérence super renforcée							
100	1,37	45	4	88111668		291,82	4,73
	1,6	45	4	88154668		337,09	4,68
<b>Hexis VCSR301WM1 Monomeric wit mat - blanc mat</b> transparante permanente lijm - colle transparente permanente - hoge kleefkracht - PE Liner - adhérence super renforcée							
100	1,37	45	4	88130500		291,82	4,73
<b>Hexis VCLEARCG1 Monomeric Ultra transparant glanzend - Transparent ultra clair brillant</b> transparante verwijderbare lijm - colle transparente enlevable							
80	1,27	30	3	88251660		256,86	6,74



## Monomeric Print Vinyls - V3000 serie

Monomeer gekalanderde zelfklevende vinyls - SK Liner,  
Vinyles adhésifs calandrés monomère - SK Liner

				Ref. Papyrus	Info		
						€/roll	€/m <sup>2</sup>
<b>Hexis V3000WG Monomeric wit glanzend - blanc brillant</b> grijze permanente lijm - colle grise permanente							
100	1,05	45	4	88103595		85,05	1,80
	1,37	45	4	88103596		110,97	1,80
	1,6	45	4	88103597		129,60	1,80
<b>Hexis V3000WM Monomeric wit mat - blanc mat</b> grijze permanente lijm - colle grise permanente							
100	1,05	45	4	88137932		97,94	2,07
	1,37	45	4	88103599		127,78	2,07
	1,6	45	4	88103600		149,24	2,07
<b>Hexis V3001WG Monomeric wit glanzend - blanc brillant</b> transparante permanente lijm - colle transparente permanente							
100	1,05	45	4			85,05	1,80
	1,37	45	4	88103601		110,97	1,80
	1,6	45	4	88103602		129,60	1,80
<b>Hexis V3001WM Monomeric wit mat - blanc matt</b> transparante permanente lijm - colle transparente permanente							
100	1,37	45	4	88146814		127,78	2,07
<b>Hexis V3100WG Monomeric wit glanzend - blanc brillant</b> zwarte afneembare lijm - colle noire détachable							
100	1,05	45	0,5			89,35	1,89
	1,37	45	0,5	88103603		116,57	1,89
	1,6	45	0,5	88103604		136,15	1,89
<b>Hexis V3101WG Monomeric wit glanzend - blanc brillant</b> transparante afneembare lijm - colle transparente détachable							
100	1,05	45	0,5			89,35	1,89
	1,37	45	0,5	88103605		116,57	1,89
	1,6	45	0,5	88103606		136,15	1,89



## Monomeric Print Vinyls - Repostick

Monomeer gekalanderde zelfklevende vinyls met verwijderbare lijm.  
Vinyles adhésifs calandrés monomère avec colle enlevable.

				Ref. Papyrus	Info	€/roll 	€/m <sup>2</sup> 
--	--	--	--	-----------------	------	------------	----------------------

**Hexis Repostick Monomeric wit mat - blanc mat**  
transparante verwijderbare lijm - colle transparente enlevable

180	1,37	50	4	88298429		223,05	3,26
	1,6	50	4	88298430		260,49	3,26

## Monomeric Laminates

Zelfklevende monomeer gekalanderde vinyl laminaten (transparant).  
Vinyles de pelliculage adhésifs calandrés monomère (transparent)

**Hexis V700B Glanzend laminaat - Laminat brillant**

Aanbevolen voor monomeervinyl, papier en waterbased media - Conseillé pour vinyle monomère, papier et media à base d'eau

80	1,05	50	3			221,71	4,22
	1,31	50	3			276,61	4,22
	1,37	50	3	88103698		289,32	4,22
	1,6	50	3	88103730		337,89	4,22

**Hexis V700M Mat laminaat - Laminat mat**

Aanbevolen voor monomeervinyl, papier en waterbased media - Conseillé pour vinyle monomère, papier et media à base d'eau

80	1,05	50	3	88103699		221,74	4,22
	1,31	50	3			276,61	4,22
	1,37	50	3	88103700		289,32	4,22
	1,6	50	3	88122091		337,89	4,22

**Hexis V700S Satijn laminaat - Laminat satin**

Aanbevolen voor monomeervinyl, papier en waterbased media - Conseillé pour vinyle monomère, papier et media à base d'eau

80	1,05	50	3	88103731		221,74	4,22
	1,31	50	3			276,61	4,22
	1,37	50	3	88103702		289,32	4,22
	1,6	50	3	88103703		337,89	4,22



## Free PVC self Adhésif

Car Wrapping Zonder PVC:HX500WG2 met PC500G2  
Car Wrapping sans pvc, utilisez HX500WG2 et PC500G2



Ref.  
Papyrus

Info



Hexis HX500WG2 Film Zonder PVC wit glanzend - Film sans PVC blanc brillant  
grijze permanent HEX'Press lijmlaag - colle grise permanent HEX'Press

50 1,52 45 4 1088,29 15,91

## Free PVC Laminates

Zelfklevende laminaten (transparant) Zonder PVC,  
Adhésif transparents sans PVC



Ref.  
Papyrus

Info



Hexis PC500CG2 Glanzend laminaat - Laminat brillant  
Polyurethane film geschikt voor HX500WG2 - Film Polyuréthane adapté pour le film HX500WG2



100 1,37 45 4 870,75 14,12

Hexis PC500M Mat laminaat - Laminat Mat  
Polyurethane film geschikt voor HX500WG2 - Film Polyuréthane adapté pour le film HX500WG2



50 1,52 50 4 1073,435 14,12



## Truck Banner Film

Voor toepassing op vrachtwagenzeilen  
Destiné à l'application sur bâche de camions

VTB901WG1 Zelfklevende gegoten vinyls - Vinyles adhésifs coulés

80 1,52 50 5 88316341 436,09 5,74

## Truck Banner Laminates

Voor koud lamineren bedrukbare gegoten films voor vrachtwagenzeilen VTB901WG1  
Destiné à la plastification à froid des films coulés imprimables pour bâches de camions VTB901WG1

Hexis PTB900 Glanzend laminaat - Laminat brillant

50 1,52 50 5 88316342 863,09 11,36





## Bilboard Paper



Ref.  
Papyrus

Info



### Hexis P135 White Coated Mat Paper

135g	1,37	60	NA	88104032		162,47	1,98
------	------	----	----	----------	--	--------	------



## Perforated Window Film Self Adhesive

Geperforeerde film geschikt voor decoratie raampartijen of autoglas, Films destinés à la décoration de vitrines ou vitres de véhicules en pose extérieure,

### Hexis MICRO2 Polymeric Microperforated Vinyl 68/32

Zwarte permanente lijm - Colle noir permanente

140	1	30	4	88103609		461,58	15,39
	1,37	30	4	88103610		632,37	15,39
	1,52	30	4	88124678		701,73	15,39

### Hexis MICRO6 Monomeric Microperforated Vinyl 70/30

Transparante permanente lijm - Colle transparent permanente



165	1,37	50	2	88103612		347,05	5,07
	1,52	50	2	88103613		385,04	5,07

## Laminates for Perforated Window Film

Zelfklevende vinyl en polyesterlaminaten specifiek voor toepassing op gaatjesfolie, Vinyles de pelliculage en PVC et polyester, spécifiques pour application sur des films microperforés



Ref.  
Papyrus

Info



### Hexis PC50MICP2 Gegoten PVC / PVC Coulé

Aabevolen voor MICRO2 en MICRO6 - Conseillé pour MICRO2 et MICRO6

50	1,37	30	2	88103693		551,99	13,43
	1,52	30	2	88124679		612,55	13,43

### Hexis PG836 Glanzend polyester / Polyester brillant

Aabevolen voor MICRO6 - Conseillé pour MICRO6

36	1,37	30	3	88103694		299,3	7,28
	1,52	30	3	88103695		332,06	7,28



## Pre Pasted Wall Paper

Pre Pasted Wall Paper Zelfklevend, PVC vrij behangpapier, Indoor gebruik. Zeer krasbestendig.  
 Revêtement mural constitué d'un papier sans PVC, intissé, préencollé, Application intérieur.  
 Bonne résistance aux rayures.

		Ref. Papyrus	Info	€/roll 	€/m <sup>2</sup> 
<b>Hexis WallPaper1 Pre-Pasted</b>					
330 1,118 51	2	88262110		318,33	5,58
1,27 51	2	88262113		361,61	5,58



## Sealing Tapes and Vernis for Perforated Window Films

Tapes en vernis ter bevordering van de hechting van PWF-films aan de randen of voor visuals die aan regelmatige reiniging onderworpen worden.

Tape et vernis pour améliorer l'adhérence des films microperforés sur les bords ou pour des visuals qui sont soumis à des nettoyages réguliers

		Ref. Papyrus	Info	€/roll 	€/m <sup>2</sup> 
<b>Hexis FPC50MICP2 Ultra-Clear self adhesive sealing tape for microperforated films</b>					
0,014 30	-	88166453		8,35	
<b>Hexis FPG836 Ultra-Clear self adhesive sealing tape for microperforated films</b>					
0,014 30	-			5,47	
<b>Hexis VR7077 Sealing varnish 250 ml</b>					
	-	88103682		13,04	
<b>Hexis SEALIT Sealing pen</b>					
	-	88103683		20,53	

# Papyrus Viscom

Prijslijst / Liste de prix

Print Media: Solvent - UV - Latex - Others



**PAPYRUS** 

Your partner in Visual Communication



# Print Media: Solvent - UV - Latex - Others

<b>Billboard Papers</b>	
Witte rug - Dos blanc . . . . .	.111
Metro City . . . . .	.111
Metro Expo . . . . .	.111
Metro Chic . . . . .	.111
Opti white back poster paper . . . . .	.111
Blauwe rug - Dos bleu . . . . .	.111
Metro Blue . . . . .	.111
Opti blue back poster paper . . . . .	.111
<b>Photo Paper</b>	
Kodak Premium Satin Photo Paper . . . . .	.111
Kodak Premium Glossy Photo Paper . . . . .	.111
<b>PVC Banners</b>	
Calendred PVC banners - Bâches PVC laminées . . . . .	.112
Opti PVC Frontlit Banner . . . . .	.112
Cast PVC banners - Bâches PVC coulées . . . . .	.112
Dickson JET 400 Frontlit Banner . . . . .	.112
Opti PVC Frontlit Banner . . . . .	.112
Dickson JET 550 Frontlit Banner . . . . .	.112
Dickson JET 520 Frontlit Banner - M1 gecertificeerd - certifié M1 . . . . .	.113
Opti PVC Frontlit Blockout Banner . . . . .	.113
Dickson LACOPAC Blockout Banner . . . . .	.113
PVC Free Banners	
Dickson JET 250 Evergreen Banner . . . . .	.113
Dickson JET UP Evergreen Banner . . . . .	.113
Dickson JET TEX Evergreen Banner . . . . .	.113
Dickson JET TEX DECO Evergreen Banner . . . . .	.114
Dickson JET UP BC Evergreen Banner . . . . .	.114
<b>Mesh Banners</b>	
Opti Mesh Banner . . . . .	.114
<b>Backlit Films</b>	
Opti Backlit Polyester Film . . . . .	.114
<b>Roll-Up, Pop-Up Films</b>	
Opti Premium Matt Polypropylene 'Roll-Up Paper' Film . . . . .	.115
Opti Ultimate Textured Roll-up 230 . . . . .	.115
Opti Roll-up Banner Film . . . . .	.115
Opti Premium Satin White Roll-UP Polyester Banner . . . . .	.115
Opti Ultimate Textured Pop-up 385 . . . . .	.115
Opti Supreme Pop-up 500µ . . . . .	.115
Opti Pop-up Banner Film . . . . .	.115
Dickson JET 250 Evergreen Banner . . . . .	.116
Dickson JET UP Evergreen Banner . . . . .	.116
Dickson JET TEX Evergreen Banner . . . . .	.116
Dickson JET TEX DECO Evergreen Banner . . . . .	.116
Dickson JET TEX COMFORT Evergreen Banner . . . . .	.116
Dickson JET UP BC Evergreen Banner . . . . .	.116
<b>Canvas</b>	
Opti Artist Canvas . . . . .	.117
Opti Classic Matt Canvas . . . . .	.117
Magic GFCVM Matte Canvas . . . . .	.117
Dickson JET TEX Evergreen Banner . . . . .	.117
<b>Wall Papers</b>	
Digimura 2.1 . . . . .	.118
Digimura 1.1 . . . . .	.118
Digimura AU . . . . .	.118
Digimura AG . . . . .	.118
Muramour . . . . .	.118
Adhesive Pastes , primer and tools . . . . .	.118
Dickson JET TEX Evergreen Banner . . . . .	.119
Dickson JET TEX WALL Evergreen Banner . . . . .	.119
Opti Self-adhesive polyester textile . . . . .	.119
<b>Polyester Films</b>	
Opti Clearview non Adhesive . . . . .	.119
Opti Silver Metallic Polyester Film . . . . .	.119
Opti Gold Metallic Polyester Film . . . . .	.119
<b>Self Adhesive Perforated Window Film (PWF)</b>	
Opti PWF Premium Vinyl 60/40 . . . . .	.120
Opti PWF Innova Vinyl 70/30 . . . . .	.120

## Laminates for Perforated Window Film

Opti Cast Laminate PWF . . . . .	.120
Opti Protect Polyester Laminate. . . . .	.120

## Non Adhesive Perforated Window Film (PWF)

Opti Panorama Film. . . . .	.120
Opti Panorama Tape . . . . .	.120

## Mounting Film and Tape

Stickybits Mount Film PET. . . . .	.120
Stickybits Optically Ultra ClearMount Film . . . . .	.120

## Sticking without Adhesive : Static - Special - Magnetic

Teslalex. . . . .	.121
Teslabase . . . . .	.121
Opti Easy Stick Mat . . . . .	.121
Opti White PVC Cling Film . . . . .	.121
Opti Clear PVC Cling Film. . . . .	.121
Yupo Tako White - UV. . . . .	.121
Yupo Tako White - (Eco)Solvent. . . . .	.121
Yupo Jelly . . . . .	.121
Itac White. . . . .	.121

## Floormarking films

Asphalt Walk U . . . . .	.122
LUMI Walk . . . . .	.122
TEX Walk . . . . .	.122
SPORT Walk. . . . .	.122
CAT Walk . . . . .	.122
CLEAR Walk. . . . .	.122
SOFT Walk . . . . .	.122

**Opti®**

## Billboard Papers

Reeks papiersoorten voor posters, blueback- en backlitoepassingen. - Gamme de papiers pour affiches, support dos bleu et applications avec rétroéclairage.

			Box Label	Ref. Papyrus	Info	€/roll	€/m²
--	--	--	-----------	--------------	------	--------	------

### Witte rug - Dos blanc

#### Metro City

150 g/m² gesatineerd papier geschikt voor zowel posters als backlight - Papier avec aspect satiné 150 g/m² utilisable pour les affiches et les applications avec rétroéclairage

150	1,372	50		88100567		87,81	1,28
	1,6	50		88100568		102,40	1,28

#### Metro Expo

Gesatineerd outdoor posterpapier 200g/m² - Papier affiche d'exterieur avec aspect satiné 200 g/m²

200	1,067	50		88103823		93,90	1,76
	1,27	50		88103815		111,76	1,76
	1,372	50		88100569		120,74	1,76
	1,6	50		88103816		140,80	1,76

#### Metro Chic

Semi-gloss coated papier 220g/m² - Papier couché semi-brillant 220g/m²

220	1,372	50		88134405		149,55	2,18
	1,6	50		88144776		174,40	2,18

#### Opti white back poster paper

Gesatineerd coated poster papier 150g/m², Aanbevolen voor latex, UV en hard solvent, Mild en eco solvent bedrukking mogelijk aan lagere printsnelheid, - Papier avec aspect satiné 150 g/m² - Conseillé pour latex, UV et solvant, Reduire la vitesse d'impression avec les encres eco et mild solvant,

150	1,27	100		88091766		96,52	0,76
	1,372	100		88105655		104,27	0,76
	1,6	100		88172097		121,60	0,76

### Blaauwe rug - Dos bleu

#### Metro Blue

130 g/m² gesatineerd blueback outdoor papier - Papier d'exterieur dos bleu avec aspect satiné 130 g/m²

130	1,372	50		88100565		75,46	1,10
-----	-------	----	--	----------	--	-------	------

#### Opti blue back poster paper

Gesatineerd blueback outdoor papier 115 g/m² - Papier d'exterieur dos bleu avec aspect satiné 115 g/m²

115	1,372	100		88110106		82,32	0,60
	1,6	100		88116678		96,00	0,60

**Opti® Kodak**

## Photo Paper

Hoogwaardig foto papiervoor prints van fotografische kwaliteit.

Papier photo de qualité supérieure pour des impressions de qualité photo.

			Box Label	Ref. Papyrus	Info	€/roll	€/m²
--	--	--	-----------	--------------	------	--------	------

#### Kodak Premium Satin Photo Paper

Gesatineerd foto papier 225 g/m² - Papier photo aspect satiné 225 g/m²

1,372	30,5		KPPS54	88167936		124,28	2,97
1,524	30,5		KPPS60	88167937		135,73	2,92

#### Kodak Premium Glossy Photo Paper

Glanzend foto papier 225 g/m² - Papier photo aspect brillant 225 g/m²

225	1,372	30,5	KPPG54	88167943		124,28	2,97
	1,524	30,5	KPPG60	88167944		135,73	2,92



## PVC Banners

Witte PVC banners  
Bâches en PVC blanc

			Box Label	Ref. Papyrus	Info	€/roll	€/m²
--	--	--	-----------	--------------	------	--------	------

### Calendred PVC banners - Bâches PVC laminées

#### Opti PVC Frontlit Banner

PVC Gelamineerde Banner - Bâche PVC laminée

340	1,1	50	E/FB3/110050/76/1	-		93,50	1,70
	1,372	50	E/FB3/137250/76/2	-		116,62	1,70
	1,6	50	E/FB3/160050/76/3	-		136,00	1,70
	2,5	50	E/FB3/250050/76/4	-		212,50	1,70
440	1,1	30	E/FB4/110050/76/1	88107836		69,30	2,10
	1,372	30	E/FB4/137250/76/2	88101663		86,44	2,10
	1,6	30	E/FB4/160050/76/3	88107998		92,16	1,92
	2,2	50	E/FB4/220050/76/4			211,20	1,92
440	M11,37	50	E/FB6/137250/76/2	88105514		226,05	3,30

			Box Label	Ref. Papyrus	Info	€/roll	€/m²
--	--	--	-----------	--------------	------	--------	------

### Cast PVC banners - Bâches PVC coulées

#### Dickson JET 400 Frontlit Banner

PVC Banner 370 g/m². Dankzij een nieuw techniek waarbij symmetrische enductie coating word aangebracht in de banner heeft de JET 400 het certificaat anti-curling. Dankzij het anti-curling certificaat is de JET 400 ook uitermate geschikt als economische oplossing voor displays en roll-up banners.

Bâche PVC 370 g/m². Suite à une amélioration technique qui permet de déposer des couches d'enduction symétriques entre l'endroit et l'envers de la toile, le jet 400 est dorénavant certifié 'anti-curling'. Cette certification fait que le jet 400 est aussi une solution économique pour les displays et roll-up.

370	1,06	50	JET400-42	88179711	-	197,69	3,73
	3,2	50	JET400-126	88103901		552,00	3,45

#### Opti PVC Frontlit Banner

Gecoatete Banner, B1 gecertificeerd - Best bedrukbare zijde is naar buiten gewikkeld - Bâche PVC Coulée certifié B1 - Côté le mieux adapté à l'impression enroulé vers l'extérieur

	1,1	50	E/FB5/110050/76/1	88247484		215,60	3,92
	1,372	50	E/FB5/137250/76/1	88247485		268,91	3,92
	1,6	50	E/FB5/160050/76/1	88247486		313,60	3,92
	2,15	30	S803-87	88105464	End of Stock	277,35	4,30
	2,5	50	E/FB5/250050/76/1	88247487		490,00	3,92

#### Dickson JET 550 Frontlit Banner

PVC Banner 560 g/m², Top kwaliteit. Europees product, hoge mechanische weerstand, snelle droogtijd. - Bâche PVC 560g/m² haute qualité origine européenne, haute résistance mécanique, temps de séchage rapide.

560	0,76	30	JET550-30	88103908		110,58	4,85
	1,06	30	JET550-42	88103910		154,23	4,85
	1,37	30	JET550-54	88103912		199,34	4,85
	1,52	30	JET550-60	88184354		221,16	4,85
	1,62	30	JET550-64	88103913		235,71	4,85
	2,5	30	JET550-100	88103906		333,75	4,45
	3,2	30	JET550-126	88103907		427,20	4,45





## PVC Banners (vervolg - suite)

Witte PVC banners  
Bâches en PVC blanc

			Box Label	Ref. Papyrus	Info	€/roll	€/m²
--	--	--	-----------	--------------	------	--------	------

### Dickson JET 520 Frontlit Banner - M1 gecertificeerd - certifié M1

PVC Banner M1 550 g/m². Top kwaliteit, Europees product, hoge mechanische weerstand, snelle droogtijd - Bâche PVC M1 550 g/m². Haute qualité, origine européenne, haute résistance mécanique, temps de séchage rapide.

550	1,06	30	JET520-42	88170275		198,75	6,25
	1,37	30	JET520-54	88103904		256,88	6,25
	1,62	30	JET520-64	88103905		303,75	6,25
	2,5	60	JET520-100	88170276		906,00	6,04
	3,2	60	JET520-126	88103902		1159,68	6,04

### Opti PVC Frontlit Blockout Banner

Gecoate Blockout Banner, B1 gecertificeerd - Bâche PVC Coulée certifié B1

	1,372	50	E/EB5/137250/76/1	88247488		215,40	3,14
	1,6	50	E/EB5/160050/76/1	88247489		251,20	3,14

### Dickson LACOPAC Blockout Banner

PVC Banner 680 g/m², brandvertragend M2/B1, recto/verso beprintbaar met zowel solvent, UV als Latex inktten. - Bâche PVC opaque enduite 680 g/m², ignifugé M2/B1

Imprimable recto/verso avec des encres solvant, UV ou Latex,

680	1,02	30	LACOPAC-40	88179713	-	238,07	7,78
	1,37	30	LACOPAC-54	88179714	-	319,76	7,78
	3,1	30	LACOPAC-122	88179716		723,54	7,78



## PVC Free Banners

Minder milieubelastende producten, PVC, ftalaat- en fosfaatvrij, Indoor en outdoor gebruik, Banners/sign/POS/wallcovering - Produits moins nuisibles à l'environnement, Sans PVC, phtalates, phosphates, Usage en intérieur et en extérieur. Banners/sign/POS/wallcovering

			Box Label	Ref. Papyrus	Info	€/roll	€/m²
--	--	--	-----------	--------------	------	--------	------

### Dickson JET 250 Evergreen Banner

Ecologische banner 220 g/m² uit het Evergreen gamma - Toile écologique 220 g/m² de la gamme EverGreen Fabrics, non ignifuge Imprimable 1 face avec des encres solvant, UV ou Latex.

220	1,02	50	JET250-40	88179720	End of Stock	283,56	5,56
	1,06	50	JET250-40	88247320	-	294,68	5,56
	3,2	60	JET250-122	88165690		1032,96	5,38

### Dickson JET UP Evergreen Banner

Ecologische banner 280 g/m² uit het Evergreen gamma, brandvertragend Toile écologique 280 g/m² de la gamme EverGreen Fabrics, ignifuge

Imprimable 1 face avec des encres solvant, UV ou Latex,

280	0,9	50	JETUP-35	88179722		306,00	6,80
	1,06	50	JETUP-40	88179723	-	360,40	6,80
	1,37	50	JETUP-54	88179724	-	465,80	6,80
	1,62	50	JETUP-64	88179727		550,80	6,80
	3,2	60	JETUP-122	88179730		1253,76	6,53

### Dickson JET TEX Evergreen Banner

Ecologische banner 270 g/m² uit het Evergreen gamma, brandvertragend Toile écologique 270g/m² de la gamme EverGreen Fabrics, ignifuge

Imprimable 1 face par impression numérique avec des encres solvant, Eco-solvant, UV ou Latex,

	1,06	50	JETTEX-39	88247316	-	406,51	7,67
	1,37	50	JETTEX-54	88179735	-	525,40	7,67
	1,62	50	JETTEX-64	88179736	-	621,27	7,67
	2,7	60	JETTEX-102	88247318	-	1210,14	7,47
	3,2	60	JETTEX-122	88247319	-	1434,24	7,47



## PVC Free Banners (vervolg - suite)

Minder milieubelastende producten, PVC, ftalaat- en fosfaatvrij, Indoor en outdoor gebruik, Banners/sign/POS/wallcovering - Produits moins nuisibles à l'environnement, Sans PVC, phtalates, phosphates, Usage en intérieur et en extérieur, Banners/sign/POS/wallcovering

			Box Label	Ref. Papyrus	Info	€/roll	€/m²
--	--	--	-----------	--------------	------	--------	------

### Dickson JET TEX DECO Evergreen Banner

Ecologische banner 270 g/m² uit het Evergreen gamma, brandvertragend - Toile écologique 270g/m² de la gamme EverGreen Fabrics, ignifuge M1

Imprimable 1 face par impression numérique avec des encres solvant, Eco-solvant, UV ou Latex,



270	1,06	50	JETTEXDECO-39	88179738		496,08	9,36
	3,2	60	JETTEXDECO-122	88179739		1745,28	9,09

### Dickson JET UP BC Evergreen Banner

Ecologische banner 330 g/m² uit het Evergreen gamma, brandvertragend M1/B1 met zwarte rugzijde - Toile écologique 330g/m² de la gamme EverGreen Fabrics, ignifugé M1/B1

Opaque, bicolore (endroit blanc / envers noir), imprimable 1 face avec des solvant, UV ou Latex,



330	0,9	50	JETUPBC-35	88179740		400,05	8,89
	1,06	50	JETUPBC-42	88179741	-	471,17	8,89
	1,37	50	JETUPBC-54	88179742		608,97	8,89
	3,2	60	JETUPBC-122	88179743	-	1633,92	8,51



## Opti®



## Mesh Banners

Polyester gaasdoek gecoat met PVC en van liner voorzien voor het printen  
Toile ouverte couchée de PVC et munie d'un liner pour l'impression

			Box Label	Ref. Papyrus	Info	€/roll	€/m²
--	--	--	-----------	--------------	------	--------	------

### Opti Mesh Banner

PVC Mesh banner met synthetische liner - Bedrukbare zijde aan binnenkant opgerold - Bâche perforée PVC avec liner synthétique - Face imprimable enroulée à l'intérieur



300	1,372	50	E/MB5/137250/76/1	88102851		235,98	3,44
	1,6	50	E/MB5/160050/76/1	88102852		275,20	3,44
	2,5	50	E/MB5/250050/76/1	88102850		430,00	3,44

## Backlit Films

Hoge kwaliteit polyesterfilm voor lichtbakken, Glad oppervlak met een vuilafstotende werking. Het weerstaat blootstelling aan UV-licht, vocht en temperatuurwisselingen.

Film polyester de haute qualité pour les enseignes lumineuses. Surface lisse, résistant à la poussière, rayons UV, humidité et variations de températures.

			Box Label	Ref. Papyrus	Info	€/roll	€/m²
--	--	--	-----------	--------------	------	--------	------

### Opti Backlit Polyester Film

Front Print 200µ backlit film niet zelfklevend - Backlit Film 200µ non adhésif

200	0,914	30	S608	88103983		164,52	6,00
	1,372	30	S608	88116904		246,96	6,00
	1,524	30	S608	88153830		274,32	6,00

**Opti®**

## Roll-Up, Pop-Up Films

Serie gladde en gestructureerde kunststoffen voor Roll-Up en Pop-Up toepassingen

Série de supports synthétiques lisses et structurés pour des applications Roll-Up et Pop-Up

		Box Label	Ref. Papyrus	Info	€/roll	€/m <sup>2</sup>
--	--	-----------	--------------	------	--------	------------------

### Opti Premium Matt Polypropylene 'Roll-Up Paper' Film

Witte achterkant - Dos blanc



180	0,914	50	S901	88091759	167,26	3,66
	1,067	50	S901	88091761	195,26	3,66
	1,27	50	S901	88091762	232,41	3,66
	1,524	50	S901	88091760	278,89	3,66

### Opti Ultimate Textured Roll-up 230

Premium roll-up film - grijze rug, 98% dekking. Gestructureerd vooroppervlak en glanzend witte anti-reflecterende kras en waterbestendig. Laminieren is niet nodig. Antistatische behandeling voorkomt het aantrekken van stof en uitglijden in de printer. Perfecte stijfheid en vlakheid. Film Roll-up Premium - dos gris, 98% d'opacité. Surface avant texturée et antireflet blanche brillante résistante aux rayures et à l'eau. Pas besoin de lamination. Le traitement antistatique évite d'attirer la poussière et de glisser dans l'imprimante.

Rigidité et planéité parfaite.



230	0,914	30	230STL-914	88312180	251,55	9,17
	1,27	30	230STL-1270	88312181	349,64	9,17

### Opti Roll-up Banner Film

205µ roll-up banner film met witte achterkant - Film roll-up 205µ avec dos blanc



205	0,914	20	S610	88190156	120,65	6,60
	1,067	20	S610	88107999	140,84	6,60
	1,27	20	S610	88100578	167,64	6,60

### Opti Premium Satin White Roll-UP Polyester Banner

Zilver grijs achterkant - Dos Gris Argenté



175	0,914	50	S614	88146371	294,31	6,44
	1,067	50	S614	88131239	343,57	6,44

### Opti Ultimate Textured Pop-up 385

Premium pop-up film - grijze rug, 98% dekking. Gestructureerd vooroppervlak en glanzend witte anti-reflecterende kras en waterbestendig. Laminieren is niet nodig. Antistatische behandeling voorkomt het aantrekken van stof en uitglijden in de printer. Perfecte stijfheid en vlakheid. - Film pop-up Premium - dos gris, 98% d'opacité. Surface avant texturée et antireflet blanche brillante résistante aux rayures et à l'eau. Pas besoin de lamination. Le traitement antistatique évite d'attirer la poussière et de glisser dans l'imprimante.

Rigidité et planéité parfaite.



385	0,914	20	385STL-914	88312182	234,56	12,83
	1,27	20	385STL-1270	88312183	325,91	12,83

### Opti Supreme Pop-up 500µ

Onverslaanbare prijs-kwaliteitverhouding - grijze dekking van 98%. Licht gestructureerd oppervlak. Krasbestendig, geen laminering nodig. De antistatische behandeling voorkomt dat stof wordt aangetrokken en in de printer glijdt. Stijfheid, perfecte vlakheid. - Rapport qualité-prix imbattable - dos gris 98% d'opacité. Surface légèrement texturée. Résistant aux rayures, pas besoin de lamination. Le traitement antistatique évite d'attirer la poussière et de glisser dans l'imprimante.

Rigidité, planéité parfaite.



500	0,914	30	500STVL-914	88312184	214,78	7,83
	1,27	30	500STVL-1270	88312185	298,44	7,83

### Opti Pop-up Banner Film

350µ pop-up banner film met witte achterkant - Film pop-up 350µ avec dos blanc



350	0,914	20	S611	88108708	146,24	8,00
	1,067	20	S611	88108709	170,72	8,00



## Roll-Up, Pop-Up Films (vervolg - suite)

Serie gladde en gestructureerde kunststoffen voor Roll-Up en Pop-Up toepassingen.

Série de supports synthétiques lisses et structurés pour des applications Roll-Up et Pop-Up.

			Box Label	Ref. Papyrus	Info	€/roll	€/m <sup>2</sup>
--	--	--	-----------	--------------	------	--------	------------------

### Dickson JET 250 Evergreen Banner

Ecologische banner 220 g/m<sup>2</sup> uit het Evergreen gamma - Toile écologique 220 g/m<sup>2</sup> de la gamme EverGreen Fabrics, non ignifuge  
Imprimable 1 face avec des encres solvant, UV ou Latex.



220	1,02	50	JET250-40	88179720	End of Stock	283,56	5,56
	1,06	50	JET250-40	88247320		294,68	5,56
	3,2	60	JET250-122	88165690		1032,96	5,38

### Dickson JET UP Evergreen Banner

Ecologische banner 280 g/m<sup>2</sup> uit het Evergreen gamma, brandvertragend. - Toile écologique 280 g/m<sup>2</sup> de la gamme EverGreen Fabrics, ignifuge

Imprimable 1 face avec des encres solvant, UV ou Latex.



280	0,9	50	JETUP-35	88179722		306,00	6,80
	1,06	50	JETUP-40	88179723	-	360,40	6,80
	1,37	50	JETUP-54	88179724	-	465,80	6,80
	1,62	50	JETUP-64	88179727		550,80	6,80
	3,2	60	JETUP-122	88179730		1253,76	6,53

### Dickson JET TEX Evergreen Banner

Ecologische banner 270 g/m<sup>2</sup> uit het Evergreen gamma, brandvertragend  
Toile écologique 270g/m<sup>2</sup> de la gamme EverGreen Fabrics, ignifuge

Imprimable 1 face par impression numérique avec des encres solvant, Eco-solvant, UV ou Latex.



	1,06	50	JETTEX-39	88247316	-	406,51	7,67
	1,37	50	JETTEX-54	88179735	-	525,40	7,67
	1,62	50	JETTEX-64	88179736	-	621,27	7,67
	2,7	60	JETTEX-102	88247318	-	1210,14	7,47

### Dickson JET TEX DECO Evergreen Banner

Ecologische banner 270 g/m<sup>2</sup> uit het Evergreen gamma, brandvertragend. - Toile écologique 270g/m<sup>2</sup> de la gamme EverGreen Fabrics, ignifuge M1

Imprimable 1 face par impression numérique avec des encres solvant, Eco-solvant, UV ou Latex.



270	1,06	50	JETTEXDECO-39	88179738		496,08	9,36
	3,2	60	JETTEXDECO-122	88179739		1745,28	9,09

### Dickson JET TEX COMFORT Evergreen Banner

Ecologische banner 390 g/m<sup>2</sup> uit het Evergreen gamma, brandvertragend  
Toile écologique 390g/m<sup>2</sup> de la gamme EverGreen Fabrics, ignifuge

Imprimable 1 face par impression numérique avec des encres solvant, Eco-solvant, UV ou Latex,



270	1,06	50	JETTEX-Comfort-39		NEW	553,85	10,45
	3,1	40	JETTEX-Comfort-122		NEW	1240,00	10,00

### Dickson JET UP BC Evergreen Banner

Ecologische banner 330 g/m<sup>2</sup> uit het Evergreen gamma, brandvertragend M1/B1 met zwarte rugzijde. - Toile écologique 330g/m<sup>2</sup> de la gamme EverGreen Fabrics, ignifugé M1/B1

Opaque, bicolore (endroit blanc / envers noir), imprimable 1 face avec des solvant, UV ou Latex,



330	0,9	50	JETUPBC-35	88179740		400,05	8,89
	1,06	50	JETUPBC-42	88179741	-	471,17	8,89
	1,37	50	JETUPBC-54	88179742		608,97	8,89
	3,2	60	JETUPBC-122	88179743	-	1633,92	8,51



## Canvas

			Box Label	Ref. Papyrus	Info	€/roll	€/m <sup>2</sup>
<b>Opti Artist Canvas</b> 100% Polyester Canvas - Canvas 100% Polyestère <span style="float: right;"> </span>							
260	1,067	30	S740	88184403		184,06	5,75
	1,372	30	S740	88111211	-	236,67	5,75
<b>Opti Classic Matt Canvas</b> Canvas 75% Katoen - 25% Polyester - Canvas 75% Cotton - 25% Polyester							
320	1,56	25		88100579		262,13	6,72
<b>Magic GFCVM Matte Canvas</b> Canvas mix katoen/polyester met een aangepaste coating die een superieur kleurbereik en resolutie mogelijk maakt - Canvas mix coton/polyester avec un couchage qui permet une densité de couleurs et résolution supérieure							
383μ	0,914	22,86		88103941		202,33	9,68
	1,27	22,86		88103942		281,13	9,68
	1,37	22,86		88103943		303,72	9,70
	1,524	22,86		88103944		337,37	9,68
<b>Dickson JET TEX Evergreen Banner</b> Ecologische banner 270 g/m <sup>2</sup> uit het Evergreen gamma, brandvertragend - Toile écologique 270g/m <sup>2</sup> de la gamme EverGreen Fabrics, ignifuge Imprimable 1 face par impression numérique avec des encres solvant, Eco-solvant, UV ou Latex. <span style="float: right;"> </span>							
	1,06	50	JETTEX-39	88247316	-	406,51	7,67
	1,37	50	JETTEX-54	88179735	-	525,40	7,67
	1,62	50	JETTEX-64	88179736	-	621,27	7,67
	2,7	60	JETTEX-102	88247318	-	1210,14	7,47
	3,2	60	JETTEX-122	88247319	-	1434,24	7,47



## Wall Papers

Duurzaam hoogkwalitatief behang, effen of met structuur met als basis 60 g/m<sup>2</sup> polyester non woven en PVC-coating 290 g/m<sup>2</sup> (Digimura 2.1) of 240 g/m<sup>2</sup> (Digimura 1.1)g 290 g/m<sup>2</sup>

Papier peint durable et très qualitatif, Lisse ou structuré, sur base d'un non-tissé polyester 60 g/m<sup>2</sup>, couvert par un couchage PVC 290 g/m<sup>2</sup> (Digimura 2.1) ou 240 g/m<sup>2</sup> (Digimura 1.1)

			Box Label	Ref. Papyrus	Info	€/roll	€/m <sup>2</sup>
<b>Digimura 2.1</b>							
350	1,3	30	Smooth	88103893		324,87	8,33
	1,3	30	Tactile	88103892		480,87	12,33
	1,3	30	Dune	#		480,87	12,33
	1,3	30	Rude	#		480,87	12,33
	1,3	30	Façade	#		480,87	12,33
	1,3	30	Silk	#		480,87	12,33
<b>Digimura 1.1</b>							
300	1,3	30	Tactile	88154261	-	246,87	6,33
	1,3	30	Brut	88141866	-	246,87	6,33
	1,3	30	Stucco	#		246,87	6,33
	1,3	30	Linea	88130540	-	246,87	6,33
	1,3	30	Fino	#		246,87	6,33
	1,3	30	Pucker	#		246,87	6,33
<b>Digimura AU</b>							
350	1,28	30	Smooth			947,33	24,67
<b>Digimura AG</b>							
350	1,28	30	Smooth			947,33	24,67
<b>Muramour</b>							
300	1,3	30	Sable	88103881	-	143,13	3,67
	1,3	30	Lisse	88103965	-	143,13	3,67
	1,3	30	Lin	88275912	-	143,13	3,67
	1,3	30	Dune	#		143,13	3,67
	1,3	30	Japon	#		143,13	3,67
	1,3	30	Antico	#		143,13	3,67
<b>Adhesive Pastes , primer and tools</b>							
Murabond Easystrip 5kg (20m <sup>2</sup> )				88103891		33,33	
Murabond Heavy 10kg (50m <sup>2</sup> )						70,00	
Murabond Seales Surface 5kg (30m <sup>2</sup> )						75,00	
Murabond Light 10kg (70m <sup>2</sup> )				88105411		46,67	
Murabond Primer 2,5kg (80m <sup>2</sup> )						23,33	
Anti scratch spatula						40,00	
Overlap and Trim protection strip						14,00	
Box-base for Digimura RP (10-pack)						66,67	



## Wall Papers (Vervolg - Suite)

			Box Label	Ref. Papyrus	Info	€/roll	€/m <sup>2</sup>
--	--	--	-----------	--------------	------	--------	------------------

### Dickson JET TEX Evergreen Banner

Ecologische banner 270 g/m<sup>2</sup> uit het Evergreen gamma, brandvertragend. - Toile écologique 270g/m<sup>2</sup> de la gamme EverGreen Fabrics, ignifuge

Imprimable 1 face par impression numérique avec des encres solvant, Eco-solvant, UV ou Latex.



1,06	50	JETTEX-39	88247316	-	406,51	7,67
1,37	50	JETTEX-54	88179735	-	525,40	7,67
1,62	50	JETTEX-64	88179736	-	621,27	7,67
2,7	60	JETTEX-102	88247318	-	1210,14	7,47
3,2	60	JETTEX-122	88247319	-	1434,24	7,47

### Dickson JET TEX WALL Evergreen Banner

Ecologische banner 300 g/m<sup>2</sup> uit het Evergreen gamma, brandvertragend

Toile écologique 300g/m<sup>2</sup> de la gamme EverGreen Fabrics, ignifuge

Imprimable 1 face par impression numérique avec des encres solvant, Eco-solvant, UV ou Latex,



270	1,02	50	JETTEX-WALL-39	NEW	558,45	10,95
-----	------	----	----------------	-----	--------	-------

### Opti Self-adhesive polyester textile

Zelfklevend polyester, textiellook. - Polyester adhésif, aspect textile.



210	1,067	30	S902	88140541	-	282,65	8,83
	1,27	30	S902	88129723		336,42	8,83
	1,37	30	S902	88162577	-	362,91	8,83
	1,524	30	S902	88147590	-	403,71	8,83

## Polyester Films

Polyester Film voor latex, solvant en UV inkjetprinter

Support Polyester pour imprimante jet d'encre Latex, Solvant et UV

			Box Label	Ref. Papyrus	Info	€/roll	€/m <sup>2</sup>
--	--	--	-----------	--------------	------	--------	------------------

### Opti Clearview non Adhesive

Non Adhesive - Glasheldere polyesterfilm - 100% waterbestendig - Hoogglans coating. Antistatische achtercoating vermijdt het aantrekken van stof en uitglijden in de printer - Film polyester transparent non Adhésif - 100% résistant à l'eau.

Revêtement brillant. Le revêtement arrière antistatique évite d'attirer la poussière et de glisser dans l'imprimante



142	1,372	30	142SGC-1372	88312177		219,56	5,33
-----	-------	----	-------------	----------	--	--------	------

### Opti Silver Metallic Polyester Film

Glanzend zilver, enkelzijdig. Zeer egaal uitzicht, bijna spiegeleffect. Permanente lijm met hoge hechting.

Toepassing: Print and Cut. Corrosievrij voor duurzaamheid tot 3 jaar buiten zonder verkleuring.

Film argenté brillant simple face pour la lamination sur panneau rigide type « Dibond ». Finition très lisse, proche de l'effet miroir.

Adhésif à haute adhérence permanente. Peut être coupé et échenillé.

Sans corrosion ni décoloration pour une durabilité en extérieur jusqu'à 3 ans.



76	1,372	45,7	076SSI	88312178		530,96	8,47
----	-------	------	--------	----------	--	--------	------

### Opti Gold Metallic Polyester Film

Glanzend goud, enkelzijdig. Zeer egaal uitzicht, bijna spiegeleffect. Permanente lijm met hoge hechting. Toepassing: Print and Cut. Corrosievrij voor duurzaamheid tot 1 jaar buiten zonder verkleuring.

Film doré brillant simple face pour la lamination sur panneau rigide type « Dibond ». Finition très lisse, proche de l'effet miroir. Adhésif à haute adhérence permanente. Peut être coupé et échenillé.

Sans corrosion ni décoloration pour une durabilité en extérieur jusqu'à 3 ans.



76	1,372	45,7	076SGO	88312179		530,96	8,47
----	-------	------	--------	----------	--	--------	------

**Opti®**

## Self Adhesive Perforated Window Film (PWF)

Gekalanderde polymeervinyl  
Vinyle polymère calandré

	Box Label	Ref. Papyrus	Info	€/roll	€/m <sup>2</sup>
<b>Opti PWF Premium Vinyl 60/40</b> Vlakke oppervlakken. - Pour surfaces plates.					
145 1,372 25		88105478		617,40	18,00
<b>Opti PWF Innova Vinyl 70/30</b> -					
145 1,372 50		88105502		731,96	10,67

## Laminates for Perforated Window Film

### Opti Cast Laminate PWF

Voor vlakke en lichtgebogen oppervlakken in combinatie met PWF. - Pour applications planes et légèrement courbées en combinaison avec du PWF.

50 1,372 10		88105474		134,73	9,82
1,372 50	LAM0007	88105412		617,40	9,00
1,52 50				684,00	9,00

### Opti Protect Polyester Laminate

Polyester laminaat voor PWF op vlakke ondergrond. - Laminat polyester pour application sur PWF sur surfaces planes.

50 1,372 50	LAM0011	88105413		468,54	6,83
-------------	---------	----------	--	--------	------

## Non Adhesive Perforated Window Film (PWF)

### Opti Panorama Film

Op te kleven op binnenzijde ramen met behulp van Opti Panorama Tape. - A fixer à l'interieur des vitres à l'aide du Opti Panorama Tape.

200 1,372 25	1530	88105475		577,27	16,83
--------------	------	----------	--	--------	-------

### Opti Panorama Tape

Optische heldere dubbelzijdig tape. - Tape adhésif double face transparent ultra clair.

24 0,025 61	TAPE001			36,67	
-------------	---------	--	--	-------	--

**STICKYBITS**  
PROTECTING YOUR IMAGE

## Mounting Film and Tape

	Box Label	Ref. Papyrus	Info	€/roll	€/m <sup>2</sup>
<b>Stickybits Mount Film PET</b> -					
25 1,04 50	LAMMF104050	88103725		133,64	2,57
1,3 50	LAMMF130050	88103714		167,05	2,57
1,53 50	LAMMF153050	88103726		196,61	2,57
<b>Stickybits Optically Ultra ClearMount Film</b> -					
25 1,04 50	LAMOPT104050	88236220		312,00	6,00
1,3 50	LAMOPT130050			390,00	6,00
1,53 50	LAMOPT153050	88236223		411,57	5,38





## Sticking without Adhesive : Static - Special - Magnetic

Films die zonder lijm hechten op gladde oppervlakken, enkel bestemd voor binnengebruik  
Films qui adhèrent sans adhésif sur surfaces lisses, uniquement pour usage en intérieur











































			Box Label	Ref. Papyrus	Info	€/roll	€/m <sup>2</sup>
<b>Teslaflex</b> Ijzerhoudende witte beprintbare polyester film. - Film polyester blanc imprimable qui contient du fer. <span style="float: right;"> </span>							
340	1,27	50		88171065		635,00	10,00
	1,524	50		88171063		762,00	10,00
<b>Teslabase</b> Bruine zelfklevende magneetfolie waar Teslaflex eenvoudig op aan te brengen is. - Film magnétique adhésif brun sur lequel le Teslaflex est facile à monter.							
900	0,62	15		88137472		97,65	10,50
	1	15		88137751		157,50	10,50
<b>Opti Easy Stick Mat</b> Monomeer vinyl met dot adhesie coating voor eenvoudig aanbrengen en verwijderen zonder lijmresten - Film Vinyle Monomère Adhésif pour pose facile sur des surfaces lisses. Repositionnement et enlèvement facile sans résidus de colle.							
100μ	1,372	50		88177599		299,10	4,36
	1,524	50				332,23	4,36
<b>Opti White PVC Cling Film</b> Hoogwaardige PVC film, statisch hechtend. - Film de PVC de haute qualité adhérent par effet statique. <span style="float: right;"> </span>							
150	1,372	25	S304	88100958		198,94	5,80
<b>Opti Clear PVC Cling Film</b> Hoogwaardige PVC film, statisch hechtend. - Film de PVC de haute qualité adhérent par effet statique. <span style="float: right;"> </span>							
150	1,372	25	S303	88100957		198,94	5,80
<b>Yupo Tako White - UV</b> Witte polyprop film uitgerust met microscopische zuignapjes bestemd voor binnengebruik. Film polypropylène muni de micro ventouses pour usage intérieur. <span style="float: right;"> </span>							
190	1,27	20	XAD1069	88104565		220,22	8,67
<b>Yupo Tako White - (Eco)Solvent</b> Witte polypropfilm uitgerust met microscopische zuignapjes bestemd voor binnengebruik. Film polypropylène muni de micro ventouses pour usage intérieur. <span style="float: right;"> </span>							
245μ	1,27	20	XAD1082	88150122		302,26	11,90
<b>Yupo Jelly</b> Transparante film uitgerust met microscopische zuignapjes bestemd voor binnengebruik op glas. Film transparent muni de micro ventouses pour usage intérieur sur des vitres. <span style="float: right;"> </span>							
170	1,27	20	XAD1068	88114162		300,23	11,82
<b>Itac White</b> Zelfklevende film voor eenvoudige applicatie op gladde oppervlakken. Herpositioneerbaar en verwijderbaar zonder lijmresten. Film Vinyle Adhésif pour pose facile sur des surfaces lisses, Repositionnement et enlèvement facile sans résidus de colle. <span style="float: right;"> </span>							
170μ	1,37	50		88196095		486,35	7,10



## Floormarking films

Zelfklevende films voor vloermarkering die niet gelamineerd moeten en kunnen worden (tenzij met een vloeibaar laminaat, wat de levensduur kan verlengen).

Films adhésifs pour marquage au sol, qui ne doivent pas être laminés (sauf laminat liquide qui peut prolonger la durée de vie).

  	Box Label	Ref. Papyrus	Info	€/roll 	€/m <sup>2</sup> 
<b>Asphalt Walk U</b> Compatibel met UV en Latex inkten. Zelfklevende witte film op basis van aluminium en anti-sliplaag in polyurethaan, sterk klevend op basis van rubberlijm, licht vervormbaar, Geschikt voor buitengebruik op ruwe oppervlakken als asfalt, bitume, beton, klinkers, niet geschikt voor toepassingen op natuursteen. Compatible UV et Latex. Film blanc autocollant sur base aluminium et couché antidérapant en polyuréthane, adhésif à forte adhérence, base caoutchouc, le film s'adapte et se moule sur le support, Convient pour usage externe sur des surfaces rugueuses comme l'asphalte, bitume, béton, pavés mais pas sur des pierres naturelles.   					
390µ 1,22 30,48	Floor01-U	88216306		1963,40	52,80
Bechikbaar door lopende meter - Disponible au mètre courant: 64,42€/m.					
<b>TAR Walk = StarFilm + StarLam</b> PET Vinyl voor gladde en gepolijste ondergrond zoals marmer, Garantie alleen van toepassing in combinatie met het Star Laminaat, - Vinyle PET pour des surfaces lisse comme marbre, Garantie seulement applicable en cas d'utilisation de Lamination Star,    					
1,372 30,48	StarFilm01	#		404,39	9,67
1,372 30,48	StarLam01	#		172,71	4,13
<b>ATHLETIC Walk = AthleticFilm + AthleticLam</b> PET Vinyl voor indoor toepassingen op gladde sportvloeren. Garantie alleen van toepassing in combinatie met het Athletic Laminaat. - Vinyle PET pour des applications indoor sur des sol de sport lisse, Garantie seulement applicable en cas d'utilisation de Lamination Athletic.    					
1,372 30,48	AthleticFilm01	#		384,73	9,20
1,372 30,48	AthleticLam01	#		172,71	4,13
<b>LUMI Walk</b> Voor indoor veiligheids toepassingen met 'night and day' zichtbaarheid. Pour des applications de sécurité intérieur avec visibilité 'night and day'. 					
0,686 30,48	Lumi01	#		1196,01	57,20
<b>TEX Walk</b> Witte zelfklevende film voor binnengebruik, vooral tapijten en muren, Korte termijn toepassingen. Film blanc adhésif et structuré pour application intérieure sur des tapis et murs, Applications courte durée.     					
1,22 25	Tex01	88162425		445,30	14,60
1,22 50	Tex01			890,60	14,60
<b>SPORT Walk</b> Witte zelfklevende film voor binnengebruik met gestructureerd ruw oppervlak. Ook geschikt voor kortstondige (max 1 week) toepassingen buiten. Film blanc adhésif et structuré pour application intérieure ou de courte durée (1 semaine max,) à l'extérieur.   					
1,3 30,48	Sport01	#		784,56	19,80
<b>CAT Walk</b> Witte zelfklevende film voor binnengebruik met gestructureerd ruw oppervlak. Ook geschikt voor kortstondige (max 1 week) toepassingen buiten. Film blanc adhésif et structuré pour application intérieure ou de courte durée (1 semaine max,) à l'extérieur.   					
1,3 30,48	Cat01	#		726,31	18,33
<b>CLEAR Walk</b> Transparante zelfklevende film voor binnengebruik met gestructureerd ruw oppervlak. Ook geschikt voor kortstondige (max 1 week) toepassingen buiten. Film transparent adhésif et structuré pour application intérieure ou de courte durée (1 semaine max,) à l'extérieur.   					
1,3 30,48	Clear01	#		726,31	18,33
<b>SOFT Walk</b> Witte, niet zelfklevende geweven tapijt die enkel in UV bedrukbaar is en zowel binnen als buiten inzetbaar is - Structure, blanc, non adhésif, ressemble à un tapis doux et convient pour applications en intérieur et en extérieur. 					
1,524 25	Soft10	#		548,64	14,40
1,524 5	Soft20	#		180,37	23,67

# Papyrus Viscom

Prijslijst / Liste de prix  
Print Media: Waterbased



**PAPYRUS**   
Your partner in Visual Communication



# Waterbased Print Media

<b>PPC</b>	
OPTI PPC FSC . . . . .	127
OPTI PPC bulkpacked FSC . . . . .	127
OPTI PPC Blueback . . . . .	127
<b>Transparent Uncoated Inkjet Paper</b>	
Opti Uncoated. . . . .	127
<b>Uncoated Inkjet Paper</b>	
Opti Uncoated Paper . . . . .	128
<b>Coated Inkjet Paper</b>	
Opti Matt Coated Paper 90g . . . . .	128
Opti Matt Coated Paper 120g . . . . .	128
Opti Bright Matt Coated Poster Paper 160g. . . . .	129
Opti Barrier Coated Matt 180g . . . . .	129
Opti Power Paper 140g . . . . .	129
Opti Coloured Poster Paper 100g . . . . .	129
Opti Jet Fire Proof . . . . .	129
<b>Photo Coated Inkjet Paper</b>	
Opti Photo Paper Gloss 200g - (Master Photo Paper Gloss) . . . . .	130
Opti Photo Paper Semi-Gloss 200g - (Master Photo Paper Satin). . . . .	130
Opti Instant Dry Photo Paper Gloss 190 . . . . .	130
Opti Instant Dry Photo Paper Semi-Gloss 190 - (Satin). . . . .	130
Opti Photo Coated Proofing Semi-Gloss 190g . . . . .	130
<b>Photo Coated Inkjet Paper (Vervolg - Suite)</b>	
Opti Photo Coated Proofing Semi-Gloss 250g . . . . .	131
Kodak Rapid Dry Photo Glossy Paper 190g . . . . .	131
Kodak Rapid Dry Photo Satin Paper 190g . . . . .	131
Kodak Premium Rapid Dry Photo Glossy Paper 255g . . . . .	131
Kodak Premium Rapid Dry Photo Lustre Paper 255g. . . . .	131
<b>Canvas</b>	
Opti Canvas Matt Universal Textile. . . . .	132
Opti Polyester Canvas . . . . .	132
<b>Roll-Up / Pop-up</b>	
Opti Roll-Up . . . . .	132
Opti Pop-Up . . . . .	132
<b>Scrim Banner Vinyl</b>	
Kodak Water-Resistant Scrim Banner. . . . .	133
Opti Premium Scrim Banner . . . . .	133
Opti Scrim Banner Matt . . . . .	133
<b>Backlit Films</b>	
Opti Polyester Front Print Backlit Film 170µ . . . . .	133
Kodak Universal Front Print Backlit Film 8mil. . . . .	133
<b>Self Adhesive Vinyl</b>	
Opti Mat Stretch Vinyl. . . . .	134
Hexis V890 Matt Vinyl - Pigment. . . . .	134
<b>Self Adhesive Polyester Textile</b>	
Kodak PHOTO TEX Self Adhesive Polyester Textile . . . . .	134
<b>Wall Covering</b>	
Mural Pro Wall Covering. . . . .	135
<b>Magnetic Products</b>	
Teslaflex IJ Waterbased. . . . .	135
Teslabase Adhesive Magnetic . . . . .	135

## Fine Art Paper

Hahnemühle Photo Rag . . . . .	136
Hahnemühle Photo Rag Ultra Smooth . . . . .	136
Hahnemühle Bamboo . . . . .	136
Hahnemühle Photo Rag Ultra Bright White . . . . .	136
Hahnemühle William Turner . . . . .	136
Hahnemühle German Etching . . . . .	137
Hahnemühle Photo Rag Baryta . . . . .	137
Hahnemühle Photo Rag Pearl . . . . .	137
Hahnemühle Fine Art Baryta . . . . .	137
Hahnemühle Fine Art Pearl . . . . .	137

## Spray, Vernis

Hahnemühle Protective Spray . . . . .	138
Hahnemühle Vernis . . . . .	138

## Inkjet Sublimation Transfert Paper

Sublimation Paper . . . . .	138
-----------------------------	-----



# Opti®



## PPC

Ongestreeken wit en gekleurd papier op rol voor het printen van teksten, grafieken en beelden in kleur (kleurenkopie, laser en tonerpearl) Papier zit los op 3"/7,6 cm kern - Laser, Kip en OCE Colorwave

Papier blanc et de couleurs non couché en bobine pour l'impression de textes, graphiques et d'images en couleurs (copie, laser couleurs et tonerpearl) Le papier n'est pas attaché au mandrin 3"/7,6 cm - Laser, Kip et OCE Colorwave

			Box Label	Ref. Papyrus	€/roll	
--	--	--	-----------	--------------	--------	--

### OPTI PPC FSC

Verpakt in dozen  
Emballés dans des boîtes



75 Gr.	0,297	175	Opti Uncoated PPC 75g FSC 0,297 x 175m	88091414	-	12,53	0,24
	0,42	175	Opti Uncoated PPC 75g FSC 0,420 x 175m	88091415	-	17,73	0,24
	0,594	175	Opti Uncoated PPC 75g FSC 0,594 x 175m	88091416	-	24,73	0,24
	0,62	175	Opti Uncoated PPC 75g FSC 0,620 x 175m	88091417	-	25,8	0,24
	0,841	175	Opti Uncoated PPC 75g FSC 0,841 x 175m	88091418	-	35	0,24
	0,914	175	Opti Uncoated PPC 75g FSC 0,914 x 175m	88091419	-	38,03	0,24
115 Gr.	0,841	100	Opti Uncoated PPC 115g FSC 0,841 x 100m	88091426	-	33,38	0,4
	0,914	100	Opti Uncoated PPC 115g FSC 0,914 x 100m	88091425	-	36,28	0,4
160 Gr.	0,841	90	Opti Uncoated PPC 160g FSC 0,841 x 90m	88101676		60,4	0,8
	0,914	90	Opti Uncoated PPC 160g FSC 0,914 x 90m	88101677	-	66,99	0,81

### OPTI PPC bulkpacked FSC

28 bob/pal rechtopstaand onverpakt maar individueel ingesealed  
28 rol/pal debout mais emballé individuellement sous plastique



75 Gr.	0,594	175	Opti Uncoated PPC 75g FSC 0,594 x 175m	88091431	-	21,11	0,2
	0,841	175	Opti Uncoated PPC 75g FSC 0,841 x 175m	88091430	-	29,89	0,2
	0,914	175	Opti Uncoated PPC 75g FSC 0,914 x 175m	88091432	-	32,49	0,2

### OPTI PPC Blueback

Blueback affichepapier voor tonerpearl toestellen (Colorwave, Kip)  
Papier affiche Blueback pour applications sur imprimantes tonerpearl (Colorwave, Kip)

115 Gr.	0,841	100	Opti Bluebacked PPC 115g 0,841 x 100m	88132528	-	57,69	0,69
	0,914	100	Opti Bluebacked PPC 115g 0,914 x 100m	88132542	-	62,73	0,69
	1,067	100	Opti Bluebacked PPC 115g 1,067 x 100m	88132544	-	73,22	0,69



# Opti®



## Transparent Uncoated Inkjet Paper

Ongecoat papier, transparant (kalkaspect)  
Geschikt voor lijnwerk of full-color doch met lage kleurdensiteit - 720 DPI  
Papier non couché, transparent (aspect calque)  
Convient pour travaux filiaires ou à faible densité de couleurs - 720 DPI

			Box Label	Ref. Papyrus	€/roll	
--	--	--	-----------	--------------	--------	--

### Opti Uncoated

Opti Uncoated IJ TP 90g



90 Gr.	0,914	45	Opti Uncoated IJ TP 90g 0,914 x 45m	88103836	-	33,32	0,81
--------	-------	----	-------------------------------------	----------	---	-------	------



# Opti®



## Uncoated Inkjet Paper

Ongecoat papier, wit - Geschikt voor lijnwerk of full-color doch met lage kleurdensiteit - 720 DPI  
Papier non couché, blanc - Convient pour travaux filiaires ou à faible densité de couleurs - 720 DPI

### Opti Uncoated Paper

(Opaque Bond Paper-1569)



80 Gr.	0,61	50	Opti Uncoated Paper 80g 0,610 x 50m	88090827	-	11,34	0,37
	0,61	90	Opti Uncoated Paper 80g 0,610 x 90m	88090823	-	18,71	0,34
	0,841	50	Opti Uncoated Paper 80g 0,841 x 50m	88090826	-	13,94	0,33
	0,841	90	Opti Uncoated Paper 80g 0,841 x 90m	88090828	-	23,31	0,31
	0,914	50	Opti Uncoated Paper 80g 0,914 x 50m	88090824	-	15,11	0,33
	0,914	90	Opti Uncoated Paper 80g 0,914 x 90m	88090825	-	25,77	0,31
	1,067	50	Opti Uncoated Paper 80g 1,067 x 50m	88160081	-	20,89	0,39

(CAD Final Paper-1570)



90 Gr.	0,594	90	Opti Uncoated Paper 90g 0,594 x 90m	88087967	-	20,29	0,38
	0,61	50	Opti Uncoated Paper 90g 0,610 x 50m	88087965	-	12,29	0,4
	0,841	90	Opti Uncoated Paper 90g 0,841 x 90m	88087968	-	26,46	0,35
	0,914	50	Opti Uncoated Paper 90g 0,914 x 50m	88087963	-	16,63	0,36
	0,914	90	Opti Uncoated Paper 90g 0,914 x 90m	88087964	-	27,63	0,34
	1,067	50	Opti Uncoated Paper 90g 1,067 x 50m	88160083	-	23,09	0,43



# Opti®



## Coated Inkjet Paper

Wit gecoat papier voor 4-kleurenwerk en proofings  
Papier blanc couché pour la réalisation de quadrichromie et épreuves.

			Box Label	Ref. Papyrus	€/roll	
--	--	--	-----------	--------------	--------	--

### Opti Matt Coated Paper 90g

(Full Color Paper-8075-739)

90 Gr.	0,42	45,7	Opti Matt Coated Paper 90g 0,420 x 45,7m	88089440	-	12,01	0,63
	0,594	90	Opti Matt Coated Paper 90g 0,594 x 90m	88089439	-	31,26	0,58
	0,61	45,7	Opti Matt Coated Paper 90g 0,610 x 45,7m	88089434	-	17,73	0,64
	0,841	120	Opti Matt Coated Paper 90g 0,841 x 120m	88089438	-	44,28	0,44
	0,914	45,7	Opti Matt Coated Paper 90g 0,914 x 45,7m	88089435	-	26,04	0,62
	0,914	90	Opti Matt Coated Paper 90g 0,914 x 90m	88089436	-	48,18	0,59
	1,067	45,7	Opti Matt Coated Paper 90g 1,067 x 45,7m	88089437	-	30,75	0,63

### Opti Matt Coated Paper 120g

(Graphic Arts Poster Paper-742)



120 Gr.	0,61	30	Opti Matt Coated Paper 120g 0,610 x 30m	88089651	-	15,74	0,86
	0,914	30	Opti Matt Coated Paper 120g 0,914 x 30m	88089648	-	23,62	0,86
	1,067	30	Opti Matt Coated Paper 120g 1,067 x 30m	88089649	-	27,55	0,86
	1,067	100	Opti Matt Coated Paper 120g 1,067 x 100m	88102800	-	87,49	0,82
	1,27	30	Opti Matt Coated Paper 120g 1,270 x 30m	88089650	-	32,8	0,86
	1,27	90	Opti Matt Coated Paper 120g 1,270 x 90m	88103882		104,14	0,91





## Coated Inkjet Paper (Vervolg - suite)

Wit gecoat papier voor 4-kleurenwerk en proofings

Papier blanc couché pour la réalisation de quadrichromie et épreuves

			Box Label	Ref. Papyrus	€/roll 	€/m² 
--	--	--	--------------	-----------------	------------	----------

### Opti Bright Matt Coated Poster Paper 160g

(EasyLam Poster Paper-745)



160 Gr.	0,61	30	Opti Matt Coated Paper Easylam 160g 0,610 x 30m	88103840	-	24,71	1,35
	0,914	30	Opti Matt Coated Paper Easylam 160g 0,914 x 30m	88089228	-	37,11	1,35
	1,067	30	Opti Matt Coated Paper Easylam 160g 1,067 x 30m	88100574	-	43,3	1,35
	1,118	30	Opti Matt Coated Paper Easylam 160g 1,118 x 30m	88103842	-	45,28	1,35
	1,27	30	Opti Matt Coated Paper Easylam 160g 1,270 x 30m	88103837	-	51,44	1,35
	1,524	30	Opti Matt Coated Paper Easylam 160g 1,524 x 30m	88089227		61,72	1,35

### Opti Barrier Coated Matt 180g

Opti Barrier Coated Matt 180g

Opti Barrier Coated Matt 180g

180 Gr.	0,61	30	Opti Barrier Coated Matt 180g 0,61 x 30m	88217136	-	40,26	2,20
	0,914	30	Opti Barrier Coated Matt 180g 0,91 x 30m	88217141	-	60,32	2,20
	1,067	30	Opti Barrier Coated Matt 180g 1,067 x 30m	88102824	-	70,42	2,20
	1,27	30	Opti Barrier Coated Matt 180g 1,27 x 30m	88217143		83,82	2,20
	1,524	30	Opti Barrier Coated Matt 180g 1,524 x 30m	88103838	-	100,58	2,20

### Opti Power Paper 140g

140 Gr.	0,914	30	Opti Power Paper 140g 0,914 x 30m	88091412	-	36,42	1,33
	1,067	30	Opti Power Paper 140g 1,067 x 30m	88102827	-	42,47	1,33

### Opti Coloured Poster Paper 100g

Suni-Jet geel  
Jaune



100 Gr.	0,61	45	Opti Suni-Jet Yellow 100g 0,610 x 45m	88103876	2 roll / pack	24,63	0,9
	0,61	90	Opti Suni-Jet Yellow 100g 0,610 x 90m	88103850	End of Stock	49,25	0,9

### Opti Jet Fire Proof

Wit brandbestendig posterpapier M1

Papier poster résistant au feu M1



130	1,067	90	Opti Jet Fire Proof M1 130g 1,067 x 90m	88127644		130,94	1,36
-----	-------	----	---	----------	--	--------	------



## Photo Coated Inkjet Paper

Wit gecoat papier voor 4-kleurenwerk en proofings

Papier blanc couché pour la réalisation de quadrichromie et épreuves

			Box Label	Ref. Papyrus	€/roll 	€/m² 
--	--	--	--------------	-----------------	------------	----------

### Opti Photo Paper Gloss 200g - (Master Photo Paper Gloss)

PE fotopapier met instant dry coating, houdbaarheid ca 1 jaar

Papier photo PE avec instant dry coating, durabilité ca 1 an

200 Gr.	0,61	30	Opti Photo Paper Gloss 200g 0,610 x 30m	88091315	-	59,96	3,28
	0,914	30	Opti Photo Paper Gloss 200g 0,914 x 30m	88091316	-	89,87	3,28
	1,067	30	Opti Photo Paper Gloss 200g 1,067 x 30m	88091317	-	104,9	3,28
	1,27	30	Opti Photo Paper Gloss 200g 1,270 x 30m	88090009	-	123,93	3,25
	1,524	30	Opti Photo Paper Gloss 200g 1,524 x 30m	88091318	-	149,83	3,28

### Opti Photo Paper Semi-Gloss 200g - (Master Photo Paper Satin)

PE fotopapier met instant dry coating, houdbaarheid ca 1 jaar

Papier photo PE avec instant dry coating, durabilité ca 1 an

200 Gr.	0,61	30	Opti Photo Paper Satin 200g 0,610 x 30m	88091322	-	59,96	3,28
	0,914	30	Opti Photo Paper Satin 200g 0,914 x 30m	88091323	-	89,89	3,28
	1,067	30	Opti Photo Paper Satin 200g 1,067 x 30m	88090010	-	104,9	3,28
	1,27	30	Opti Photo Paper Satin 200g 1,270 x 30m	88101671	-	124,93	3,28

### Opti Instant Dry Photo Paper Gloss 190

PE fotopapier met instant dry coating, extra lange houdbaarheid

Papier photo PE avec instant dry coating, durabilité très longue

190 Gr.	0,61	30	Opti Photo Paper Gloss 190g 0,610 x 30m	88102012	-	66,67	3,64
	0,914	30	Opti Photo Paper Gloss 190g 0,914 x 30m	88102014	-	99,79	3,64
	1,067	30	Opti Photo Paper Gloss 190g 1,067 x 30m	88102010	-	116,5	3,64

### Opti Instant Dry Photo Paper Semi-Gloss 190 - (Satin)

PE fotopapier met instant dry coating, extra lange houdbaarheid

Papier photo PE avec instant dry coating, durabilité très longue

190 Gr.	0,61	30	Opti Photo Paper Satin 190g 0,610 x 30m	88102013	-	66,67	3,64
	0,914	30	Opti Photo Paper Satin 190g 0,914 x 30m	88102015	-	99,79	3,64
	1,067	30	Opti Photo Paper Satin 190g 1,067 x 30m	88102011	-	116,5	3,64
	1,27	30	Opti Photo Paper Satin 190g 1,270 x 30m	88101692	-	138,66	3,64
	1,524	30	Opti Photo Paper Satin 190g 1,524 x 30m	88101693		166,46	3,64

### Opti Photo Coated Proofing Semi-Gloss 190g

FOGRA Certified  
Certifié FOGRA



190 Gr.	0,61	30	Photo Paper Satin 190g Fogra 0,610 x 30m	88100576	-	64,53	3,53
	0,914	30	Photo Paper Satin 190g Fogra 0,914 x 30m	88103851	-	96,68	3,53
	1,067	30	Photo Paper Satin 190g Fogra 1,067 x 30m	88102460	-	112,87	3,53
	1,118	30	Photo Paper Satin 190g Fogra 1,118 x 30m	88101682	-	118,26	3,53
	1,524	30	Photo Paper Satin 190g Fogra 1,524 x 30m	88103852		161,21	3,53



## Photo Coated Inkjet Paper (Vervolg - Suite)

Wit gecoat papier voor 4-kleurenwerk en proofings

Papier blanc couché pour la réalisation de quadrichromie et épreuves

			Box Label	Ref. Papyrus	€/roll 	€/m² 
--	--	--	--------------	-----------------	------------	----------

### Opti Photo Coated Proofing Semi-Gloss 250g

FOGRA Certified  
Certifié FOGRA



250 Gr.	0,61	30	Photo Paper Satin 250g Fogra 0,610 x 30m	88101687	-	121,85	6,66
	1,067	30	Photo Paper Satin 250g Fogra 1,067 x 30m	88103855	-	213,22	6,66
	1,118	30	Photo Paper Satin 250g Fogra 1,118 x 30m	88101681		223,39	6,66

### Kodak Rapid Dry Photo Glossy Paper 190g

Photographic paper for high quality posters and photographic reproductions.

Papier photo destinée pour des posters et reproductions photographique haute qualité.

190 Gr.	0,61	30,5	Kodak 222730 RD Glossy 190 0,610 x 30,5m	88104022	-	94,26	5,07
	0,914	30,5	Kodak 222730 RD Glossy 190 0,914 x 30,5m	88104023	-	141,2	5,07
	1,27	30,5	Kodak 222730 RD Glossy 190 1,27x 30,5m	88104025	-	188,64	4,87

### Kodak Rapid Dry Photo Satin Paper 190g

Photographic paper for high quality posters and photographic reproductions.

Papier photo destinée pour des posters et reproductions photographique haute qualité.

190 Gr.	0,61	30,5	Kodak 222737 RD Satin 190 0,610 x 30,5m	88104027	-	94,26	5,07
	0,914	30,5	Kodak 222737 RD Satin 190 0,914 x 30,5m	88104028	-	141,2	5,07
	1,067	30,5	Kodak 222739 RD Satin 190 1,067 x 30,5m	88104029	-	164,84	5,07
	1,524	30,5	Kodak 222741 RD Satin 190 1,524 x 30,5m	88104031	-	226,36	4,87

### Kodak Premium Rapid Dry Photo Glossy Paper 255g

Photographic paper for high quality photographic reproductions.

Papier photo destinée pour des reproductions photographique haute qualité.

	0,61	30,5	Kodak KPRDPG24 Glossy 255g 0,610 x 30,5m	88104061	-	120,28	6,46
--	------	------	--	----------	---	--------	------

### Kodak Premium Rapid Dry Photo Lustre Paper 255g

Photographic paper for high quality photographic reproductions.

Papier photo destinée pour des reproductions photographique haute qualité.

255 Gr.	0,432	30,5	Kodak KPRDPL17 Lustre 255g 0,432 x 30,5m	88149686		85,2	6,47
	0,61	30,5	Kodak KPRDPL24 Lustre 255g 0,610 x 30,5m	88104065	-	120,28	6,46
	0,914	30,5	Kodak KPRDPL36 Lustre 255g 0,914 x 30,5m	88104066	-	180,22	6,46
	1,067	30,5	Kodak KPRDPL42 Lustre 255g 1,067 x 30,5m	88104067	-	210,38	6,46
	1,117	30,5	Kodak KPRDPL44 Lustre 255g 1,117 x 30,5m	88104068		220,42	6,47
	1,524	30,5	Kodak KPRDPL60 Lustre 255g 1,524 x 30,5m	88149683	End of Stock	252,48	5,43



## Canvas

			Box Label	Ref. Papyrus	€/roll	€/m²
--	--	--	-----------	--------------	--------	------

### Opti Canvas Matt Universal Textile

100% Cotton, 1:1 structure, zeer stabiel  
100% Cotton, Très stable - (Water resistant Canvas 9172)

350Gr.	0,61	15,2	Opti Canvas Matt Universal 0,610 x 15,2m	88087987	-	202,29	21,82
	0,914	15,2	Opti Canvas Matt Universal 0,914 x 15,2m	88087988	-	303,11	21,82
	1,067	15,2	Opti Canvas Matt Universal 1,067 x 15,2m	88087989	-	353,85	21,82
	1,27	15,2	Opti Canvas Matt Universal 1,270 x 15,2m	88103510	-	421,18	21,82
	1,524	15,2	Opti Canvas Matt Universal 1,524 x 15,2m	88087990	-	505,42	21,82

### Opti Polyester Canvas

	1,067	30	Opti Canvas Polyester 1,067 x 30m	88142475	-	171,89	5,37
	1,118	30	Opti Canvas Polyester 1,118 x 30m	88139598	-	180,11	5,37
	1,524	30	Opti Canvas Polyester 1,524 x 30m	-	-	245,52	5,37

Voor de bescherming van uw canvasprint, gebruik de Hahnemühle spray of vernis, zie laatste blz, van dit tarief.  
Pour la protection de vos images sur le canvas, utilisez le spray ou vernis Hahnemühle, info sur la dernière page de ce tarif.



## Roll-Up / Pop-up

Witte rug  
Dos blanc

			Box Label	Ref. Papyrus	€/roll	€/m²
--	--	--	-----------	--------------	--------	------

### Opti Roll-Up

Polyester base  
Base en Polyester

240µ	0,914	30	Opti Roll-Up 793 240µ 0,914 x 30m	88103832	-	149,56	5,45
	1,067	30	Opti Roll-Up 793 240µ 1,067 x 30m	88103833	-	174,6	5,45
	1,27	30	Opti Roll-Up 793 240µ 1,270 x 30m	88103834		207,82	5,45
	1,524	30	Opti Roll-Up 793 240µ 1,524 x 30m	88103846		249,38	5,45

### Opti Pop-Up

Polyester base  
Base en Polyester

350µ	0,914	30	Opti Pop-Up 794 350µ 0,914 x 30m	88103847	-	249,76	9,11
	1,067	30	Opti Pop-Up 794 350µ 1,067 x 30m	88103848		291,58	9,11
	1,27	30	Opti Pop-Up 794 350µ 1,270 x 30m	88103849		347,05	9,11



## Scrim Banner Vinyl

Waterresistente zeildoek  
Bâche résistante à l'eau

			Box Label	Ref. Papyrus	€/roll	
--	--	--	-----------	--------------	--------	--

### Kodak Water-Resistant Scrim Banner

0,914	12,2	Kodak WR Scrim Banner 0,914 x 12,2m	88103894	-	110,78	9,93
1,067	12,2	Kodak WR Scrim Banner 1,067 x 12,2m	88103895		130,24	10,01

### Opti Premium Scrim Banner

380µ	0,914	12,2	Opti Premium Scrim Banner 380µ 0,914 x 12,2m	88091443	-	117,67	10,55
	1,067	12,2	Opti Premium Scrim Banner 380µ 1,067 x 12,2m	88091442	-	137,35	10,55

### Opti Scrim Banner Matt

400µ	0,914	18	Opti Scrim Banner Matt 400µ 0,914 x 18m	88103915	-	143,63	8,73
------	-------	----	---	----------	---	--------	------



## Backlit Films

Polyester (top coated)  
Polyester enduit

			Box Label	Ref. Papyrus	€/roll	
--	--	--	-----------	--------------	--------	--

### Opti Polyester Front Print Backlit Film 170µ

170µ	0,914	30	Opti Universal Backlit 170µ 0,914 x 30m	88087839		174,56	6,37
	1,067	30	Opti Universal Backlit 170µ 1,067 x 30m		-	203,7	6,36

### Kodak Universal Front Print Backlit Film 8mil

200µ	0,61	30,5	Kodak Backlit Film 8mil 0,610 x 30,5m	88103977	-	159,48	8,57
	0,914	30,5	Kodak Backlit Film 8mil 0,914 x 30,5m	88103978	-	238,94	8,57
	1,067	30,5	Kodak Backlit Film 8mil 1,067 x 30,5m	88103979	-	278,94	8,57



## Self Adhesive Vinyl

Zelfklevende mat en glossy vinyl  
Vinyle adhésif mat et brillant

			Box Label	Ref. Papyrus	€/roll	
--	--	--	-----------	--------------	--------	--

### Opti Mat Stretch Vinyl

Permanent - mat wit  
Vinyl Permanent blanc mat

270µ	0,914	30	Opti 14117 mat stretch vinyl 0,914 x 30m	88090834	-	151,9	5,54
	1,067	30	Opti 14117 mat stretch vinyl 1,067 x 30m	88101694	-	177,32	5,54
	1,27	30	Opti 14117 mat stretch vinyl 1,270 x 30m	88101660		211,03	5,54

### Hexis V890 Matt Vinyl - Pigment

Permanent - mat wit  
Vinyl Permanent blanc mat

135µ	1,27	20	HexisV890WR Matt Vinyl 1,270 x 20m	88103640		203,962	8,03
------	------	----	------------------------------------	----------	--	---------	------

## Self Adhesive Polyester Textile

Zelfklevend mat polyester met textielstructuur - alternatief voor behang  
Polyester mat adhésif avec structure textile - alternative au papier peint

			Box Label	Ref. Papyrus	€/roll	
--	--	--	-----------	--------------	--------	--

### Kodak PHOTO TEX Self Adhesive Polyester Textile

Zelfklevend herpositioneerbaar textiel  
Textile adhésif repositionnable

	0,61	30,5	Kodak PHOTO TEX 0,610 x 30,5m	88158098		445,92	23,97
	1,067	30,5	Kodak PHOTO TEX 1,067 x 30,5m	88158098		652,74	20,06
	1,524	30,5	Kodak PHOTO TEX 1,524 x 30,5m	88158099		950,86	20,46



## Wall Covering

Latexgebaseerde nylon, versterkte wandbekleding voor woningen, horeca, commerciële en retail design. MuralPro is een economisch alternatief voor zelfklevend vinyl voor in-store-muurbekleding en graphics, Revêtement mural à base latex, renforcé de nylon pour les habitations, horeca, design commercial et retail. MuralPro est une alternative économique au vinyle pour décoration murale

			Box Label	Ref. Papyrus		
--	--	--	-----------	--------------	--	--

### Mural Pro Wall Covering

287μ	0,61	22,86	Magic Mural Pro 0,610 x 22,86m	88103966		174,62	12,52
------	------	-------	--------------------------------	----------	--	--------	-------



## Opti®



## Magnetic Products

Ijzerhoudende printfilm die kan worden aangebracht op de magneetfilm (zelfklevend, aan te brengen op een gladde muur.

Film contenant du fer qui est imprimé et qui adhère sur du film magnétique adhésif qui est collé sur un mur lisse.

			Box Label	Ref. Papyrus		
--	--	--	-----------	--------------	--	--

### Teslaflex IJ Waterbased

Witte polyprop ijzerhoudende printfolie  
Film en Polypropylène blanc contenant du fer

340g	1,07	30	Teslaflex IJ Waterbased 1,070 x 30m	88195914		240,75	7,5
------	------	----	-------------------------------------	----------	--	--------	-----

### Teslabase Adhesive Magnetic

Zelfklevende magneetfolie 0,9 mm, Het ijzerhoudende Teslaflex is hierop gemakkelijk aan te brengen.  
Film magnétique 0,9 mm adhésif qui sert de support au Teslaflex

900μ	0,62	15	Teslabase Brown 0,620 x 15m	88137472		97,65	10,5
	1	15	Teslabase Brown 1,000 x 15m	88137751	-	157,5	10,5



## Fine Art Paper

			Box Label	Ref. Papyrus	€/roll	
--	--	--	-----------	--------------	--------	--

### Hahnemühle Photo Rag

100% cotton, wit, Fijne, glad oppervlak ideaal voor het afdrukken van zowel zwart-wit als kleurenfoto's en kunstproducties.  
100% cotton blanc, Surface fine et lisse, papier très polyvalent et idéal pour l'impression de photos en noir/blanc et couleurs et des reproductions d'art.

188 Gr.	0,61	12	Hahnemühle Photo Rag 188g 0,610 x 12m		⌚	124,42	17
	0,914	12	Hahnemühle Photo Rag 188g 0,914 x 12m		⌚	184,6	16,83
	1,117	12	Hahnemühle Photo Rag 188g 1,117 x 12m		⌚	223,38	16,67
308 Gr.	0,61	12	Hahnemühle Photo Rag 308g 0,610 x 12m	88103651	⌚	175,05	23,91
	0,914	12	Hahnemühle Photo Rag 308g 0,914 x 12m		⌚	259,72	23,68
	1,117	12	Hahnemühle Photo Rag 308g 1,117 x 12m	88103652	⌚	314,4	23,46

### Hahnemühle Photo Rag Ultra Smooth

100% cotton, wit, Extra glad oppervlak met minder textuur en een helderder witte uitstraling t.o.v. gewoon "Photo Rag"  
100% cotton, blanc, Surface extra lisse avec moins de texture et un blanc pur par rapport au "Photo Rag" normal

305 Gr.	0,61	12	Hahnemühle Photo Rag Ultra Smooth 305g 0,610 x 12m		⌚	175,05	
23,91							
	0,914	12	Hahnemühle Photo Rag Ultra Smooth 305g 0,914 x 12m		⌚	259,72	
23,68							
	1,117	12	Hahnemühle Photo Rag Ultra Smooth 305g 1,117 x 12m		⌚	314,4	23,46

### Hahnemühle Bamboo

90%, 10% cotton, wit, Gemaakt van bamboevezels, bijzonder geschikt voor warmgetinte kleur- en zwart-wit prints  
90%, 10% cotton, blanc, Fait à partir de fibres de bambou, particulièrement adapté pour des impressions blanc/ noir et couleurs chaudes

290 Gr.	0,61	12	Hahnemühle Bamboo 290g 0,610 x 12m		⌚	161,26	22,03
	0,914	12	Hahnemühle Bamboo 290g 0,914 x 12m		⌚	239,85	21,87
	1,117	12	Hahnemühle Bamboo 290g 1,117 x 12m		⌚	290,09	21,64

### Hahnemühle Photo Rag Ultra Bright White

Helder wit papier 100% katoen, ideaal voor beelden met hoog contrast.  
Papier blanc 100% coton, idéal pour des images au contraste élevé.

310 Gr.	0,61	12	Hahnemühle Photo Rag Ultra Bright White 310g 0,610 x 12m	88103653	⌚	175,14	
23,93							
	1,117	12	Hahnemühle Photo Rag Ultra Bright White 310g 1,117 x 12m	88103654	⌚	314,6	23,47

### Hahnemühle William Turner

Wit papier 100% katoen met een matte waterverftextuur, William Turner is ideaal voor reproducties van traditionele kunstwerken en ook voor opvallende en expressieve fotoreproducties.

Papier blanc 100% coton avec un aspect mat aquarelle William Turner est idéal pour la reproduction d'oeuvres d'art traditionnelles et aussi pour des reproductions frappantes et expressives de photos.

190 Gr.	0,61	12	Hahnemühle William Turner 190g 0,610 x 12m	88103659	⌚	128,4	17,54
	1,117	12	Hahnemühle William Turner 190g 1,117 x 12m	88103660	⌚	230,58	17,2
310 Gr.	0,43	12	Hahnemuehle William Turner 310g 0,430 x 12m	88157045	-	127,54	24,72
	0,61	12	Hahnemuehle William Turner 310g 0,610 x 12m	88103658	-	178,15	24,34
	0,914	12	Hahnemuehle William Turner 310g 0,914 x 12m	88157047	-	264,65	24,13
	1,117	12	Hahnemuehle William Turner 310g 1,117 x 12m	88128405	-	320,18	23,89





## Fine Art Paper (Vervolg - Suite)

			Box Label	Ref. Papyrus	€/roll	
--	--	--	-----------	--------------	--------	--

### Hahnemühle German Etching

Wit papier 100% cellulose, fluwelig glad met een fijne oppervlaktestructuur.  
Papier blanc 100% cellulose, lissé de velours et structure de surface fine.

310 Gr.	0,61	12	Hahnemuehle German Etching 310g 0,610 x 12m	88103648		149,22	20,38
	0,914	12	Hahnemuehle German Etching 310g 0,914 x 12m	88103649		221,97	20,24
	1,117	12	Hahnemuehle German Etching 310g 1,117 x 12m	88103650		268,52	20,03

### Hahnemühle Photo Rag Baryta

Glanzend wit papier 100% katoen, zeer fijne oppervlaktestructuur met bariet glans.  
Papier blanc brillant 100% coton, structure de surface très fine avec le brillant bariet.

315 Gr.	0,61	12	Hahnemuehle Photo Rag Baryta 310g 0,610 x 12m			198,78	27,16
	0,914	12	Hahnemuehle Photo Rag Baryta 310g 0,914 x 12m			295,02	26,9
	1,117	12	Hahnemuehle Photo Rag Baryta 310g 1,117 x 12m			356,8	26,62

### Hahnemühle Photo Rag Pearl

Glanzend wit papier 100% katoen, zeer fijne oppervlaktestructuur met bariet glans.  
Papier blanc brillant 100% coton, structure de surface très fine avec le brillant bariet.

320 Gr.	0,43	12	Hahnemuehle Photo Rag Pearl 310g 0,430 x 12m	88103655		137,86	26,72
	1,117	12	Hahnemuehle Photo Rag Pearl 310g 1,117 x 12m	88103656		346,38	25,84

### Hahnemühle Fine Art Baryta

Glanzend wit papier 100% katoen, zeer fijne oppervlaktestructuur met bariet glans.  
Papier blanc brillant 100% coton, structure de surface très fine avec le brillant bariet.

325 Gr.	0,43	12	Hahnemuehle Fine Art Baryta 0,430 x 12m	88103663		133,97	25,96
	0,61	12	Hahnemuehle Fine Art Baryta 0,610 x 12m	88103664		187,43	25,61

### Hahnemühle Fine Art Pearl

Glanzend wit papier 100% katoen, zeer fijne oppervlaktestructuur met bariet glans.  
Papier blanc brillant 100% coton, structure de surface très fine avec le brillant bariet.

285 Gr.	1,118	12	Hahnemuehle Fine Art Pearl 285 1,118x12m	88103647		326,92	24,37
---------	-------	----	--	----------	--	--------	-------



## Spray, Vernis



Box  
Label

Ref.  
Papyrus

€/st.-pce

### Hahnemühle Protective Spray

Hahnemühle Protective Spray biedt bescherming aan uw geprinte beelden. De geurloze spray beschermt de bedrukte oppervlakken tegen vuil, vingerafdrukken en vochtigheid. Het verhoogt de waterbestendigheid van de afdrukken en beschermt beelden tegen verkleuring door UV-stralen.

Hahnemühle Protective Spray protège vos images imprimées. Ce spray inodore protège les surfaces imprimées contre la saleté, les empreintes de doigts et l'humidité. Il augmente la résistance à l'humidité et protège l'image de la décoloration due aux rayons UV.2

1	1	HahnemuehleProtectiveSpray	88103733		20,25
---	---	----------------------------	----------	--	-------

### Hahnemühle Vernis

1	1	Hahnemühle Satin Vernis 1L	88131145		40,22
1	1	Hahnemühle Matt Vernis 1L	88131146		40,22



## Inkjet Sublimation Transfert Paper

Dye sublimation paper produces exceptional quality colour for printing onto both hard and soft surfaces. It delivers high definition images with smoother solids, graduations and more life-like skin tones and crisp results especially on images with smaller text. These papers are specially designed to hold the ink on the surface without the paper becoming too wet and then "cockling" due to over saturation.

Le papier à sublimation produit des couleurs d'une qualité exceptionnelle pour l'impression sur des surfaces rigides et souples. Il délivre des images haute définition avec des aplats plus lisses, des graduations et des tons de peau plus réalistes et des résultats nets, en particulier sur les images avec un petit texte. Ces papiers sont spécialement conçus pour maintenir l'encre sur la surface sans que le papier ne devienne trop mouillé et ensuite "gondole" en raison de la saturation excessive.



Box  
Label

Ref.  
Papyrus

€/roll

€/m<sup>2</sup>

### Sublimation Paper

#### True Pix Sublimation Paper

90 Gr.	0,63	60,96	True Pix Sublimation Paper 0,63 x 60,96m	88270848	116,67	3,04
110 Gr.	1,12	30,48	True Pix Sublimation Paper 1,12 x 30,48m	88274465	99,61	2,92
110 Gr.	1,62	91,44	True Pix Sublimation Paper 1,62 x 91,44m	88274463	395	2,67

# Papyrus Viscom

Prijslijst / Liste de prix  
Protection Films



**PAPYRUS** 

Your partner in Visual Communication



# Protection Films

## AVERY Laminates - LAMINATION AVERY

CAST Laminates - Films de Laminations Coulés	
Avery DOL 1460Z Hoogglanzend 3D-Laminaat - Laminat 3D très brillant . . . . .	.143
Avery DOL 1480Z Mat 3D-Laminaat - Laminat 3D mat. . . . .	.143
Avery DOL 6040 Sparkle Clear Glanzend Sparkle Laminaat - Laminat Transparent pailletté Brillant . . . . .	.143
Polyurethane Free PVC Laminates - Films de Lamination Polyuréthane sans PVC	
Avery DOL 6460 Glanzend 2D-Laminaat - Laminat 2D brillant. . . . .	.143
POLYMERIC Laminates - Films Adhésifs de Lamination Polymères	
Avery DOL 2460 Glanzend laminaat - Laminat brillant . . . . .	.144
Avery DOL 2480 Mat laminaat - Laminat mat. . . . .	.144
Avery DOL 2470 Semi-matt (lustre) Laminaat - Laminat semi-matt (lustre) . . . . .	.144
Avery DOL 2100 Mat laminaat - Laminat mat. . . . .	.144
Avery DOL 2200 Semi-matt (lustre) Laminaat - Laminat semi-matt (lustre) . . . . .	.144
Avery DOL 2860 Glanzend promotioneel Laminaat - Laminat brillant promotionnel . . . . .	.144
Avery DOL 2880 Mat promotioneel Laminaat - Laminat mat promotionnel . . . . .	.144
MONOMERIC Laminates - Films de Laminations Monomères	
Avery DOL 3460 Glanzend laminaat - Laminat brillant . . . . .	.145
Avery DOL 3480 Mat Laminaat - Laminat mat . . . . .	.145
Avery DOL 3200 Semi-glanzend (lustre) Laminaat - Laminat semi-brillant (lustre). . . . .	.145
Avery DOL 3470 Semi-glanzend (lustre) Laminaat - Laminat semi-brillant (lustre). . . . .	.145
Anti Graffiti Polyester Laminates - Films de Laminations Polyester Anti Graffiti	
Avery DOL 4300 Glanzend Polyester laminaat - Laminat Polyester brillant . . . . .	.145
Floor Laminates - Films de Laminations pour le sol	
Avery DOL 5900 . . . . .	.145
Avery DOL 6000 . . . . .	.145

## Avery Architectural Window Films - FILM ARCHITECTURAL AVERY POUR VITRE

ZONNEBESCHERMING - Interieurtoepping - PROTECTION SOLAIRE - Application Intérieure	
DR Grey 05 i Perm-PET . . . . .	.146
DR Grey 15 i Perm-PET - . . . . .	.146
DS Matte i Perm-PET . . . . .	.146
DS UV Filter i Perm-PET . . . . .	.146
R Silver 20 i Perm-PET. . . . .	.146
R Silver 35 i Perm-PET - . . . . .	.146
R Silver 50 i Perm-PET - . . . . .	.146
SS Natural 45 i Perm-PET . . . . .	.146
SS Natural 70 i Perm-PET - . . . . .	.146
ZONNEBESCHERMING - Buitentoepping - PROTECTION SOLAIRE - Application Exterieur	
DR Grey 10 x Perm-PET . . . . .	.147
DR Grey 20 x Perm-PET - . . . . .	.147
DR Grey 35 X Perm-PET - . . . . .	.147
DR Grey 50 X Perm-PET - . . . . .	.147
R Silver 20 X Perm-PET . . . . .	.147
R Silver 35 X Perm-PET - . . . . .	.147
R Silver 50 X Perm-PET - . . . . .	.147
R Silver 20 X Poly-PET . . . . .	.147
SS Natural 70 X Perm-PET - . . . . .	.147
SS Blue 75 X Perm-PET - . . . . .	.147

## HEXIS Laminates - LAMINATION HEXIS

CAST Laminates - Films de Laminations Coulés	
Hexis PC30G2 Glanzend 3D-Laminaat - Laminat 3D brillant . . . . .	.148
Hexis PC30M3 Mat 3D-Laminaat - Laminat 3D Mat. . . . .	.148
Hexis PC190G2 Glanzend 3D-Laminaat - Laminat 3D Brillant . . . . .	.148
Hexis PC190M3 Mat 3D-Laminaat - Laminat 3D Mat . . . . .	.148
POLYMERIC Laminates - Films de Laminations Polymères	
Hexis V750B Glanzend laminaat - Laminat brillant . . . . .	.148
Hexis V750M Mat laminaat - Laminat mat . . . . .	.148
Hexis VCR750B Glanzend laminaat met versterkte lijmlaag - Laminat brillant adh, renforcé . . . . .	.148
Hexis VCR750M Mat laminaat met versterkte lijmlaag - Laminat mat adh, Renforcé. . . . .	.148
HYBRID Laminates - Films de Laminations Hybides	
Hexis V740B Glanzend Laminaat - Laminat Brillant . . . . .	.149
MONOMERIC Laminates - Films de Laminations Monomères	
Hexis V700B Glanzend laminaat - Laminat brillant . . . . .	.149
Hexis V700M Mat laminaat - Laminat mat . . . . .	.149
Hexis V700S Satijn laminaat - Laminat satin. . . . .	.149
Kit moto PVC Laminates - moto, Quad, Jet-ski - Plastification PVC - Kit moto, Quad, Jet-ski	
Hexis VRK300B Glanzend laminaat - Laminat brillant . . . . .	.149
Hexis VRK300M Mat laminaat - Laminat Mat . . . . .	.149
Anti Graffiti Polyester Laminates - Films de Laminations Polyester Anti Graffiti	
Hexis AG436M Anti-Graffiti Matte anti-graffiti outdoor Polyester - Laminat polyester mat pour application en extérieur . . . . .	.150
Hexis AG700 Anti-Graffiti Glanzend Polyester - Laminat polyester brillant . . . . .	.150
Hexis AGCR700 Anti-Graffiti Glanzend Polyester - Laminat polyester brillant . . . . .	.150
Hexis AG800 Anti-Graffiti and Anti Scratch Glanzend Polyester - Laminat polyester brillant. . . . .	.150
Floor Laminates - Films de laminations pour visuels au sol	
Hexis GFLi 30 Monomeer gestructureerd transparante PVC - PVC transparent monomère structuré. . . . .	.151
Hexis GFLi 170 Monomeer gestructureerd transparante PVC - PVC transparent monomère structuré . . . . .	.151
Hexis GFLX 210 Monomeer gestructureerd transparante PVC - PVC transparent monomère structuré . . . . .	.151

Hexis GFLXR 210 Monomeer gestructureerd transparante PVC - PVC transparent monomère structuré - Colle renforcée . . .	151
Hexis GFLX 230 Monomeer gestructureerd transparante PVC - PVC transparent monomère structuré . . . . .	151
Hex'Perience - Structurated Laminates - Hex'Perience - Film de lamination Structurés	
Hexis Vwood PVC Polymeer laminaat - Plastification PVC polymère structure bois. . . . .	151
Hexis PCWALL Gegoten PVC - Lamination PVC Coulée . . . . .	151
Hexis PCCARBON Gegoten PVC - Lamination PVC Coulée . . . . .	151
Hexis PCGATOR Gegoten PVC - Lamination PVC Coulée . . . . .	151
Hexis PCBRUSHED Gegoten PVC - Lamination PVC Coulée . . . . .	151
Hexis PC Star Film de lamination - Effet Pailleté	
Hexis PC Star01G Gegoten PVC - Lamination PVC Coulée . . . . .	152
Hexis PC Star01S Gegoten PVC - Lamination PVC Coulée . . . . .	152
Hexis PC Star02G Gegoten PVC - Lamination PVC Coulée . . . . .	152
Hexis PC Star03G Gegoten PVC - Lamination PVC Coulée . . . . .	152
Hexis PC Star04G Gegoten PVC - Lamination PVC Coulée . . . . .	152
Laminates for Perforated Window Film - Film de lamination pour mirco perforé	
Hexis PC50MICP2 Gegoten PVC - PVC Coulé. . . . .	152
Hexis PG836 Glanzend polyester - Polyester brillant. . . . .	152

## STICKYBITS Laminates - LAMINATION STICKYBITS





MONOMERIC Laminates - Films de Laminations Monomères	
Stickybits Laminate Gloss Glanzend Laminaat - Laminat Brillant. . . . .	153
Stickybits Laminate Satin Semi glanzend laminaat - Laminat semi-brillant. . . . .	153
Stickybits Laminate Matt Mat laminaat - Laminat mat. . . . .	153
Stickybits Laminate Crystal Gestructureerd laminaat - Laminat grainé . . . . .	153
Stickybits Certified Non-Slip Floor Laminate Gestructureerd laminaat - Laminat grainé. . . . .	153
Polyester Laminates - Films de Laminations Polyester	
Stickybits Optically Clear Self-Adhesive Polyester Film S607 Verwijderbare lijm - Adhésif enlevable . . . . .	153

## Stek Car Protection Films - Films de Protection Stek pour Véhicule

STEK PAINT PROTECTION FILM	
Film de protection de Carrosserie STEK	
Stek DYNO Shield Hydrofobic - HYDROphobe® - high gloss - HYDROphobe® - Ultra Brillant, . . . . .	154
Stek DYNO MATT Hydrofobic - HYDROphobe® - satin-finished matte - HYDROphobe® - finition Mat Satinée . . . . .	154
STEK DYNO Carbon - 3D carbon fiber pattern - Motif de Fibre de Carbon 3D . . . . .	154
STEK DYNO Smoke - Tint Color - Couleur Teintée . . . . .	154
STEK DYNO Shade - Smoke Color - Couleur Fumée . . . . .	155
STEK DYNO Fancy - YellowColor - Couleur Jaune. . . . .	155
STEK WINDSHIELD PROTECTION FILM	
Film de Protection de parebrise STEK	
STEK OPTIX Shield - gloss windshield protective film - film protecteur de pare-brise brillant . . . . .	155
Automotive Scorpion Window film - Film Scorpion pour vitrage de véhicule.	
Scorpion Predator Dyed 05 . . . . .	156
Scorpion Predator Dyed 20 . . . . .	156
Scorpion Carbon 70. . . . .	156

## AVERY LAMINATES - LAMINATION AVERY CAST Laminates - Films de Laminations Coulés

Zelfklevende gegoten vinylaminaten (transparent)  
Vinyles de pelliculage coulés adhésifs (transparent)

		Ref. Papyrus	Info	€/roll 	€/m <sup>2</sup> 
---	---	-----------------	------	---	---

### Avery DOL 1460Z Hoogglanzend 3D-Laminaat - Laminat 3D très brillant

30	1,067	50	88236230		532,55	9,98
	1,37	25	88222131		341,89	9,98
	1,37	50	88222132		683,77	9,98
	1,52	25	88222136		379,32	9,98
	1,52	50	88222139		758,64	9,98

### Avery DOL 1480Z Mat 3D-Laminaat - Laminat 3D mat





30	1,37	25	88222143		341,89	9,98
	1,37	50	88222144		683,77	9,98
	1,52	25	88222145		379,32	9,98
	1,52	50	88222146		758,64	9,98

### Avery DOL 6040 Sparkle Clear Glanzend Sparkle Laminaat - Laminat Transparent pailletté Brillant



30	1,37	25	88241599		543,50	15,87
----	------	----	----------	---	--------	-------

## Polyurethane Free PVC Laminates Films de Lamination Polyuréthane sans PVC

Zelfklevende gegoten vinylaminaten (transparent)  
Vinyles de pelliculage coulés adhésifs (transparent)







		Ref. Papyrus	Info	€/roll 	€/m <sup>2</sup> 
---	---	-----------------	------	---	---

### Avery DOL 6460 Glanzend 2D-Laminaat - Laminat 2D brillant

38	1,37	50	88240022		893,22	13,04
38	1,52	50	88240020		991,02	13,04

## POLYMERIC Laminates Films Adhésifs de Lamination Polymères





Zelfklevende gekalanderde polymeervinylaminaten (transparant)  
Vinyles de pelliculage adhésifs calandrés polymères (transparent)

				Ref. Papyrus	Info		
						€/roll	€/m <sup>2</sup>
<b>Avery DOL 2460 Glanzend laminaat - Laminat brillant</b>							
80	1,067	50		88247111		305,73	5,73
	1,37	50		88247114		392,55	5,73
	1,52	50		88247118		435,53	5,73
	1,6	50		88247120		458,45	5,73
<b>Avery DOL 2480 Mat laminaat - Laminat mat</b>							
80	1,067	50		88247121		304,35	5,70
	1,37	50		88247159		390,78	5,70
	1,52	50		88247160		433,57	5,70
	1,6	50		88247161		456,39	5,70
<b>Avery DOL 2470 Semi-matt (lustre) Laminaat - Laminat semi-matt (lustre)</b>							
80	1,067	50		88247162		325,34	6,10
	1,37	50		88247158		417,73	6,10
	1,52	50		88247166		463,46	6,10
	1,6	50		88297040		487,85	6,10
<b>Avery DOL 2200 Semi-matt (lustre) Laminaat - Laminat semi-matt (lustre)</b>							
	1,52	50		88105453	End of stock	463,46	6,10
<b>Avery DOL 2860 Glanzend promotioneel Laminaat - Laminat brillant promotionnel</b>							
80	1,067	50		88247171		214,07	4,01
	1,37	50		88247169		274,86	4,01
	1,52	50		88247168		304,95	4,01
	1,6	50		88247172		321,00	4,01
<b>Avery DOL 2880 Mat promotioneel Laminaat - Laminat mat promotionnel</b>							
80	1,067	50		88247177		208,82	3,91
	1,37	50		88247175		268,12	3,91
	1,52	50		88247173		297,48	3,91
	1,6	50		88247178		313,13	3,91







## MONOMERIC Laminates Films de Laminations Monomères

Zelfklevende gekalanderde monomeervinylaminaten (transparant)  
Vinyles de pelliculage adhésifs calandrés monomères (transparent)

				Ref. Papyrus	Info	€/roll 	€/m <sup>2</sup> 
<b>Avery DOL 3460 Glanzend laminaat - Laminat brillant</b>							
80	1,067	50		88247185		125,50	2,35
	1,37	50		88247186		161,14	2,35
	1,6	50		88247188		188,20	2,35
<b>Avery DOL 3480 Mat Laminaat - Laminat mat</b>							
80	1,067	50		88247189		125,50	2,35
	1,37	50		88247190		161,14	2,35
	1,6	50		88247191		188,20	2,35
<b>Avery DOL 3200 Semi-glanzend (lustre) Laminaat - Laminat semi-brillant (lustre)</b>							
80	1,067	50		88105515	End of Stock	125,50	2,35
<b>Avery DOL 3470 Semi-glanzend (lustre) Laminaat - Laminat semi-brillant (lustre)</b>							
80	1,067	50		88247193		125,50	2,35
	1,37	50		88247194		161,14	2,35
	1,55	50		88247195		182,32	2,35
	1,6	50		88247196		188,20	2,35

## Anti Graffiti Polyester Laminates Films de Laminations Polyester Anti Graffiti





Hoogglanzend Laminaat - Vinyl de pelliculage ultrabrillant

				Ref. Papyrus	Info	€/roll 	€/m <sup>2</sup> 
<b>Avery DOL 4300 Glanzend Polyester laminaat - Laminat Polyester brillant</b>							
23	1,372	50		88125672		1200,96	17,51

## Floor Laminates Films de Laminations pour le sol

Transparant overlaminaat met een structuur, Het is bedoeld voor een kortstondige bescherming van floorgraphics, Deze kan eenvoudig worden schoongemaakt en heeft uitstekende anti-slip eigenschappen,

Film de pelliculage transparent texturé conçu afin de protéger les supports promotionnels pour les applications sur sols intérieurs,

				Ref. Papyrus	Info	€/roll 	€/m <sup>2</sup> 
<b>Avery DOL 5900 Overlaminat met een structuur, Geschikt voor MPI 3001 en 3002 - Laminat Texturé à utiliser en combinaison avec le Mpi 3001 et 3002</b>							
100	1,37	50		88195599		343,23	5,01
<b>Avery DOL 6000 Overlaminat met een structuur, Geschikt voor MPI 2001 en 2002 - Laminat Texturé à utiliser en combinaison avec le Mpi 2001 et 2002</b>							
210	1,37	50		88195600		467,33	6,82

# AVERY ARCHITECTURAL WINDOW FILMS





















## FILM ARCHITECTURAL AVERY POUR VITRE

### ZONNEBESCHERMING - Interieurtoepassing

























### PROTECTION SOLAIRE - Application Intérieure

Hoogwaardige "Solar Window Films" filteren schadelijke zonnestralen en verminderen de binnen warmte, wat de inzittenden veel voordelen oplevert, waaronder verbeterd comfort en minder verblinding, een vermindering aan verkleuring van meubels en energiekosten.

Les Solar Window Films hautes performances filtrent les rayons solaires dommageables et réduisent l'accumulation de chaleur à l'intérieur, ce qui procure de nombreux avantages aux occupants, notamment une amélioration du confort et une réduction de l'éblouissement, une absence de décoloration du mobilier et une réduction du coût énergétique.

			Ref. Papyrus	Info	% Light Transmitted	% Heat Transmitted	€/roll	€/m <sup>2</sup>
								
<b>DR Grey 05 i Perm-PET</b>								
Ces films sont typiquement utilisés dans les hôtels, les banques et les bâtiments résidentiels. Ils sont disponibles avec une finition intérieure gris neutre et une finition extérieure argentée réfléchissante, avec deux niveaux différents de transmission de la lumière.								
1,22	31	12			7	6	453,84	12,00
1,524	31	12			7	6	515,39	10,91
<b>DR Grey 15 i Perm-PET</b>								
1,22	31	12			11	9	453,84	12,00
1,524	31	12			11	9	515,39	10,91
<b>DS Matte i Perm-PET</b>								
Le film DS Matte a une apparence translucide sablée, garantissant à la fois des améliorations en matière d'intimité et de design								
0,914	31	12			66	58	181,34	6,40
1,22	31	12			66	58	242,05	6,40
1,524	31	12			66	58	274,87	5,82
<b>DS UV Filter i Perm-PET</b>								
Le film DS UV offre une protection à 100 % contre les rayons UV. Utilisés habituellement dans les musées.								
1,524	31	12			79	67	595,27	12,60
<b>R Silver 20 i Perm-PET</b>								
Ces films métallisés offrent une efficacité énergétique maximale en rejetant l'excès de rayonnement solaire et en réduisant ainsi l'accumulation de chaleur par les vitres. Une finition argentée (effet miroir) est disponible avec trois niveaux de transmission de la lumière différents.								
0,914	31	12			17	12	198,34	7,00
1,22	31	12			17	12	264,74	7,00
1,524	31	12			17	12	300,64	6,36
<b>R Silver 35 i Perm-PET</b>								
0,914	31	12			31	22	201,43	7,11
1,22	31	12			31	22	268,87	7,11
1,524	31	12			31	22	304,94	6,45
<b>R Silver 50 i Perm-PET</b>								
1,524	31	12			46	34	335,86	7,11
<b>SS Natural 45 i Perm-PET</b>								
Ces films permettent un excellent rejet de la chaleur et préservent l'aspect naturel de l'intérieur et de l'extérieur d'un bâtiment; ils sont souvent utilisés pour les bâtiments historiques. Ils sont disponibles en deux niveaux différents de transmission de la lumière.								
1,524	31	10			40	23	1610,59	34,09
<b>SS Natural 70 i Perm-PET</b>								
1,524	31	10			61	33	1803,86	38,18

## ZONNEBESCHERMING - Buitentoepassing PROTECTION SOLAIRE - Application Exterieur

				Ref. Papyrus	Info	% Light Transmitted	% Heat Transmitted	€/roll 	€/m <sup>2</sup> 
<b>DR Grey 10 x Perm-PET</b>									
Les films sont typiquement utilisés dans les hôtels, les banques et les bâtiments résidentiels. Ils sont disponibles avec une finition intérieure gris neutre et une finition extérieure argentée réfléchissante, avec quatre niveaux différents de transmission de la lumière.									
1,524	31	5				7	6	837,51	17,73
<b>DR Grey 20 x Perm-PET</b>									
1,22	31	5				18	15	700,01	18,51
1,524	31	5				18	15	794,56	16,82
<b>DR Grey 35 X Perm-PET</b>									
0,914	31	5				32	26	524,44	18,51
1,22	31	5				32	26	700,01	18,51
1,524	31	5				32	26	794,56	16,82
<b>DR Grey 50 X Perm-PET -</b>									
1,22	31	4				48	35	700,01	18,51
1,524	31	4				48	35	794,56	16,82
<b>R Silver 20 X Perm-PET</b>									
Les applications typiques incluent les bâtiments commerciaux. Une finition argentée (effet miroir) est disponible avec trois niveaux de transmission de la lumière différents.									
0,914	31	7				16	11	464,68	16,40
1,22	31	7				16	11	620,25	16,40
1,524	31	7				16	11	704,37	14,91
<b>R Silver 35 X Perm-PET -</b>									
0,914	31	7				31	22	464,68	16,40
1,22	31	7				31	22	620,25	16,40
1,524	31	7				31	22	704,37	14,91
<b>R Silver 50 X Perm-PET -</b>									
1,524	31	4				44	31	730,13	15,45
<b>R Silver 20 X Poly-PET</b>									
La version Poly est basée sur un système adhésif unique conçu pour les substrats en plastique rigide.									
1,22	31	4				16	12	983,32	26,00
1,524	31	4				16	12	1116,68	23,64
<b>SS Natural 45 X Perm-PET</b>									
Ces films permettent un excellent rejet de la chaleur et préservent l'aspect naturel de l'intérieur et de l'extérieur d'un bâtiment; ils sont souvent utilisés pour les bâtiments historiques. Ils sont disponibles en trois niveaux différents de transmission de la lumière.									
1,524	31	7				43	23	2147,45	45,45
<b>SS Natural 70 X Perm-PET -</b>									
1,524	31	7				61	33	1889,76	40,00
<b>SS Blue 75 X Perm-PET -</b>									
1,524	31	5				69	34	1503,22	31,82



## HEXIS LAMINATES - LAMINATION HEXIS CAST Laminates - Films de Laminations Coulés

Zelfklevende gegoten vinylaminaten (transparant)  
Vinyles de pelliculage coulés adhésifs (transparent)

				Ref. Papyrus	Info	€/roll 	€/m <sup>2</sup> 
<b>Hexis PC30G2 Glanzend 3D-Laminaat - Laminat 3D brillant</b>							
30	1,37	50		88103689		612,13	8,94
	1,52	50		88103690		679,15	8,94
<b>Hexis PC30M3 Mat 3D-Laminaat - Laminat 3D Mat</b>							
30	1,37	50		88103692		612,13	8,94
	1,52	50		88173977		679,15	8,94
<b>Hexis PC190G2 Glanzend 3D-Laminaat - Laminat 3D Brillant</b>							
50	1,37	50	5	88146144		685,53	10,01
	1,52	50	5	88152429		760,58	10,01
<b>Hexis PC190M3 Mat 3D-Laminaat - Laminat 3D Mat</b>							
50	1,37	50	5			685,79	10,01
	1,52	50	5			760,88	10,01

## POLYMERIC Laminates - Films de Laminations Polymères

Zelfklevende gekalanderde polymeervinylaminaten (transparant)  
Vinyles de pelliculage adhésifs calandrés polymères (transparent)

				Ref. Papyrus	Info	€/roll 	€/m <sup>2</sup> 
<b>Hexis V750B Glanzend laminaat - Laminat brillant</b>							
70	1,05	50	5	88103704		285,65	5,44
	1,37	50	5	88103705		372,70	5,44
	1,6	50	5	88103706		435,26	5,44
<b>Hexis V750M Mat laminaat - Laminat mat</b>							
70	1,37	50	5	88103707		372,70	5,44
	1,6	50	5	88103708		435,26	5,44
<b>Hexis VCR750B Glanzend laminaat met versterkte lijmlaag - Laminat brillant adh, renforcé</b> Aanbevolen voor UV afdrukken - Conseillé pour épreuves UV							
70	1,37	50	5	88103737		452,51	6,61
	1,6	50	5			528,55	6,61
<b>Hexis VCR750M Mat laminaat met versterkte lijmlaag - Laminat mat adh, Renforcé</b> Aanbevolen voor UV afdrukken - Conseillé pour épreuves UV							
70	1,37	50	5	88163109		452,44	6,60
	1,6	50	5	88165266		528,40	6,61



## HYBRID Laminates - Films de Laminations Hybides

Zelfklevende gekalanderde hybride laminaten (transparant)  
Vinyles de pelliculage adhésifs calandrés hybride (transparent)

		Ref. Papyrus	Info	€/roll 	€/m <sup>2</sup> 
--	--	-----------------	------	------------	----------------------

### Hexis V740B Glanzend Laminaat - Laminat Brillant

70	1,05	50		88178790		185,15	3,53
	1,37	50		88178787		241,58	3,53
	1,6	50		88178784		282,13	3,53

## MONOMERIC Laminates - Films de Laminations Monomères

Zelfklevende gekalanderde monomeervinylaminaten (transparant)  
Vinyles de pelliculage adhésifs calandrés monomères (transparent)

### Hexis V700B Glanzend laminaat - Laminat brillant

Aanbevolen voor monomeervinyl, papier en waterbased media  
Conseillé pour vinyle monomère, papier et media à base d'eau

80	1,05	50	3			221,71	4,22
	1,31	50	3			276,61	4,22
	1,37	50	3	88103698		289,32	4,22
	1,6	50	3	88103730		337,89	4,22

### Hexis V700M Mat laminaat - Laminat mat

Aanbevolen voor monomeervinyl, papier en waterbased media  
Conseillé pour vinyle monomère, papier et media à base d'eau

80	1,05	50	3	88103699		221,71	4,22
	1,31	50	3			276,61	4,22
	1,37	50	3	88103700		289,32	4,22
	1,6	50	3	88122091		337,89	4,22

### Hexis V700S Satijn laminaat - Laminat satin

Aanbevolen voor monomeervinyl, papier en waterbased media  
Conseillé pour vinyle monomère, papier et media à base d'eau

80	1,05	50	3	88103731		221,71	4,22
	1,31	50	3			276,61	4,22
	1,37	50	3	88103702		289,32	4,22
	1,6	50	3	88103703		337,89	4,22

## Kit moto PVC Laminates - moto, Quad, Jet-ski Plastification PVC - Kit moto, Quad, Jet-ski

Zelfklevende gekalanderde monomeervinylaminaten (transparant)  
Vinyles de pelliculage adhésifs calandrés monomères (transparent)

### Hexis VRK300B Glanzend laminaat - Laminat brillant

300	1,37	20	3	88186383		360,97	13,17
-----	------	----	---	----------	--	--------	-------

### Hexis VRK300M Mat laminaat - Laminat Mat

300	1,37	20	3	88264902		360,97	13,17
-----	------	----	---	----------	--	--------	-------



## Anti Graffiti Polyester Laminates Films de Laminations Polyester Anti Graffiti

Zelfklevende speciale laminaten (Transparent)  
Films de pelliculage adhésifs spéciaux (Transparent)

				Ref. Papyrus	Info	€/roll 	€/m <sup>2</sup> 
<b>Hexis AG436M Anti-Graffiti Matte anti-graffiti outdoor Polyester - Laminat polyester mat pour application en extérieur</b> Permanente lijm Anti-Graffiti Adhésif Permanent							
30	1,37	50	3	88252782		407,01	5,94
<b>Hexis AG700 Anti-Graffiti Glanzend Polyester - Laminat polyester brillant</b> Permanente lijm - Ook in combinatie met de printfolie Hexis V700 Anti-Graffiti Adhésif Permanent-Aussi en combinaison avec le film d'impression Hexis V700							
36	1,31	50	3	88103686		243,47	3,72
	1,37	50	3	88103687		254,61	3,72
	1,52	50	3			282,35	3,72
<b>Hexis AGCR700 Anti-Graffiti Glanzend Polyester - Laminat polyester brillant</b> Versterkte lijm - Specifiek aangepast laminaat voor Uv prints Colle Renforcée - Particulièrement adapté à la plastification des impressions jet d'encre UV,							
36	1,37	50	3	88161386		281,03	4,10
	1,52	50	3			311,266	4,10
<b>Hexis AG800 Anti-Graffiti and Anti Scratch Glanzend Polyester - Laminat polyester brillant</b> Anti Scratch and anti-Graffiti treatment - Traitement Anti Rayure et Anti Graffiti							
100	1,52	30,5	3	88158406		559,45	12,07



## Floor Laminates Films de laminations pour visuels au sol

### Hexis GFLi 30 Monomeer gestructureerd transparante PVC - PVC transparent monomère structuré

Aanbevolen voor vloerstickers - Antislip R10 - Conseillé pour marquage au sol - Antidérapant R10

130	1,37	30	1	88262834		192,4	4,68
-----	------	----	---	----------	--	-------	------

### Hexis GFLi 170 Monomeer gestructureerd transparante PVC - PVC transparent monomère structuré

Aanbevolen voor vloerstickers - Antislip R09 - Conseillé pour marquage au sol - Antidérapant R09

130	1,37	30	1	88298426		272,21	6,62
-----	------	----	---	----------	--	--------	------

### Hexis GFLX 210 Monomeer gestructureerd transparante PVC - PVC transparent monomère structuré

Aanbevolen voor vloerstickers - Antislip R11 - Conseillé pour marquage au sol - Antidérapant R11

210	1,37	30	1	88250488		228,08	5,55
-----	------	----	---	----------	--	--------	------

### Hexis GFLXR 210 Monomeer gestructureerd transparante PVC - PVC transparent monomère structuré - Colle renforcée

Aanbevolen voor vloerstickers - Antislip R11 - Versterkte lijm - Specifiek aangepast laminaat voor Uv prints - Conseillé pour marquage au sol - Antidérapant R11 - Colle Renforcée - Particulièrement adapté à la plastification des impressions jet d'encre UV,

210	1,37	30	1	88250489		351,23	8,55
-----	------	----	---	----------	--	--------	------

### Hexis GFLX 230 Monomeer gestructureerd transparante PVC - PVC transparent monomère structuré

Aanbevolen voor vloerstickers - Antislip R12 - Conseillé pour marquage au sol - Antidérapant R12

230	1,37	25	1	88298427		603,22	17,61
-----	------	----	---	----------	--	--------	-------

## Hex'Perience - Structurated Laminates Hex'Perience - Film de lamination Structurés

Deze laminaat geeft een realistische, voelbare "structuur" op je printfolie, alsook mogelijk voor effecten op gekleurde folies.

La plastification à effet structurés vous permet de donner d'avantage de réalisme à vos impressions numériques ou vos marquages en films teintés masse.

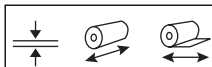

Ref.  
Papyrus

Info



### Hexis Vwood PVC Polymeer laminaat - Plastification PVC polymère structure bois

Foto's (hoge resolutie) van verschillende houtsoorten beschikbaar via: <https://www.hexis-graphics.com/en/hexperience/> - Photo Haute résolution disponible ici : <https://www.hexis-graphics.com/fr/hexperience/>

130	1,37	30	3	88244330		356,83	8,68
-----	------	----	---	----------	--	--------	------

### Hexis PCWALL Gegoten PVC - Lamination PVC Coulée

Mineral wall effect - Effet mur minéral

110	1,37	30	3			713,51	17,36
-----	------	----	---	--	--	--------	-------

### Hexis PCCARBON Gegoten PVC - Lamination PVC Coulée

gloss carbon effect - Effet carbon Brillant

125	1,37	30	3			713,51	17,36
-----	------	----	---	--	--	--------	-------

### Hexis PCGATOR Gegoten PVC - Lamination PVC Coulée

alligator effect - Effet alligator

150	1,37	30	3			713,51	17,36
-----	------	----	---	--	--	--------	-------

### Hexis PCBUSHED Gegoten PVC - Lamination PVC Coulée

brushed aluminium effect - Effet aluminium brossé

110	1,37	30	3			713,51	17,36
-----	------	----	---	--	--	--------	-------



## Hexis PC Star Film de lamination - Effet Pailleté

Existe en 4 coloris : blanc perlé (brillant et satiné), rose royal (brillant), bleu océan (brillant) et jaune luxury (brillant)

		Ref. Papyrus	Info	€/roll	€/m <sup>2</sup>
--	--	-----------------	------	--------	------------------

### Hexis PC Star01G Gegoten PVC - Lamination PVC Coulée

sparkle effect pearl white gloss - effet pailleté blanc perlé brillant

70	1,52	30	3		548	12,02
----	------	----	---	--	-----	-------

### Hexis PC Star01S Gegoten PVC - Lamination PVC Coulée

sparkle effect pearl white satin - effet pailleté blanc perle satin

70	1,52	30	3		548	12,02
----	------	----	---	--	-----	-------

### Hexis PC Star02G Gegoten PVC - Lamination PVC Coulée

sparkle effect royal pink gloss - effet pailleté rose royal brillant

70	1,52	30	3		548	12,02
----	------	----	---	--	-----	-------

### Hexis PC Star03G Gegoten PVC - Lamination PVC Coulée

sparkle effect ocean blue gloss - effet pailleté bleu océan brillant

70	1,52	30	3		548	12,02
----	------	----	---	--	-----	-------

### Hexis PC Star04G Gegoten PVC - Lamination PVC Coulée

sparkle effect luxury yellow gloss - effet pailleté jaune luxury brillant

70	1,52	30	3		548	12,02
----	------	----	---	--	-----	-------

## Laminates for Perforated Window Film Film de lamination pour mirco perforé

Zelfklevende vinyl en polyesterlaminaten specifiek voor toepassing op gaatjesfolie

Vinyles de pelliculage en PVC et polyester, spécifiques pour application sur des films microperforés

### Hexis PC50MCP2 Gegoten PVC - PVC Coulé

Aabevolen voor MICRO2 en MICRO6 - Conseillé pour MICRO2 et MICRO6

50	1,37	30	2	88103693		551,99	13,43
	1,52	30	2			612,55	13,43

### Hexis PG836 Glanzend polyester - Polyester brillant











Aabevolen voor MICRO6 - Conseillé MICRO6

36	1,37	30	2	88103694		299,3	7,28
	1,52	30	2	88103695		332,06	7,28



## STICKYBITS LAMINATES - LAMINATION STICKYBITS MONOMERIC Laminates - Films de Laminations Monomères

Zelfklevende gekalanderde monomeervinylaminaten (transparant)  
 Vinyles de pelliculage adhésifs calandrés monomères (transparent)

					Ref. Papyrus	Info	 €/roll	 €/m <sup>2</sup>
<b>Stickybits Laminate Gloss Glanzend Laminaat - Laminat Brillant</b>								
80	1,04	50					124,80	2,40
	1,3	50		88103722			156,00	2,40
	1,372	50		88113078			164,64	2,40
	1,53	50		88159914			183,60	2,40
<b>Stickybits Laminate Satin Semi glanzend laminaat - Laminat semi-brillant</b>								
80	1,04	50		88103710			124,80	2,40
	1,3	50					156,00	2,40
	1,372	50					164,64	2,40
<b>Stickybits Laminate Matt Mat laminaat - Laminat mat</b>								
80	1,3	50					156,00	2,40
	1,372	50		88103724			164,64	2,40
	1,53	50		88103711			183,60	2,40
<b>Stickybits Laminate Crystal Gestructureerd laminaat - Laminat grainé</b>								
125	0,88	50		88103715			146,40	3,33
	1,04	50		88103716			161,67	3,11
	1,3	50		88103717			202,09	3,11
	1,53	50		88103718			237,85	3,11
<b>Stickybits Certified Non-Slip Floor Laminate Gestructureerd laminaat - Laminat grainé</b>								
125	1,04	50					161,67	3,11
	1,3	50					202,09	3,11
	1,53	50					237,85	3,11

## Polyester Laminates - Films de Laminations Polyester

Optically clear self-adhesive 100% polyester film  
 Film 100% Polyester optiquement clair

Stickybits Optically Clear Self-Adhesive Polyester Film S607 Verwijderbare lijm - Adhésif enlevable

155	1,372	20		88251593			351,24	12,80
-----	-------	----	--	----------	--	--	--------	-------







# STEK CAR PROTECTION FILMS

## FILMS DE PROTECTION STEK POUR VÉHICULE

### STEK PAINT PROTECTION FILM

### Film de protection de Carrosserie STEK

Complete range of Car protection Films  
Gamme complète de film de protection de véhicules

				Ref. Papyrus	Info	€/roll 	€/m <sup>2</sup> 
---	---	---	---	-----------------	------	---	---

#### SteK DYNOSHield Hydrofobic - HYDROphobe® - high gloss - HYDROphobe® - Ultra Brillant,

150	1,524	15	10	88215119		1084	47,42
-----	-------	----	----	----------	--	------	-------

DYNOSHield PAINT PROTECTION FILM (PPF) is a crystal clear PPF using STEK's unique HYDROphobe® top coating to deliver an extremely high gloss, extra durable finish. DYNOSHield's brilliant shine will certainly help maintain that "just waxed" look for your car without you having to apply any wax! HYDROphobe improves contaminant resistance from water marks, insects, bird droppings, road oils, exhaust smoke, and pollutants that can create stains, yellowing, and gloss out on the film's surface. With its excellent "shock-proofing" properties it protects vehicle paint against chipping, scratching, car wash brush marks, etc. HYDROphobe's properties help DYNOSHield provide the highest level of protection available from a paint protection film - Adhesive removable, repositionable, non-yellowing, crystal-clear high performance acrylic adhesive. - DYNOSHield PEINT PROTECTION FILM (PPF) est un film ultra clair utilisant le revêtement supérieur HYDROPHOBE® unique de STEK pour offrir une finition extrêmement brillante et durable. La brillance éclatante de DYNOSHield va certainement aider à maintenir ce look "tout simplement cireux" pour le véhicule sans avoir besoin d'appliquer de la cire! HYDROPHOBE améliore la résistance aux agents extérieurs tels que les marques d'eau, les insectes, les fientes d'oiseaux, les huiles de route, les jaunissements causés par les fumées d'échappement et la pollution. Avec ses excellentes propriétés antichoc, il protège la peinture du véhicule contre les ébréchures, les égratignures, les brosses de lavage de voiture, etc, et permet une auto-cicatrisation contre les rayures minimes. Les propriétés HYDROPHOBE aident DYNOSHield à fournir le plus haut niveau de protection offert par un film de protection de peinture - Adhésif acrylique haute performance amovible, repositionnable, non jaunissant et transparent.

#### SteK DYNOSHield MATT Hydrofobic - HYDROphobe® - satin-finished matte - HYDROphobe® - finition Mat Satinée

150	1,524	15	10	88215120		1220	53,37
-----	-------	----	----	----------	--	------	-------

#### STEK DYNOSHield Carbon - 3D carbon fiber pattern - Motif de Fibre de Carbon 3D

150	1,524	10	10	88272872		942	61,81
-----	-------	----	----	----------	--	-----	-------

Top-Notch technology of 3D carbon fiber coating will give the best performance of top coated PPF in the market and unique style different with other. Specially designed top coating improves contaminant resistance from general PPF such as water marks, insects, bird droppings, road oils, exhaust smoke and pollution caused by yellowing and gloss out on surface. With its excellent shock-proofing properties it protects vehicle paint against chipping, scratches, car wash brushes etc and self healing against tiny scratches. - Adhesive removable, repositionable high performance acrylic, non-yellowing. - La technologie du revêtement imitant la fibre de carbone 3D donnera les meilleures performances et un style unique différent des autres. Le revêtement supérieur spécialement étudié améliore la résistance aux contaminants des PPF généraux tels que les marques d'eau, les insectes, les fientes d'oiseaux, les huiles de route, les jaunissements causés par les fumées d'échappement et la pollution et le lustre sur la surface. Avec ses excellentes propriétés antichoc, il protège la peinture du véhicule contre les ébréchures, les égratignures, les brosses de lavage de voiture, etc, et permet une auto-cicatrisation contre les rayures minimes - Adhésif acrylique haute performance amovible et repositionnable, non jaunissant,

#### STEK DYNOSHade Smoke - Tint Color - Couleur Teintée

150	0,61	15	7	88272879		579	63,28
-----	------	----	---	----------	---	-----	-------

DYNOSHade headlight protection film (HPF) is a colored thermoplastic polyurethane (TPU) film with a special top coat on the surface. It changes the color of the headlight from white to tint color while providing optimal protection for the headlights against water marks, insects, bird droppings, road oils, yellowing caused by smoke and pollution as well as gloss out on the surface. With its excellent shock-proofing properties it protects the headlights against chipping, scratches and car wash brushes. On top of that the DYNOSHade film is self healing quickly from tiny scratches - Adhesive removable, Repositionable high performance acrylic, Non-yellowing. - Le film de protection de phare DYNOSHade (HPF) est un film de polyuréthane thermoplastique (TPU) coloré avec une couche de finition spéciale sur la surface. Il change la couleur du phare du blanc à la teinte tout en offrant une protection optimale pour les phares contre: les traces d'eau, les insectes, les excréments d'oiseaux, les huiles de route, jaunissement causé par la fumée et la pollution. Avec ses excellentes propriétés antichoc, il protège les phares contre les éclats, les rayures et les brosses de lavage de voiture. En plus de cela, le film DYNOSHade auto-cicatrise rapidement les minuscules rayures - Adhésif amovible, Acrylique haute performance repositionnable, Non-jaunissement.

## STEK LIGHT PROTECTION FILM

### Film de Protection de phares STEK

Complete range of Car protection Films  
Gamme complète de film de protection de véhicules

				Ref. Papyrus	Info	€/roll 	€/m <sup>2</sup> 
--	--	--	--	-----------------	------	------------	----------------------

#### STEK DYNO Shade - Smoke Color - Couleur Fumée

150	0,61	15	7	88272878		579	63,28
-----	------	----	---	----------	--	-----	-------

DYNOsmoke headlight protection film (HPF) is a colored thermoplastic polyurethane (TPU) film with a special top coat on the surface. It changes the color of the headlight from white to smoke color while providing optimal protection for the headlights against water marks, insects, bird droppings, road oils, yellowing caused by smoke and pollution as well as gloss out on the surface. With its excellent shock-proofing properties it protects the headlights against chipping, scratches and car wash brushes. On top of that, the DYNOsmoke film is self healing quickly from tiny scratches, - Adhesive removable, Repositionable high performance acrylic, Non-yellowing. - Le film de protection de phare DYNOsmoke (HPF) est un film de polyuréthane thermoplastique coloré (TPU) avec une couche de finition spéciale sur la surface. Il change la couleur du phare du blanc à la couleur fumée tout en offrant une protection optimale pour les phares contre: les traces d'eau, les insectes, les excréments d'oiseaux, les huiles de route, jaunissement causé par la fumée et la pollution. Avec ses excellentes propriétés antichoc, il protège les phares contre les éclats, les rayures et les brosses de lavage de voiture. En plus de cela, le film DYNOshade auto-cicatrise rapidement les minuscules rayures - Adhésif amovible, Acrylique haute performance repositionnable. Non-jaunissement.

#### STEK DYNO Fancy - YellowColor - Couleur Jaune

150	0,61	15	7	88272880		579	63,28
-----	------	----	---	----------	--	-----	-------

DYNOfancy headlight protection film (HPF) is a colored thermoplastic polyurethane (TPU) film with a special top coat on the surface. It changes the color of the headlight from white to yellow color while providing optimal protection for the headlights against water marks, insects, bird droppings, road oils, yellowing caused by smoke and pollution as well as gloss out on the surface. With its excellent shock-proofing properties it protects the headlights against chipping, scratches and car wash brushes. On top of that the DYNOfancy film is self healing quickly from tiny scratches, - Adhesive removable, Repositionable high performance acrylic, Non-yellowing. - Le film de protection de phare DYNOfancy (HPF) est un film de polyuréthane thermoplastique (TPU) coloré avec une couche de finition spéciale sur la surface. Il change la couleur du phare du blanc au jaune tout en offrant une protection optimale pour les phares contre: les traces d'eau, les insectes, les excréments d'oiseaux, les huiles de route, jaunissement causé par la fumée et la pollution. Avec ses excellentes propriétés antichoc, il protège les phares contre les éclats, les rayures et les brosses de lavage de voiture. En plus de cela, le film DYNOshade auto-cicatrise rapidement les minuscules rayures - Adhésif amovible, Acrylique haute performance repositionnable. Non-jaunissement.

## STEK WINDSHIELD PROTECTION FILM

### Film de Protection de parebrise STEK

Complete range of Car protection Films  
Gamme complète de film de protection de véhicules

				Ref. Papyrus	Info	€/roll 	€/m <sup>2</sup> 
--	--	--	--	-----------------	------	------------	----------------------

#### STEK OPTIX Shield - gloss windshield protective film - film protecteur de pare-brise brillant







120	1,22	30	1	88273021		942,03	25,74
-----	------	----	---	----------	--	--------	-------

OPTIXshield provides you with the best clarity in any windshield protection film, while adding extra protection from chips, scratches, webs, and pitting. Our superior top coat technology is among the highest in scratch resistance, even with daily wear from nature's toughest elements and the constant action of windshield wipers. Unparalleled levels of clarity ensures that your vision remains unimpaired, with minimal light refraction and distortion from any angle. Increase visibility by having faster runoffs from rain, snow, and contaminants as the film drastically decreases the surface tension on the windshield, OPTIXshield also blocks over 99% of harmful UV rays to protect your car's interior and passengers. unimpaired, with minimal light refraction and distortion from any angle, Increase visibility by having faster runoffs from rain, snow, and contaminants as the film drastically decreases the surface tension on the windshield. - OPTIXshield also blocks over 99% of harmful UV rays to protect your car's interior and passengers, - OPTIXshield offre la meilleure clarté dans tout film de protection de pare-brise, tout en ajoutant une protection supplémentaire contre les éclats, les rayures, les traces. La technologie supérieure de la couche de finition est parmi les plus résistantes aux rayures, même avec l'usure quotidienne des éléments les plus durs de la nature et l'action constante des essuie-glaces. Des niveaux de clarté inégalés garantissent que la vision reste intacte, avec une réfraction de la lumière minimale et une distorsion de tous les angles, Augmente la visibilité en créant des écoulements plus rapides de la pluie, de la neige et des contaminants, car le film diminue considérablement la tension de surface sur le pare-brise. OPTIXshield bloque également plus de 99% des rayons UV nocifs afin de protéger l'intérieur et les passagers de la voiture.

## Automotive Scorpion Window film Film Scorpion pour vitrage de véhicule.

Scorpion getinte raamfolies zijn de volgende evolutie van hightech UV-bescherming voor voertuigen. Scorpion films buigen het zonlicht af, maar blokkeren ook 99% van de schadelijke UV-stralen van de zon en bieden een uitstekende bescherming voor uw huid. Met Scorpion-auroruitintfilms krijgt u levenslange bescherming tegen verblinding en schade aan het interieur van het voertuig.

Les films teintés pour vitres Scorpion sont la prochaine évolution de la protection UV de haute technologie pour les véhicules. Les film Scorpion dévient la lumière du soleil, mais bloque aussi 99% des rayons UV nocifs du soleil, offrant ainsi une excellente protection pour votre peau. Avec les films teintés pour vitres de voiture Scorpion, vous obtiendrez une protection à vie contre l'éblouissement et la dégradation de l'intérieur du véhicule.

				Ref. Papyrus	Info	€/roll 	€/m <sup>2</sup> 
---	---	---	---	-----------------	------	---	---

### Scorpion Predator Dyed 05

De Predator-serie heeft een 38µ dubbellaagse constructie. Een niet-reflecterende en stabiele kleurenfilm die een grote optische helderheid biedt. Predator biedt installateur en consument een keuze die een leven lang meegaat. Beschikbaar in 6 tinten. - La série Predator présente une construction à double couche de 38µ. Un film non réfléchissant et stable en couleur qui offre une grande clarté optique. Predator offre à l'installateur et au consommateur un choix qui durera toute une vie. Disponible en 6 teintes.

38	0,61	30,5	1	88316297	206,22	11,08
	0,914	30,5	1	88316298	282,67	10,14

### Scorpion Predator Dyed 20

De Predator-serie heeft een 38µ dubbellaagse constructie. Een niet-reflecterende en stabiele kleurenfilm die een grote optische helderheid biedt. Predator biedt installateur en consument een keuze die een leven lang meegaat. Beschikbaar in 6 tinten. - La série Predator présente une construction à double couche de 38µ. Un film non réfléchissant et stable en couleur qui offre une grande clarté optique. Predator offre à l'installateur et au consommateur un choix qui durera toute une vie. Disponible en 6 teintes.

38	0,61	30,5	1	88316299	206,22	11,08
	0,914	30,5	1	88316300	282,67	10,14

### Scorpion Carbon 70

De Carbon-serie heeft een dubbele laagconstructie van 38µ. Uitgerust met stabiele koolstofafzettingstechnologie in kleur, biedt de Carbon-serie een verhoogde bescherming tegen verkleuring terwijl de warmtewering wordt verhoogd. Beschikbaar in 6 tinten - La série Carbon présente une construction à double couche de 38µ. Équipée de la technologie de dépôt de carbone à couleur stable, la série Carbon offre une protection accrue contre la décoloration tout en augmentant le rejet de chaleur. Disponible en 6 teintes.

38	0,61	30,5	1	88316301	151,67	8,15
	0,914	30,5	1	88316302	252,25	9,05

# Papyrus Viscom

Prijslijst / Liste de prix  
Rigid Media

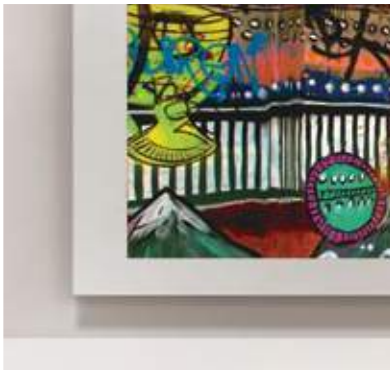

**PAPYRUS**   
Your partner in Visual Communication



# Rigid Media

## CHROMALUXE ALUMINIUM - Aluminium CHROMALUXE

Aluminium Photo Panel: Gloss White - 1 Side / Blanc Brillant - 1 Face / 1,14 mm. . . . .	.161
Aluminium Photo Panel: Gloss White - 1 Side / Blanc Brillant - 1 Face / 1,14 mm. . . . .	.162
Aluminium Business cards: Gloss White - 2 Sides / Blanc Brillant - 2 Faces / 1,14 mm. . . . .	.162
Aluminium Photo Panel: Semi Gloss White - 1 Side / Blanc Semi Brillant - 1 Face / 1,14 mm. . . . .	.162
Aluminium Photo Panel: Matte White - 1 Side / Blanc Mat - 1 Face / 1,14 mm. . . . .	.163
Aluminium Photo Panel: Gloss Clear - 1 Side / Naturel Brillant - 1 Face / 1,14 mm. . . . .	.163
Aluminium Photo Panel: Gloss Clear - 1 Side / Naturel Brillant - 1 Face / 1,14 mm. . . . .	.164
Aluminium Photo Panel: Semi Gloss Clear - 1 Side / Naturel Semi Brillant - 1 Face / 1,14 mm.. . . .	.164
Aluminium Photo Panel: Matte Clear - 1 Side / Naturel Mat - 1 Face / 1,14 mm. . . . .	.165
Aluminium Photo Creative Border Panel: Gloss White - 1 Side / Blanc Brillant - 1 Face / mm. . . . .	.165
Aluminium Photo Creative Border Panel: Gloss White - 1 Side / Blanc Brillant - 1 Face / 1,14 mm.. . . .	.165

## CHROMALUXE ALUMINUM Extended - Aluminium CHROMALUXE pour l'EXTÉRIEUR

Aluminium Extended Panels: Metal Panel Gloss White - 1 Side / Panneau Métallique Blanc Brillant - 1 Face / 1,14 mm. . . . .	.166
---	------

## CHROMALUXE Wood Panel MDF - Panneau de bois MDF CHROMALUXE

Regular MDF: Gloss White - 1 Side - Black Back / Blanc brillant simple Face - Dos Noir / 16 mm. . . . .	.167
---	------

## CHROMALUXE MAPLE VENEER/MDF - Mdf Placage érable CHROMALUXE

Natural Wood Panel: Maple Matte Clear VNR - 1 side / Erable Mat Clair - 1 Face / 16 mm. . . . .	.168
---	------

## CHROMALUXE Moisture Resistant MDF - Panneau de bois MDF CHROMALUXE résistant à l'Humidité

Moisture Resistant MDF - Table Top: Semi Gloss White - 1 Side - Clear Back / Blanc Semi brillant simple Face - Dos naturel / mm. .168	.168
---	------

## CHROMALUXE HARDBOARD - Panneaux HDF Chromaluxe

Hardboard Photo Panels with easel - Flat Top: Gloss White - 1 Side - Black Back / Blanc brillant simple Face - Dos Noir / mm. . . . .	.169
Photo Panels with easel - Arch Top: Gloss White - 1 Side - Black Back / Blanc brillant simple Face - Dos Noir / 6,35 mm. . . . .	.169

## CHROMALUXE HARDBOARD - Panneaux HDF Chromaluxe

Photo Panels with KickStand - Flat Top: Gloss White - 1 Side - Black Back / Blanc brillant simple Face - Dos Noir / 6,35 mm. . . . .	.170
Hinged Desktop Photo Panels - Vertical Flat Top: Gloss White - 1 Side - Black Back / Blanc brillant simple Face - Dos Noir / 6,35 mm.170	.170
Hinged Desktop panels - Vertical Arch Top: Gloss White - 1 Side - Black Back / Blanc brillant simple Face - Dos Noir / 6,35 mm. . . . .	.170

## CHROMALUXE Steel - Acier CHROMALUXE

Steel Panel: Steel Gloss White - 1 Side / Acier Blanc Brillant - 1 Face / 0,58 mm. . . . .	.170
--	------

## UNISUB ALUMINIUM - Aluminium UNISUB

Aluminium Photo Panel: Gloss White - 1 Side / Blanc Brillant - 1 Face / 0,75 mm. . . . .	.171
Aluminium Photo Panel: Gloss White - 2 Sides / Blanc Brillant - 2 Faces / 1,14 mm. . . . .	.171
Aluminium Photo Panel: Gloss Clear - 1 Side / Naturel Brillant - 1 Face / 0,75 mm. . . . .	.171
Aluminium Photo Panel: Matte White - 1 Side / Blanc Mat - 1 Face / 0,75 mm. . . . .	.171
Aluminium Photo Panel: Semi Gloss White - 1 Side / Blanc Semi Brillant - 1 Face / 0,75 mm. . . . .	.171

## UNISUB ALUMINIUM - Aluminium UNISUB

Aluminium Clocks: White - 1 Side / brillant - simple Face / mm. . . . .	.172
Aluminium Business cards: Gloss White - 2 Sides / Blanc Brillant - 2 Faces / mm. . . . .	.172
Aluminium Name Badges: Gloss Clear - 1 Side / Naturel Brillant - 1 Face / mm.. . . .	.172

## UNISUB ALUMINIUM - Aluminium UNISUB

Aluminium Name Badges: Gloss White - 1 Side / Blanc Brillant - 1 Face / mm. . . . .	.173
Aluminium Name Badges: Matt White - 1 Side / Blanc Mat - 1 Face / mm. . . . .	.173

## UNISUB ALUMINIUM - Aluminium UNISUB

Aluminium Magnets: Semi Gloss White - 1 Side / Blanc Semi Brillant - 1 Face / mm. . . . .	.174
Aluminium Magnets: Gloss White - 1 Side / Blanc Brillant - 1 Face / mm. . . . .	.174

## UNISUB HARDBOARD - Panneaux HDF UNISUB

Hardboard Panels: Gloss White - 1 Side - Black Back / Blanc brillant - simple Face / 3,18 mm. . . . .	.175
Hardboard Panels: Gloss White - 2 Sides - Black Back / Blanc brillant - Double Face / 3,18 mm. . . . .	.175
Hardboard Panels: Matt White - 1 Side - Black Back / Blanc Mat - simple Face / 3,18 mm.. . . .	.175
Hardboard Panels: Gloss White - 1 Side - Black Back / Blanc brillant - simple Face / 6 mm.. . . .	.175
Clocks: Gloss White - 1 Side - Black Edges / Blanc brillant - simple Face - Bords Noirs / mm. . . . .	.175

## UNISUB HARDBOARD - Panneaux HDF UNISUB

Coasters with cork back: Gloss White - 1 Side - Black Back / Blanc brillant - simple Face / mm. . . . .	.176
Coasters with raw back: Gloss White - 1 Side - Black Back / Blanc brillant - simple Face / mm. . . . .	.176
Clipboards: Gloss White - 2 Sides / Blanc brillant double Faces / mm.. . . .	.176

## UNISUB HARDBOARD - Panneaux HDF UNISUB

Serving Trays - Natural wood: Gloss White - 1 Side / Blanc brillant - simple Face / mm. . . . .	.177
Serving Trays - ESPRESSO BLACK: Gloss White - 1 Side / Blanc brillant - simple Face / mm. . . . .	.177

## UNISUB HARDBOARD - Panneaux HDF UNISUB

Puzzles: Gloss White - 1 Side / Blanc brillant - simple Face / mm. . . . .	.178
Picture Frame: Gloss White - 1 Side - Black edges / Blanc brillant - simple Face - Bords Noirs / mm.. . . .	.178
Message Board: Gloss White - 1 Side - Black Edges / Blanc brillant - simple Face - Bords Noirs / mm. . . . .	.178

## UNISUB Wood Panel MDF - Panneau de bois MDF UNISUB

Regular MDF 19 mm. Plate: Gloss White - 1 Side - Black Back / Blanc brillant simple Face - Dos Noir / 19 mm. . . . .	.179
Cherry Ogee Edge Plaques: Gloss White - 1 Side - w/Cherry Edge / Blanc brillant simple Face - Avec Bord Merisier / mm. . . . .	.179
Black Ogee Edge Plaques: Gloss White - 1 Side - w/Black Edge / Blanc brillant simple Face - Avec Bord Noir / mm. . . . .	.179

## UNISUB Wood Panel MDF - Panneau de bois MDF UNISUB

Flat Edge / Extra Large / Clock Plaque : Gloss White - 1 Side - w/Black Edge / Blanc brillant simple Face - Avec Bord Noir / mm..	.180
Specialty Shaped Plaques: Gloss White - 1 Side - w/Black Edge / Blanc brillant simple Face - Avec Bord Noir / mm. . . . .	.180

## UNISUB Steel Panel - Panneaux Acier UNISUB

Steel Panel: Steel Gloss White - 1 Side / Acier Blanc Brillant - 1 Face / 0,58 mm. . . . .	.180
--	------

## PVC - PVC

Transparent - Transparent . . . . .	.181
Transparent Anti-Reflect - Transparent Anti-Reflet . . . . .	.181
White Gloss - Blanc Brillant . . . . .	.181
White Matt - Blanc Mat . . . . .	.181

## PET GAG - PET GAG

Transparent - Transparent . . . . .	.181
-------------------------------------	------

## POLYSTYRENE - POLYSTYRENE

White Matt/Matt - Blanc Mat/Mat . . . . .	.181
---	------

## POLYPROP CORRUGATED - POLYPROPYLENE ALVEOLAIRE

BIPROPB White - BIPROPB Blanc . . . . .	.182
BI-SQUARE White - BI-SQUARE Blanc . . . . .	.182
BI-SQUARE Yellow - BI-SQUARE Jaune . . . . .	.182





## CHROMALUXE ALUMINIUM - Aluminium CHROMALUXE

Aluminum panels are lightweight, durable, made with recycled material and 100% recyclable. They are the perfect medium for displaying artwork and photography in a variety of applications from residential to commercial usage. Les panneaux d'aluminium sont légers, durables, faits de matériaux recyclés et recyclables à 100%. Ils sont le moyen idéal pour afficher des œuvres d'art et de la photographie dans une variété d'applications d'usage résidentiel à commercial.





Description	mm.	mm.	Supplier Ref.	Papyrus Ref.	Info	€/Pack
<b>Aluminium Photo Panel: Gloss White - 1 Side / Blanc Brillant - 1 Face / 1,14 mm.</b>						
Chromaluxe Aluminium Gloss White - 1200 x 2400 mm (Full sheet)	1200	2400	9400	88274819	-	253,06
Chromaluxe Aluminium Gloss White - 1200 x 1200 mm (Half sheet)	1200	1200	7380	88274857	-	132,86
Chromaluxe Aluminium Gloss White - 1200 x 600 mm (Quarter sheet)	1200	600	7382	88274859	-	69,75
Chromaluxe Aluminium Gloss White - 51 x 76 mm (50 pcs)	50,8	76,2	4308	88274860	-	60,00
Chromaluxe Aluminium Gloss White - 100 x 150 mm (10 pcs)	100	150	3043	88274868	-	41,88
Chromaluxe Aluminium Gloss White - 102 x 102 mm (10 pcs)	101,6	101,6	4302	88274870	-	30,48
Chromaluxe Aluminium Gloss White - 102 x 152 mm (10 pcs)	101,6	152,4	4113	88274872	-	42,00
Chromaluxe Aluminium Gloss White - 127 x 127 mm (10 pcs)	127	127	4294	88274877	-	42,96
Chromaluxe Aluminium Gloss White - 127 x 178 mm (10 pcs)	127	177,8	4054	88274878	-	47,76
Chromaluxe Aluminium Gloss White - 127 x 254 mm (10 pcs)	127	254	4114	88274879	-	62,64
Chromaluxe Aluminium Gloss White - 127 x 279 mm (10 pcs)	127	279,4	4295	88274880	-	63,48
Chromaluxe Aluminium Gloss White - 127 x 432 mm (10 pcs)	127	431,8	4296	88274882	-	87,36
Chromaluxe Aluminium Gloss White - 150 x 150 mm (10 pcs)	150	150	3044	88274883	-	47,04
Chromaluxe Aluminium Gloss White - 150 x 200 mm (10 pcs)	150	200	3014	88274884	-	51,00
Chromaluxe Aluminium Gloss White - 152 x 152 mm (10 pcs)	152,4	152,4	4066	88274885	-	47,76
Chromaluxe Aluminium Gloss White - 180 x 270 mm (10 pcs)	180	270	3045	88274890	-	64,92
Chromaluxe Aluminium Gloss White - 200 x 300 mm (10 pcs)	200	300	3017	88274891	-	85,92
Chromaluxe Aluminium Gloss White - 203 x 203 mm (10 pcs)	203,2	203,2	4071	88274892	-	71,28
Chromaluxe Aluminium Gloss White - 203 x 254 mm (10 pcs)	203,2	254	5881	88274893	-	72,96
Chromaluxe Aluminium Gloss White - 203 x 305 mm (10 pcs)	203,2	304,8	4130	88274894	-	84,36
Chromaluxe Aluminium Gloss White - 229 x 533 mm (10 pcs)	228,6	533,4	4067	88274895	-	163,92
Chromaluxe Aluminium Gloss White - 240 x 360 mm (10 pcs)	240	360	3046	88274896	-	110,28
Chromaluxe Aluminium Gloss White - 254 x 254 mm (10 pcs)	254	254	4072	88274897	-	102,12
Chromaluxe Aluminium Gloss White - 254 x 508 mm (10 pcs)	254	508	4116	88274898	-	180,48
Chromaluxe Aluminium Gloss White - 254 x 762 mm (10 pcs)	254	762	4273	88274900	-	308,04
Chromaluxe Aluminium Gloss White - 279 x 279 mm (10 pcs)	279,4	279,4	4297	88274902	-	103,92
Chromaluxe Aluminium Gloss White - 279 x 356 mm (10 pcs)	279,4	355,6	5882	88274904	-	121,56
Chromaluxe Aluminium Gloss White - 279 x 432 mm (10 pcs)	279,4	431,8	4287	88274906	-	161,88
Chromaluxe Aluminium Gloss White - 291 x 291 mm (10 pcs)	291	291	3047	88274909	-	104,40
Chromaluxe Aluminium Gloss White - 298 x 298 mm (10 pcs)	298,4	298,4	4059	88274910	-	105,12
Chromaluxe Aluminium Gloss White - 300 x 300 mm (10 pcs)	300	300	3020	88274913	-	105,12
Chromaluxe Aluminium Gloss White - 300 x 400 mm (10 pcs)	300	400	3023	88274916	-	135,84
Chromaluxe Aluminium Gloss White - 305 x 305 mm (10 pcs)	304,8	304,8	4115	88274920	-	105,36
Chromaluxe Aluminium Gloss White - 305 x 457 mm (10 pcs)	304,8	457,2	4131	88274921	-	175,80
Chromaluxe Aluminium Gloss White - 305 x 610 mm (10 pcs)	304,8	609,6	4118	88274922	-	205,44
Chromaluxe Aluminium Gloss White - 356 x 457 mm (10 pcs)	355,6	457,2	4111	88274924	-	202,56
Chromaluxe Aluminium Gloss White - 381 x 381 mm (10 pcs)	381	381	4183	88274925	-	188,88
Chromaluxe Aluminium Gloss White - 381 x 476 mm (10 pcs)	381	476,2	4020	88274926	-	216,84



## CHROMALUXE ALUMINIUM - Aluminium CHROMALUXE

Description			Supplier Ref.	Papyrus Ref.	Info	€/Pack
<b>Aluminium Photo Panel: Gloss White - 1 Side / Blanc Brillant - 1 Face / 1,14 mm.</b>						
Chromaluxe Aluminium Gloss White - 400 x 600 mm (10 pcs)	400	600	3050	88274927	-	290,14
Chromaluxe Aluminium Gloss White - 406 x 406 mm (10 pcs)	406,4	406,4	4117	88274928	-	224,40
Chromaluxe Aluminium Gloss White - 406 x 508 mm (10 pcs)	406,4	508	4016	88274930	-	276,28
Chromaluxe Aluminium Gloss White - 406 x 610 mm (10 pcs)	406,4	609,6	4129	88274931	-	375,01
Chromaluxe Aluminium Gloss White - 406 x 813 mm (10 pcs)	406,4	812,8	4132	88274971	-	554,80
Chromaluxe Aluminium Gloss White - 457 x 914 mm (10 pcs)	457,2	914,4	4133	88274973	-	654,72
Chromaluxe Aluminium Gloss White - 500 x 500 mm (10 pcs)	500	500	3049	88274974	-	385,57
Chromaluxe Aluminium Gloss White - 508 x 508 mm (10 pcs)	508	508	4119	88274975	-	385,57
Chromaluxe Aluminium Gloss White - 508 x 610 mm (10 pcs)	508	609,6	4120	88274977	-	396,13
Chromaluxe Aluminium Gloss White - 508 x 762 mm (10 pcs)	508	762	4069	88274979	-	509,26
Chromaluxe Aluminium Gloss White - 600 x 800 mm (10 pcs)	600	800	3052	88274980	-	525,36
Chromaluxe Aluminium Gloss White - 610 x 610 mm (10 pcs)	609,6	609,6	4121	88274983	-	428,47
Chromaluxe Aluminium Gloss White - 610 x 660 mm (10 pcs)	609,6	660,4	4068	88274985	-	517,31
Chromaluxe Aluminium Gloss White - 610 x 762 mm (10 pcs)	609,6	762	4122	88274987	-	525,36
Chromaluxe Aluminium Gloss White - 610 x 914 mm (10 pcs)	609,6	914,4	4123	88274988	-	773,52
Chromaluxe Aluminium Gloss White - 700 x 700 mm (10 pcs)	700	700	3051	88274991	-	978,12
Chromaluxe Aluminium Gloss White - 700 x 1000 mm (10 pcs)	700	1000	3053	88274992	-	983,80
Chromaluxe Aluminium Gloss White - 762 x 762 mm (10 pcs)	762	762	4280	88274993	-	965,58
Chromaluxe Aluminium Gloss White - 762 x 1016 mm (10 pcs)	762	1016	4125	88274995	-	983,00
Chromaluxe Aluminium Gloss White - 813 x 1016 mm (9 pcs)	812,8	1016	5909	88274996	-	894,81
Chromaluxe Aluminium Gloss White - 914 x 914 mm (6 pcs)	914,4	914,4	5910	88274997	-	793,22
Chromaluxe Aluminium Gloss White - 1016 x 1524 mm (3 pcs)	1016	1524	5912	88274998	-	665,50
Chromaluxe Aluminium Gloss White - 1219 x 1219 mm (6 pcs)	1219,2	1219,2	5911	88275001	-	901,61
<b>Aluminium Business cards: Gloss White - 2 Sides / Blanc Brillant - 2 Faces / 1,14 mm.</b>						
GW - Alu. Photo Panel - Business Card 2 Side - 51 x 89 mm (50 pcs)	51	89	4329		-	50 78,25
<b>Aluminium Photo Panel: Semi Gloss White - 1 Side / Blanc Semi Brillant - 1 Face / 1,14 mm.</b>						
Chromaluxe Aluminium Semi-Gloss White - 1200 x 2400 mm (Full sheet)	1200	2400	9402	88275006	-	278,37
Chromaluxe Aluminium Semi-Gloss White - 1200 x 1200 mm (Half sheet)	1200	1200	8831	88275008	-	146,14
Chromaluxe Aluminium Semi-Gloss White - 1200 x 600 mm (Quarter sheet)	1200	600	9584	88275010	-	76,72
Chromaluxe Aluminium Semi-Gloss White - 102 x 102 mm (10 pcs)	101,6	101,6	4549	88275012	-	25,15
Chromaluxe Aluminium Semi-Gloss White - 127 x 178 mm (10 pcs)	127	177,8	4550	88275014	-	52,54
Chromaluxe Aluminium Semi-Gloss White - 150 x 150 mm (10 pcs)	150	150	3114	88275015	-	41,39
Chromaluxe Aluminium Semi-Gloss White - 150 x 200 mm (10 pcs)	150	200	3115	88275016	-	56,10
Chromaluxe Aluminium Semi-Gloss White - 200 x 300 mm (10 pcs)	200	300	3116	88275020	-	94,51
Chromaluxe Aluminium Semi-Gloss White - 203 x 254 mm (10 pcs)	203,2	254	4551	88275021	-	80,26
Chromaluxe Aluminium Semi-Gloss White - 203 x 305 mm (10 pcs)	203,2	304,8	4552	88275024	-	92,80
Chromaluxe Aluminium Semi-Gloss White - 279 x 356 mm (10 pcs)	279,4	355,6	4553	88275027	-	133,72
Chromaluxe Aluminium Semi-Gloss White - 300 x 300 mm (10 pcs)	300	300	3117	88275029	-	115,63
Chromaluxe Aluminium Semi-Gloss White - 300 x 400 mm (10 pcs)	300	400	3118	88275031	-	149,42
Chromaluxe Aluminium Semi-Gloss White - 305 x 457 mm (10 pcs)	304,8	457,2	4554	88275032	-	193,38
Chromaluxe Aluminium Semi-Gloss White - 400 x 600 mm (10 pcs)	400	600	3119	88275035	-	290,14
Chromaluxe Aluminium Semi-Gloss White - 406 x 508 mm (10 pcs)	406,4	508	4555	88275036	-	276,28
Chromaluxe Aluminium Semi-Gloss White - 406 x 610 mm (10 pcs)	406,4	609,6	4556	88275037	-	375,01
Chromaluxe Aluminium Semi-Gloss White - 500 x 500 mm (10 pcs)	500	500	3120	88275041	-	385,57
Chromaluxe Aluminium Semi-Gloss White - 508 x 762 mm (10 pcs)	508	762	4557	88275044	-	509,26
Chromaluxe Aluminium Semi-Gloss White - 600 x 800 mm (10 pcs)	600	800	3121	88275046	-	525,36
Chromaluxe Aluminium Semi-Gloss White - 700 x 1000 mm (10 pcs)	700	1000	3122	88275068	-	983,80
Chromaluxe Aluminium Semi-Gloss White - 762 x 1016 mm (10 pcs)	762	1016	4558	88275047	-	983,00
Chromaluxe Aluminium Semi-Gloss White - 1016 x 1524 mm (3 pcs)	1016	1524	4559	88275070	-	665,50

## CHROMALUXE ALUMINIUM - Aluminium CHROMALUXE



Description	 mm.	 mm.	Supplier Ref.	Papyrus Ref.	Info	€/Pack
<b>Aluminium Photo Panel: Matte White - 1 Side / Blanc Mat - 1 Face / 1,14 mm.</b>						
Chromaluxe Aluminium Matte White - 1200 x 2400 mm (Full sheet)	1200	2400	9401	88275074	-	278,37
Chromaluxe Aluminium Matte White - 1200 x 1200 mm (Half sheet)	1200	1200	7381	88275075	-	146,14
Chromaluxe Aluminium Matte White - 1200 x 600 mm (Quarter sheet)	1200	600	7116	88275076	-	76,72
Chromaluxe Aluminium Matte White - 100 x 150 mm (10 pcs)	100	150	3063	88275088	-	36,85
Chromaluxe Aluminium Matte White - 102 x 102 mm (10 pcs)	101,6	101,6	4304	88275089	-	25,15
Chromaluxe Aluminium Matte White - 127 x 178 mm (10 pcs)	127	177,8	4055	88275103	-	52,54
Chromaluxe Aluminium Matte White - 150 x 150 mm (10 pcs)	150	150	3064	88275108	-	41,39
Chromaluxe Aluminium Matte White - 150 x 200 mm (10 pcs)	150	200	3015	88275111	-	56,10
Chromaluxe Aluminium Matte White - 180 x 270 mm (10 pcs)	180	270	3065	88275117	-	91,30
Chromaluxe Aluminium Matte White - 200 x 300 mm (10 pcs)	200	300	3018	88275119	-	94,51
Chromaluxe Aluminium Matte White - 203 x 254 mm (10 pcs)	203,2	254	4008	88275125	-	80,26
Chromaluxe Aluminium Matte White - 240 x 360 mm (10 pcs)	240	360	3066	88275130	-	121,31
Chromaluxe Aluminium Matte White - 279 x 356 mm (10 pcs)	279,4	355,6	4009	88275215	-	133,72
Chromaluxe Aluminium Matte White - 291 x 291 mm (10 pcs)	291	291	3067	88275218	-	114,84
Chromaluxe Aluminium Matte White - 298 x 298 mm (10 pcs)	298,4	298,4	4063	88275219	-	115,63
Chromaluxe Aluminium Matte White - 300 x 300 mm (10 pcs)	300	300	3021	88275220	-	115,63
Chromaluxe Aluminium Matte White - 300 x 400 mm (10 pcs)	300	400	3024	88275221	-	149,42
Chromaluxe Aluminium Matte White - 305 x 610 mm (10 pcs)	304,8	609,6	4283	88275222	-	177,54
Chromaluxe Aluminium Matte White - 400 x 600 mm (10 pcs)	400	600	3072	88275223	-	290,14
Chromaluxe Aluminium Matte White - 406 x 508 mm (10 pcs)	406,4	508	4018	88275224	-	276,28
Chromaluxe Aluminium Matte White - 500 x 500 mm (10 pcs)	500	500	3071	88275225	-	385,57
Chromaluxe Aluminium Matte White - 600 x 800 mm (10 pcs)	600	800	3110	88275226	-	525,36
Chromaluxe Aluminium Matte White - 700 x 1000 mm (10 pcs)	700	1000	3073	88275228	-	983,80
<b>Aluminium Photo Panel: Gloss Clear - 1 Side / Naturel Brillant - 1 Face / 1,14 mm.</b>						
Chromaluxe Aluminium Gloss Clear - 1200 x 2400 mm (Full sheet)	1200	2400	9403	88275229	-	278,37
Chromaluxe Aluminium Gloss Clear - 1200 x 1200 mm (Half sheet)	1200	1200	7379	88275231	-	146,14
Chromaluxe Aluminium Gloss Clear - 1200 x 600 mm (Quarter sheet)	1200	600	6529	88275232	-	76,72
Chromaluxe Aluminium Gloss Clear - 102 x 102 mm (10 pcs)	101,6	101,6	4303	88275238	-	25,15
Chromaluxe Aluminium Gloss Clear - 102 x 152 mm (10 pcs)	101,6	152,4	4252	88275239	-	36,96
Chromaluxe Aluminium Gloss Clear - 127 x 127 mm (10 pcs)	127	127	4298	88275242	-	35,44
Chromaluxe Aluminium Gloss Clear - 127 x 178 mm (10 pcs)	127	177,8	4056	88275249	-	52,54
Chromaluxe Aluminium Gloss Clear - 127 x 254 mm (10 pcs)	127	254	4260	88275250	-	68,90
Chromaluxe Aluminium Gloss Clear - 127 x 279 mm (10 pcs)	127	279,4	4299	88275253	-	69,83
Chromaluxe Aluminium Gloss Clear - 127 x 432 mm (10 pcs)	127	431,8	4300	88275256	-	96,10
Chromaluxe Aluminium Gloss Clear - 150 x 150 mm (10 pcs)	150	150	3102	88275259	-	41,39
Chromaluxe Aluminium Gloss Clear - 150 x 200 mm (10 pcs)	150	200	3016	88275266	-	56,10
Chromaluxe Aluminium Gloss Clear - 152 x 152 mm (10 pcs)	152,4	152,4	4255	88275268	-	42,03
Chromaluxe Aluminium Gloss Clear - 200 x 300 mm (10 pcs)	200	300	3019	88275292	-	94,51
Chromaluxe Aluminium Gloss Clear - 203 x 203 mm (10 pcs)	203,2	203,2	4182	88275293	-	78,41
Chromaluxe Aluminium Gloss Clear - 203 x 254 mm (10 pcs)	203,2	254	5996	88275294	-	80,26
Chromaluxe Aluminium Gloss Clear - 203 x 305 mm (10 pcs)	203,2	304,8	4135	88275295	-	92,80
Chromaluxe Aluminium Gloss Clear - 229 x 533 mm (10 pcs)	228,6	533	4259	88275296	-	180,31
Chromaluxe Aluminium Gloss Clear - 254 x 254 mm (10 pcs)	254	254	4254	88275297	-	112,33
Chromaluxe Aluminium Gloss Clear - 254 x 508 mm (10 pcs)	254	508	4253	88275298	-	198,53
Chromaluxe Aluminium Gloss Clear - 254 x 762 mm (10 pcs)	254	762	4274	88275306	-	308,40
Chromaluxe Aluminium Gloss Clear - 279 x 279 mm (10 pcs)	279,4	279,4	4301	88275309	-	114,31
Chromaluxe Aluminium Gloss Clear - 279 x 356 mm (10 pcs)	279,4	355,6	5997	88275310	-	133,72
Chromaluxe Aluminium Gloss Clear - 279 x 432 mm (10 pcs)	279,4	431,8	4288	88275315	-	178,07
Chromaluxe Aluminium Gloss Clear - 298 x 298 mm (10 pcs)	298,4	298,4	4065	88275317	-	115,63
Chromaluxe Aluminium Gloss Clear - 300 x 300 mm (10 pcs)	300	300	3022	88275321	-	115,63

## CHROMALUXE ALUMINIUM - Aluminium CHROMALUXE

Description			Supplier Ref.	Papyrus Ref.	Info	€/Pack
<b>Aluminium Photo Panel: Gloss Clear - 1 Side / Naturel Brillant - 1 Face / 1,14 mm.</b>						
Chromaluxe Aluminium Gloss Clear - 300 x 400 mm (10 pcs)	300	400	3025	88275323	-	149,42
Chromaluxe Aluminium Gloss Clear - 305 x 305 mm (10 pcs)	304,8	304,8	4256	88275325	-	115,90
Chromaluxe Aluminium Gloss Clear - 305 x 457 mm (10 pcs)	304,8	457,2	4136	88275328	-	193,38
Chromaluxe Aluminium Gloss Clear - 305 x 610 mm (10 pcs)	304,8	609,6	4257	88275330	-	225,98
Chromaluxe Aluminium Gloss Clear - 305 x 610 mm (10 pcs)	304,8	609,6	4284	88275331	-	177,54
Chromaluxe Aluminium Gloss Clear - 381 x 476 mm (10 pcs)	381	476,2	4021	88275336	-	238,52
Chromaluxe Aluminium Gloss Clear - 400 x 600 mm (10 pcs)	400	600	3108	88275337	-	290,14
Chromaluxe Aluminium Gloss Clear - 406 x 406 mm (10 pcs)	406,4	406,4	4258	88275349	-	224,40
Chromaluxe Aluminium Gloss Clear - 406 x 508 mm (10 pcs)	406,4	508	4017	88275351	-	276,28
Chromaluxe Aluminium Gloss Clear - 406 x 610 mm (10 pcs)	406,4	609,6	4134	88275352	-	375,01
Chromaluxe Aluminium Gloss Clear - 406 x 813 mm (10 pcs)	406,4	812,8	4137	88275353	-	504,36
Chromaluxe Aluminium Gloss Clear - 457 x 914 mm (10 pcs)	457,2	914,4	4138	88275354	-	595,20
Chromaluxe Aluminium Gloss Clear - 508 x 508 mm (10 pcs)	508	508	4275	88275355	-	385,57
Chromaluxe Aluminium Gloss Clear - 508 x 610 mm (9 pcs)	508	609,6	4276	88275356	-	396,13
Chromaluxe Aluminium Gloss Clear - 508 x 762 mm (6 pcs)	508	762	4251	88275359	-	509,26
Chromaluxe Aluminium Gloss Clear - 600 x 800 mm (10 pcs)	600	800	3111	88275360	-	525,36
Chromaluxe Aluminium Gloss Clear - 610 x 610 mm (10 pcs)	609,6	609,6	4277	88275364	-	428,47
Chromaluxe Aluminium Gloss Clear - 610 x 762 mm (10 pcs)	609,6	762	4278	88275411	-	525,36
Chromaluxe Aluminium Gloss Clear - 610 x 914 mm (10 pcs)	609,6	914,4	4279	88275412	-	773,52
Chromaluxe Aluminium Gloss Clear - 762 x 762 mm (10 pcs)	762	762	4281	88275413	-	965,58
Chromaluxe Aluminium Gloss Clear - 762 x 1016 mm (10 pcs)	762	1016	4282	88275415	-	983,00
Chromaluxe Aluminium Gloss Clear - 965 x 1473 mm (3 pcs)	965,2	1473,2	4266	88275416	-	758,92
<b>Aluminium Photo Panel: Semi Gloss Clear - 1 Side / Naturel Semi Brillant - 1 Face / 1,14 mm.</b>						
Chromaluxe Aluminium Semi-Gloss Clear - 1200 x 2400 mm (Full sheet)	1200	2400	9449	88275417	-	278,37
Chromaluxe Aluminium Semi-Gloss Clear - 1200 x 1200 mm (Half sheet)	1200	1200	9585	88275418	-	146,14
Chromaluxe Aluminium Semi-Gloss Clear - 1200 x 600 mm (Quarter sheet)	1200	600	9586	88275419	-	76,72
Chromaluxe Aluminium Semi-Gloss Clear - 102 x 102 mm (10 pcs)	101,6	101,6	4579	88275421	-	25,15
Chromaluxe Aluminium Semi-Gloss Clear - 127 x 178 mm (10 pcs)	127	177,8	4580	88275422	-	52,54
Chromaluxe Aluminium Semi-Gloss Clear - 150 x 150 mm (10 pcs)	150	150	3136	88275423	-	41,39
Chromaluxe Aluminium Semi-Gloss Clear - 150 x 200 mm (10 pcs)	150	200	3137	88275424	-	56,10
Chromaluxe Aluminium Semi-Gloss Clear - 200 x 300 mm (10 pcs)	200	300	3138	88275425	-	94,51
Chromaluxe Aluminium Semi-Gloss Clear - 203 x 254 mm (10 pcs)	203,2	254	4581	88275426	-	80,26
Chromaluxe Aluminium Semi-Gloss Clear - 203 x 305 mm (10 pcs)	203,2	304,8	4582	88275427	-	92,80
Chromaluxe Aluminium Semi-Gloss Clear - 279 x 356 mm (10 pcs)	279,4	355,6	4583	88275428	-	133,72
Chromaluxe Aluminium Semi-Gloss Clear - 300 x 300 mm (10 pcs)	300	300	3139	88275429	-	115,63
Chromaluxe Aluminium Semi-Gloss Clear - 300 x 400 mm (10 pcs)	300	400	3140	88275430	-	149,42
Chromaluxe Aluminium Semi-Gloss Clear - 305 x 457 mm (10 pcs)	304,8	457,2	4584	88275431	-	193,38
Chromaluxe Aluminium Semi-Gloss Clear - 400 x 600 mm (10 pcs)	400	600	3141	88275432	-	290,14
Chromaluxe Aluminium Semi-Gloss Clear - 406 x 508 mm (10 pcs)	406,4	508	4585	88275433	-	276,28
Chromaluxe Aluminium Semi-Gloss Clear - 406 x 610 mm (10 pcs)	406,4	609,6	4586	88275435	-	375,01
Chromaluxe Aluminium Semi-Gloss Clear - 500 x 500 mm (10 pcs)	500	500	3071	88275439	-	385,57
Chromaluxe Aluminium Semi-Gloss Clear - 508 x 762 mm (10 pcs)	508	762	4587	88275440	-	509,26
Chromaluxe Aluminium Semi-Gloss Clear - 600 x 800 mm (10 pcs)	600	800	3143	88275441	-	525,36
Chromaluxe Aluminium Semi-Gloss Clear - 700 x 1000 mm (10 pcs)	700	1000	3144	88275442	-	983,80
Chromaluxe Aluminium Semi-Gloss Clear - 762 x 1016 mm (10 pcs)	762	1016	4588	88275443	-	983,00
Chromaluxe Aluminium Semi-Gloss Clear - 1016 x 1524 mm (3 pcs)	1016	1524	4589	88275444	-	665,50



## CHROMALUXE ALUMINIUM - Aluminium CHROMALUXE

Description			Supplier Ref.	Papyrus Ref.	Info	€/Pack
<b>Aluminium Photo Panel: Matte Clear - 1 Side / Naturel Mat - 1 Face / 1,14 mm.</b>						
Chromaluxe Aluminium Matte Clear - 1200 x 2400 mm (Full sheet)	1200	2400	9448	88275445	-	278,37
Chromaluxe Aluminium Matte Clear - 1200 x 1200 mm (Half sheet)	1200	1200	9450	88275446	-	146,14
Chromaluxe Aluminium Matte Clear - 1200 x 600 mm (Quarter sheet)	1200	600	6892	88275447	-	76,72
Chromaluxe Aluminium Matte Clear - 102 x 102 mm (10 pcs)	101,6	101,6	4305	88275449	-	25,15
Chromaluxe Aluminium Matte Clear - 127 x 178 mm (10 pcs)	127	177,8	4057	88275450	-	52,54
Chromaluxe Aluminium Matte Clear - 150 x 150 mm (10 pcs)	150	150	3103	88275451	-	41,39
Chromaluxe Aluminium Matte Clear - 150 x 200 mm (10 pcs)	150	200	3104	88275452	-	56,10
Chromaluxe Aluminium Matte Clear - 200 x 300 mm (10 pcs)	200	300	3105	88275453	-	94,51
Chromaluxe Aluminium Matte Clear - 203 x 254 mm (10 pcs)	203,2	254	4012	88275455	-	80,26
Chromaluxe Aluminium Matte Clear - 279 x 356 mm (10 pcs)	279,4	355,6	4013	88275456	-	133,72
Chromaluxe Aluminium Matte Clear - 298 x 298 mm (10 pcs)	298,4	298,4	4061	88275457	-	115,63
Chromaluxe Aluminium Matte Clear - 300 x 300 mm (10 pcs)	300	300	3101	88275458	-	115,63
Chromaluxe Aluminium Matte Clear - 300 x 400 mm (10 pcs)	300	400	3106	88275459	-	149,42
Chromaluxe Aluminium Matte Clear - 305 x 610 mm (10 pcs)	304,8	609,6	4285	88275460	-	177,54
Chromaluxe Aluminium Matte Clear - 400 x 600 mm (10 pcs)	400	600	3109	88275466	-	290,14
Chromaluxe Aluminium Matte Clear - 406 x 508 mm (10 pcs)	406,4	508	4019	88275467	-	276,28
Chromaluxe Aluminium Matte Clear - 600 x 800 mm (10 pcs)	600	800	3112	88275468	-	525,36

### Aluminium Photo Creative Border Panel: Gloss White - 1 Side / Blanc Brillant - 1 Face / mm.

Creative Border metal prints are a great addition to any space and will transform photos into their own piece of art. Use images alone or create a digital border to match any home décor.

Les tirages Creative Border en métal sont une excellente valeur ajoutée à tout environnement et transformeront les photos en réelles œuvres d'art. Utilisez des images seules ou créez une bordure numérique correspondant à n'importe quel décor.



GW - Benelux Creative Border Metal - 1 Side - (small) - 203 x 289 mm	203	289	4087	88284159	-	10	114,14
GW - Berlin Creative Border Metal - 1 Side - (small) - 201 x 303 mm	201	201	4149	88284160	-	10	110,29
GW - Circle Creative Border Metal - 1 Side - Ø 203 mm	203	203	4144		-	10	77,87
GW - Circle Creative Border Metal - 1 Side - Ø 279 mm	279	279	4145	88284258	-	10	119,11
GW - Milan Creative Border Metal - 1 Side - (small) - 203 x 203 mm	203	203	4089	88284167	-	10	95,01

## CHROMALUXE ALUMINIUM - Aluminium CHROMALUXE

### Aluminium Photo Creative Border Panel: Gloss White - 1 Side / Blanc Brillant - 1 Face / 1,14 mm.

GW - Prague Creative Border Metal - 1 Side - (small) 201 x 201 mm (10 pcs)	201	201	4158	88284253	-		90,54
GW - Sydney Creative Border Metal - 1 Side - (small) - 203 x 254 mm (10 pcs)	203	254	4094	88284255	-		98,86

## CHROMALUXE ALUMINIUM Extended - Aluminium CHRO-

ChromaLuxe EXT gives users the ability to take prints outdoors, or into direct sunlight with the image quality and durability they've come to expect from other ChromaLuxe products. These UV resistant panels come in a variety of common sizes to serve the signage, display and outdoor photography markets.

ChromaLuxe EXTended donne aux utilisateurs la possibilité d'afficher les impressions à l'extérieur ou en plein soleil avec la qualité d'image et la durabilité attendus avec les autres produits - ChromaLuxe. Ces panneaux résistants aux UV sont disponibles dans une variété de tailles courantes pour servir les marchés de la signalétique, l'affichage extérieur et la photographie.



Description	mm.	mm.	Supplier Ref.	Papyrus Ref.	Info	€/Pack
-------------	-----	-----	---------------	--------------	------	--------

### Aluminium Extended Panels: Metal Panel Gloss White - 1 Side / Panneau Métallique Blanc Brillant - 1 Face / 1,14 mm.

Texte NL  
Texte FR

Chromaluxe EXT Aluminium Gloss White - 1200 x 2400 mm (Full sheet)	1200	2400	4749	88275487	-	320,13
Chromaluxe EXT Aluminium Gloss White - 127 x 178 mm (10 pcs)	127	178	4750	88275489	-	60,41
Chromaluxe EXT Aluminium Gloss White - 203 x 254 mm (10 pcs)	203,2	254	4752	88275491	-	92,29
Chromaluxe EXT Aluminium Gloss White - 279 x 356 mm (10 pcs)	279,4	355,6	4753	88275493	-	153,77
Chromaluxe EXT Aluminium Gloss White - 305 x 457 mm (10 pcs)	304,8	457,2	4754	88275494	-	222,39
Chromaluxe EXT Aluminium Gloss White - 508 x 762 mm (10 pcs)	508	762	4756	88275495	-	585,64
Chromaluxe EXT Aluminium Gloss White - 610 x 762 mm (10 pcs)	609,6	762	4757	88275496	-	604,16
Chromaluxe EXT Aluminium Gloss White - 610 x 914 mm (10 pcs)	609,6	914,4	4758	88275497	-	889,55
Chromaluxe EXT Aluminium Gloss White - 762 x 1016 mm (10 pcs)	762	1016	4759	88275498	-	1130,46
Chromaluxe EXT Aluminium Gloss White - 1016 x 1524 mm (3 pcs)	1016	1524	4760	88275499	-	979,00

## CHROMALUXE Wood Panel MDF Panneau de bois MDF CHROMALUXE

Hout / vezelplaat biedt de perfecte combinatie van duurzaamheid en duurzaamheid voor het maken en weergeven van prachtige, levendige bewegwijzering of kunstwerken met een traditionele uitstraling.

Le panneau de fibres de bois de densité moyenne (MDF) offre la longévité parfaite pour créer et afficher de magnifiques visuels dynamiques avec un ressenti traditionnel.

Regular MDF: Gloss White - 1 Side - Black Back / Blanc brillant simple Face - Dos Noir / 16 mm.

With a black chamfered edge and gloss white surface, ChromaLuxe Wood Prints provide a wonderful alternative to metal prints while providing the same high quality image reproduction. The thickness of the material makes it a great look for any home, office or commercial space.

Avec un bord chanfreiné noir et une surface blanche brillante, les impressions bois ChromaLuxe offrent une excellente alternative aux impressions métalliques tout en offrant la même qualité d'image. L'épaisseur du matériau en fait un excellent choix pour toute maison, bureau ou espace commercial.

Chromaluxe MDF Wood Photo Panel Gloss White - 1200 x 2400 mm	1200	2400	5888	88275508	-	222,14
Chromaluxe MDF Wood Photo Panel Gloss White - 1200 x 1200 mm	1200	1200	8512	88275509	-	116,62
Chromaluxe MDF Wood Photo Panel Gloss White - 1200 x 600 mm	1200	600	9180	88275510	-	61,23
Chromaluxe MDF Wood Photo Panel Gloss White - 100 x 150 mm (10 pcs)	100	150	3032	88275511	-	56,14
Chromaluxe MDF Wood Photo Panel Gloss White - 150 x 150 mm (10 pcs)	150	150	3033	88275512	-	64,46
Chromaluxe MDF Wood Photo Panel Gloss White - 180 x 270 mm (10 pcs)	180	270	3034	88275514	-	61,60
Chromaluxe MDF Wood Photo Panel Gloss White - 200 x 300 mm (8 pcs)	200	300	3059	88275517	-	76,90
Chromaluxe MDF Wood Photo Panel Gloss White - 203 x 254 mm (14 pcs)	203	254	4286	88275518	-	117,72
Chromaluxe MDF Wood Photo Panel Gloss White - 229 x 457 mm (10 pcs)	229	457	4050	88275520	-	188,41
Chromaluxe MDF Wood Photo Panel Gloss White - 240 x 360 mm (10 pcs)	240	360	3035	88275522	-	103,71
Chromaluxe MDF Wood Photo Panel Gloss White - 279 x 356 mm (9 pcs)	279	356	5877	88275526	-	121,05
Chromaluxe MDF Wood Photo Panel Gloss White - 291 x 291 mm (10 pcs)	291	291	3036	88275527	-	89,18
Chromaluxe MDF Wood Photo Panel Gloss White - 295 x 295 mm (9 pcs)	295	295	5946	88275528	-	110,22
Chromaluxe MDF Wood Photo Panel Gloss White - 300 x 400 mm (10 pcs)	300	400	3037	88275530	-	138,86
Chromaluxe MDF Wood Photo Panel Gloss White - 400 x 600 mm (6 pcs)	400	600	3039	88275534	-	136,07
Chromaluxe MDF Wood Photo Panel Gloss White - 406 x 508 mm (5 pcs)	406	508	4126	88275535	-	111,03
Chromaluxe MDF Wood Photo Panel Gloss White - 500 x 500 mm (6 pcs)	500	500	3038	88275537	-	178,10
Chromaluxe MDF Wood Photo Panel Gloss White - 508 x 762 mm (4 pcs)	508	762	4127	88275538	-	160,17
Chromaluxe MDF Wood Photo Panel Gloss White - 600 x 800 mm (4 pcs)	600	800	3041	88275539	-	170,26
Chromaluxe MDF Wood Photo Panel Gloss White - 700 x 700 mm (4 pcs)	700	700	3040	88275541	-	196,43
Chromaluxe MDF Wood Photo Panel Gloss White - 700 x 1000 mm (2 pcs)	700	1000	3042	88275542	-	129,77

## CHROMALUXE MAPLE VENEER/MDF Mdf Placage érable CHROMALUXE

ChromaLuxe MDF-esdoornfineerpanelen bieden de combinatie van levendige beeldkwaliteit en duurzaamheid met de natuurlijke uitstraling van esdoornhout. Perfect voor het weergeven van illustraties en fotografie in verschillende commerciële toepassingen. Les panneaux de placage d'érable MDF ChromaLuxe offrent la combinaison d'une qualité d'image vibrante et d'une durabilité avec l'aspect naturel du bois d'érable. Parfait pour afficher des illustrations et des photographies dans une variété d'applications commerciales.

Description		Supplier Ref.	Papyrus Ref.	Info	€/Pack
-------------	---	---------------	--------------	------	--------

Natural Wood Panel: Maple Matte Clear VNR - 1 side / Erable Mat Clair - 1 Face / 16 mm.

ChromaLuxe maple panels are durable, made with recycled material and 100% recyclable. Because images are infused directly into specially coated sheets of veneer and MDF, ChromaLuxe offers unsurpassed color vibrancy, exceptional detail, color resolution and print permanence. Les panneaux d'érable ChromaLuxe sont durables, faits de matériaux recyclés et recyclables à 100%. Parce que les images sont directement infusées dans des feuilles de placage de MDF spécialement revêtues, ChromaLuxe offre un éclat de couleurs inégalé, des détails exceptionnels, une résolution des couleurs et une permanence d'impression.

Chromaluxe MDF Natural Wood Photo Panel - 1200 x 2400 mm (Full Sheet)	1200	2400	4527	88275543	-	334,67
Chromaluxe MDF Natural Wood Photo Panel - 1200 x 1200 mm (Half Sheet)	1200	1200	8939	88275544	-	169,76
Chromaluxe MDF Natural Wood Photo Panel - 1200 x 600 mm (Quarter Sheet)	1200	600	8940	88275545	-	92,24
Chromaluxe MDF Natural Wood Photo Panel - 203 x 203 mm (14 pcs)	203	203	4528	88275546	-	131,24
Chromaluxe MDF Natural Wood Photo Panel - 203 x 254 mm (14 pcs)	203	254	4529	88275549	-	152,53
Chromaluxe MDF Natural Wood Photo Panel - 254 x 254 mm (14 pcs)	254	254	4530	88275550	-	176,34
Chromaluxe MDF Natural Wood Photo Panel - 279 x 356 mm (9 pcs)	279	356	4531	88275551	-	168,74
Chromaluxe MDF Natural Wood Photo Panel - 406 x 508 mm (9 pcs)	406	508	4532	88275553	-	178,62
Chromaluxe MDF Natural Wood Photo Panel - 508 x 762 mm (4 pcs)	508	762	4533	88275554	-	246,79
Chromaluxe MDF Natural Wood Photo Panel - 762 x 1016 mm (2 pcs)	762	1016	4534	88275555	-	258,44

## CHROMALUXE Moisture Resistant MDF Panneau de bois MDF CHROMALUXE résistant à l'Humidité

The thick, dense and moisture resistant MR-MDF is the core substrate for our durable table tops. A specialty coated product created to reduce stains and scratches, the MR-MDF table tops still brings the highest image quality. A mid-gloss level lets colors shine while reducing the appearances of scratches and smudges. Sold in two popular shapes and sizes with a black PVC banding make this product a complete solution for tables in a variety of settings.

Le Mr-MDF épais, dense et résistant à l'humidité est le substrat de base pour les plateaux de table durables. Un produit spécifique enduit pour réduire les taches et les rayures, les dessus de table MR-MDF apporte toujours la meilleure qualité d'image. Un niveau de brillance moyenne permet aux couleurs de briller tout en réduisant l'apparence des rayures et des taches. Vendu en deux formes et tailles populaires avec un ruban PVC noir, ce produit est une solution complète pour les tables dans une variété de paramètres.

Moisture Resistant MDF - Table Top: Semi Gloss White - 1 Side - Clear Back / Blanc Semi brillant simple Face - Dos naturel / mm.

ChromaLuxe Table Tops are specially coated moisture resistant MDF (MRMDF) that resists, scratches and stains and can be wiped clean with any non-abrasive cleaner. ChromaLuxe Table Tops allow you to customize furniture with the highest quality HD image available.

Les dessus de table ChromaLuxe sont des MDF spécialement enduits résistants à l'humidité (MRMDF) qui résistent aux rayures et aux taches et peuvent être nettoyés avec n'importe quel nettoyant non abrasif. Les dessus de table ChromaLuxe vous permettent de personnaliser les meubles avec l'image Haute définition de la plus haute qualité disponible.



4398 - 4400



4397 - 4399

Chromaluxe MDF Round Table Top - 600 mm (6 pcs)	600	600	4398	88275556	-	436,22
Chromaluxe MDF Round Table Top - 746 mm (6 pcs)	746	746	4400	88275557	-	688,62
Chromaluxe MDF Square Table Top - 603 x 603 mm (6 pcs)	603	603	4397	88275558	-	304,50
Chromaluxe Square Table Top - 749 x 749 mm (6 pcs)	749	749	4399	88275560	-	579,50



## CHROMALUXE HARDBOARD - Panneaux HDF Chromaluxe

Hardboardpanelen zijn verkrijgbaar in 3 mm en 6 mm dik karton en bieden een superieure weergave van het beeld en kras-, slijt- en vlekbestendigheid. Er is ook een speciale droogwaste coating beschikbaar.

Les panneaux haute densité sont disponibles en panneaux de 3 mm et 6 mm d'épaisseur et offrent une reproduction d'image supérieure ainsi qu'une résistance aux rayures, à l'abrasion et aux taches. Un revêtement effaçable à sec spécialement formulé est également disponible.

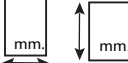
Description		Supplier Ref.	Papyrus Ref.	Info	Pack. unit	€/Pack
-------------	---	---------------	--------------	------	------------	--------

Hardboard Photo Panels with easel - Flat Top: Gloss White - 1 Side - Black Back / Blanc brillant simple Face - Dos Noir / mm.

Easeld photo panels have a black radius edge and black back with matching pre-attached easel for easy table top display  
Les panneaux photo avec chevalet ont un bord arrondi noir et un dos noir avec un chevalet pré-assemblé assorti pour une dépose facile.



5857



3084



3058



5859



3027



5931



5932

GW - HB - Rectangle photo panel + easel - Flat Top - 127 x 178 mm	127	178	5857	88284315	-	12	61,85
GW - HB - Rectangle photo panel + easel - Flat Top 130 x 180 mm	130	180	3084	88284320	-	12	72,58
GW - HB - Rectangle photo panel + easel - Flat Top 200 x 300 mm	200	300	3058	88284324	-	12	115,51
GW - HB - Rectangle photo panel + easel - Flat Top 203,2 x 254 mm	203,2	254	5859	88284322	-	12	90,91
GW - HB - Square photo panel + easel - Flat Top 150 x 150 mm	150	150	3027	88284321	-	16	81,49
GW - HB - Square photo panel + easel - Flat Top 152,4 x 152,4 mm	152,4	152,4	5931	88284323	-	10	50,92
GW - HB - Square photo panel + easel - Flat Top 254 x 254 mm	254	254	5932	88284325	-	12	106,56

Photo Panels with easel - Arch Top: Gloss White - 1 Side - Black Back / Blanc brillant simple Face - Dos Noir / 6,35 mm.

Easeld photo panels have a black radius edge and black back with matching pre-attached easel for easy table top display  
Les panneaux photo avec chevalet ont un bord arrondi noir et un dos noir avec un chevalet pré-assemblé assorti pour une dépose facile.

GW - HB - Rectangle photo panel with easel - 130 x 180 mm	130	180	3085	88284327	-	12	72,58
GW - HB - Rectangle photo panel with easel - 203,2 x 254 mm	203,2	254	5860	88284328	-	12	90,91

## CHROMALUXE HARDBOARD - Panneaux HDF Chromaluxe

Description			Supplier Ref.	Papyrus Ref.	Info	Pack. unit	€/Pack
-------------	---	---	---------------	--------------	------	------------	--------

### Photo Panels with KickStand - Flat Top: Gloss White - 1 Side - Black Back / Blanc brillant simple Face - Dos Noir / 6,35 mm.

Slots are located on all four sides on the back of each panel for either landscape or portrait display. Panels have a black back and edge and come with a black kickstand.

Des fentes sont situées sur les quatre côtés à l'arrière de chaque panneau pour l'affichage en mode paysage ou portrait. Les panneaux ont un dos et un bord noirs et sont livrés avec une béquille noire.

GW - HB - Square panel + KickStand - Flat Top 150 x 150 mm	150	150	3123	88284331	-	20	101,84
GW - HB - Square panel + KickStand - Flat Top 152,4 x 152,4 mm	152,4	152,4	4612	88284332	-	20	101,84
GW - HB - Square panel + KickStand - Flat Top 254 x 254 mm	254	254	4613	88284338	-	15	133,20
GW - HB - Rectangle panel + KickStand - Flat Top - 127 x 178 mm	127	178	4610	88284333	-	20	103,09
GW - HB - Rectangle panel + KickStand - Flat Top 130 x 180 mm	130	180	3124	88284334	-	20	120,89
GW - HB - Rectangle panel + KickStand - Flat Top 200 x 300 mm	200	300	3125	88284336	-	15	144,38
GW - HB - Rectangle panel + KickStand - Flat Top 203,2 x 254 mm	203,2	254	4609	88284337	-	15	113,64

### Hinged Desktop Photo Panels - Vertical Flat Top: Gloss White - 1 Side - Black Back / Blanc brillant simple Face - Dos Noir / 6,35 mm.

GW - HB - Flat - Duo Hinged panel (left and right) - 127 x 178 mm (x2)	178	254	5873	88284330	-	10	75,64
GW - HB - Flat - Tri Hinged panel - 127 x 178 mm (x1)+ 88,9 x 127 mm (x2)	127	355,8	4002	88284329	-	10	91,66

### Hinged Desktop panels - Vertical Arch Top: Gloss White - 1 Side - Black Back / Blanc brillant simple Face - Dos Noir / 6,35 mm.

GW - HB - Arch - Duo Hinged panel (left and right) - 100 x 130 mm (x2)	130	200	3086	-	-	8	39,87
GW - HB - Arch - Duo Hinged panel (Center) - 100 x 130 mm (x1)	100	130	3087	-	-	16	60,01
GW - HB - Arch - Duo Hinged panel (left and right) - 130 x 180 mm (x2)	360	180	3088	-	-	10	72,40
GW - HB - Arch - Duo Hinged panel (Center) - 130 x 180 mm (x1)	130	180	3089	-	-	20	95,14

## CHROMALUXE Steel - Acier CHROMALUXE

Specially coated with superior dry erase properties, steel panels not only provide vibrant imagery, but are easy to write on and wipe off.

Spécialement revêtus avec des propriétés d'effacement à sec supérieures, les panneaux d'acier fournissent non seulement des images vibrantes, mais sont faciles à écrire et à effacer.

Steel Panel: Steel Gloss White - 1 Side / Acier Blanc Brillant - 1 Face / 0,58 mm.

Steel panels are extremely durable and offer the ability to customize dry erase boards with logos, artwork or photography. Because images are infused directly into specially coated sheets of steel, our material offers unsurpassed color vibrancy, exceptional detail, color resolution and print permanence.

Les panneaux d'acier sont extrêmement durables et offrent la possibilité de personnaliser les tableaux effaçables à sec avec des logos, des illustrations ou des photographies. Parce que les images sont infusées directement dans des feuilles d'acier spécialement revêtues, notre matériau offre une brillance des couleurs inégalée, des détails exceptionnels, une résolution des couleurs et une permanence d'impression.

GW Steel Dry Erase - 1 side - 203 x 254 mm	203	254	5957	88286679	-	10	75,39
GW Steel Dry Erase - 1 side - 229 x 305 mm	229	305	5958	88286680	-	10	86,94
GW Steel Dry Erase - 1 side - 279 x 356 mm	279	356	5955	88286678	-	10	112,66
GW Steel Dry Erase - 1 side - 302 x 606 mm	302	606	5960	88286681	-	10	157,86

## UNISUB ALUMINIUM - Aluminium UNISUB

Aluminum panels are lightweight, durable, made with recycled material and 100% recyclable. They are the perfect medium for displaying artwork and photography in a variety of applications from residential to commercial usage.

Les panneaux d'aluminium sont légers, durables, faits de matériaux recyclés et recyclables à 100%. Ils sont le moyen idéal pour afficher des œuvres d'art et de la photographie dans une variété d'applications d'usage résidentiel à commercial.



Description	mm.	mm.	Supplier Ref.	Papyrus Ref.	Info	Pack. unit	€/Pack
<b>Aluminium Photo Panel: Gloss White - 1 Side / Blanc Brillant - 1 Face / 0,75 mm.</b>							
US - GW - Alu. Photo Panel - 1 Side - 1200 x 2400 mm	1200	2400	5613	88286628	-	1	217,45
US - GW - Alu. Photo Panel - 1 Side - 1200 x 1200 mm	1200	1200	7489	88286702	-	1	114,16
US - GW - Alu. Photo Panel - 1 Side - 1200 x 600 mm	1200	600	6255	88286691	-	1	59,93
US - GW - Alu. Photo Panel - 1 Side - 305 x 610 mm	305	610	5570	88286619	-	10	134,77
US - GW - Alu. Photo Panel - 1 Side - 591 x 1194 mm	591	1194	5629	88286632	-	10	583,97
<b>Aluminium Photo Panel: Gloss White - 2 Sides / Blanc Brillant - 2 Faces / 1,14 mm.</b>							
US - GW - Alu. Photo Panel - 2 Sides - 1200 x 600 mm	1200	600	8923	88286714	-	1	91,44
<b>Aluminium Photo Panel: Gloss Clear - 1 Side / Naturel Brillant - 1 Face / 0,75 mm.</b>							
US - GCI - Alu. Photo Panel - 1 Side - 1200 x 2400 mm	1200	2400	8772	88286712	-	1	217,45
<b>Aluminium Photo Panel: Matte White - 1 Side / Blanc Mat - 1 Face / 0,75 mm.</b>							
US - MW - Alu. Photo Panel - 1 Side - 1200 x 2400 mm	1200	2400	6162	88286690	-	1	217,45
US - MW - Alu. Photo Panel - 1 Side - 1200 x 1200 mm	1200	1200	9488	88286719	-	1	114,16
<b>Aluminium Photo Panel: Semi Gloss White - 1 Side / Blanc Semi Brillant - 1 Face / 0,75 mm.</b>							
US - SMGW - Alu. Photo Panel - 1 Side - 1200 x 2400 mm	1200	2400	8793	88286713	-	1	217,45

## UNISUB ALUMINIUM - Aluminium UNISUB



Description



Supplier  
Ref.

Papyrus  
Ref.

Info

Pack.  
unit

€/Pack

### Aluminium Clocks: White - 1 Side / brillant - simple Face / mm.

Kit includes a sublimatable face, hands and motor  
Les kits comprennent les faces sublimables, le support et le moteur.



Product Description	Supplier Ref.	Papyrus Ref.	Info	Pack. unit	€/Pack
US - GW - HB - 1 Side Round Wall Clock Kit - No Frame- Ø 260 mm.	260	260	5627	88286631	- 14 204,66
US - GW - HB - 1 Side Round Wall Clock Kit - With Black Frame- Ø 260 mm.	260	260	5650	-	8 251,51
US - GCL - HB - 1 Side Round Wall Clock Kit - No Frame- Ø 260 mm.	260	260	5947	88286677	- 14 201,34

### Aluminium Business cards: Gloss White - 2 Sides / Blanc Brillant - 2 Faces / mm.



Product Description	Supplier Ref.	Papyrus Ref.	Info	Pack. unit	€/Pack
US - GW - Alu. - Name Insert For Business Card Holder 5751 - 51 x 89 mm	51	89	5733	88286659	- 50 55,26
US - GW - wood - Business card holder w/ alu. insert (5733) - 2x 51 x 89 mm	76	102	5751	88286661	- 10 68,56

### Aluminium Name Badges: Gloss Clear - 1 Side / Naturel Brillant - 1 Face / mm.



US - GCI - Alu. - 1 Side Name Badge w/Round Corners - 51 x 76 mm	51	76	5950	-	150 176,99
--	----	----	------	---	------------

## UNISUB ALUMINIUM - Aluminium UNISUB

Description	mm.	mm.	Supplier Ref.	Papyrus Ref.	Info	Pack. unit	€/Pack
-------------	-----	-----	---------------	--------------	------	------------	--------

Aluminium Name Badges: Gloss White - 1 Side / Blanc Brillant - 1 Face / mm.



US - GW - Alu. - 1 Side Name Badge w/Round Corners - 32 x 76 mm	32	76	4460	-	100	64,58
US - GW - Alu. - 1 Side Name Badge w/Round Corners - 38 x 76 mm	38	76	4461	-	100	83,21
US - GW - Alu. - 1 Side Name Badge w/Round Corners - 51 x 76 mm	51	76	4467	-	100	111,78
US - GW - Alu. - 1 Side Name Badge w/Round Corners - 54 x 86 mm	54	86	4462	-	100	111,78
US - GW - Alu. - 1 Side Name Badge w/Square Corners - 51 x 89 mm	51	89	5748	-	50	73,49
US - GW - Alu. - 1 Side Name Badge w/Square Corners - 64 x 89 mm	64	89	5731	-	50	100,40
US - GW - Alu. - 1 Side Name Badge Ovale - 25 x 76 mm	25	76	4463	-	100	83,21

Aluminium Name Badges: Matt White - 1 Side / Blanc Mat - 1 Face / mm.



US - MW - Alu. - 1 Side Name Badge w/Round Corners - 38 x 76 mm	38	76	4466	-	100	83,21
US - MW - Alu. - 1 Side Name Badge w/Round Corners - 51 x 76 mm	51	76	4470	-	100	111,78



## UNISUB ALUMINIUM - Aluminium UNISUB

Description	mm.	mm.	Supplier Ref.	Papyrus Ref.	Info	Pack. unit	€/Pack
-------------	-----	-----	---------------	--------------	------	------------	--------

### Aluminium Magnets: Semi Gloss White - 1 Side / Blanc Semi Brillant - 1 Face / mm.

Pair with a magnetic dry erase board or decorate a refrigerator door. These metal shapes include a self adhesive magnet to attach after sublimating.

Associez à un tableau magnétique effaçable à sec ou pour décorer une porte du réfrigérateur, ces formes métalliques comprennent un aimant auto-collant à attacher après sublimation.



US - SMGW - Alu. - 1 Side	Wine Glass shape Magnet - 41 x 69 mm	41	69	4669	-	50	39,00
US - SMGW - Alu. - 1 Side	Awareness Ribbon shape Magnet - 41 x 70 mm	41	70	4659	-	50	39,00
US - SMGW - Alu. - 1 Side	Car shape Magnet - 41 x 70 mm	52	70	4535	-	50	39,00
US - SMGW - Alu. - 1 Side	Two Part Heart shape Magnet - 69 x 81 mm	69	81	4663	-	50	79,80

### Aluminium Magnets: Gloss White - 1 Side / Blanc Brillant - 1 Face / mm.

Pair with a magnetic dry erase board or decorate a refrigerator door. These metal shapes include a self adhesive magnet to attach after sublimating.

Associez à un tableau magnétique effaçable à sec ou pour décorer une porte du réfrigérateur, ces formes métalliques comprennent un aimant auto-collant à attacher après sublimation.



US - GW - Alu. - 1 Side	Small Round shape Magnet - Ø 25 mm	25	25	4417	-	50	36,64
US - GW - Alu. - 1 Side	Large Round shape Magnet - Ø 51 mm	51	51	4410	-	50	56,51
US - GW - Alu. - 1 Side	Rectangle shape Magnet - 51 x 76 mm	51	76	5734	-	50	77,00
US - GW - Alu. - 1 Side	T-Shirt shape Magnet - 64 x 70 mm	64	70	4409	-	50	80,11

## UNISUB HARDBOARD - Panneaux HDF UNISUB

Hardboardpanelen zijn verkrijgbaar in 3 mm en 6 mm dik karton en bieden een superieure weergave van het beeld en kras-, slijt- en vlekbestendigheid. Er is ook een speciale droogwaste coating beschikbaar.

Les panneaux haute densité sont disponibles en panneaux de 3 mm et 6 mm d'épaisseur et offrent une reproduction d'image supérieure ainsi qu'une résistance aux rayures, à l'abrasion et aux taches. Un revêtement effaçable à sec spécialement formulé est également disponible.

Description	mm.	mm.	Supplier Ref.	Papyrus Ref.	Info	Pack. unit	€/Pack
-------------	-----	-----	---------------	--------------	------	------------	--------

### Hardboard Panels: Gloss White - 1 Side - Black Back / Blanc brillant - simple Face / 3,18 mm.

US - GW - HB - 1 Side Black Back - 1200 x 2400 mm	1200	2400	5610	88286627	-	1	123,40
US - GW - HB - 1 Side Black Back - 1200 x 1200 mm	1200	1200	7508	88286703	-	1	64,79
US - GW - HB - 1 Side Black Back - 1200 x 600 mm	1200	600	7386	88286698	-	1	34,01

### Hardboard Panels: Gloss White - 2 Sides - Black Back / Blanc brillant - Double Face / 3,18 mm.

US - GW - HB - 2 Sides Black Back - 1200 x 2400 mm	1200	2400	9096	88286715	-	1	193,72
US - GW - HB - 2 Sides Black Back - 1200 x 1200 mm	1200	1200	9097	88286716	-	1	101,70
US - GW - HB - 2 Sides Black Back - 1200 x 600 mm	1200	600	8572	88286711	-	1	53,40

### Hardboard Panels: Matt White - 1 Side - Black Back / Blanc Mat - simple Face / 3,18 mm.

US - MW - HB - 1 Side Black Back - 1200 x 2400 mm	1200	2400	7170	88286695	-	1	123,08
US - MW - HB - 1 Side Black Back - 1200 x 1200 mm	1200	1200	7488	88286701	-	1	64,62

### Hardboard Panels: Gloss White - 1 Side - Black Back / Blanc brillant - simple Face / 6 mm.

US - GW - HB - 1 Side Black Back - 1200 x 2400 mm	1200	2400	7154	88286693	-	1	135,12
US - GW - HB - 1 Side Black Back - 1200 x 1200 mm	1200	1200	7513	88286704	-	1	70,94
US - GW - HB - 1 Side Black Back - 1200 x 600 mm	1200	600	7387	88286699	-	1	37,24

### Clocks: Gloss White - 1 Side - Black Edges / Blanc brillant - simple Face - Bords Noirs / mm.

Kit includes a sublimatable face, hands and motor  
Les kits comprennent les faces sublimables, le support et le moteur.



US - GW - HB - 1 Side Large Round Wall Clock Kit - Ø 290 mm.	290	290	5823	88286671	-	10	227,17
US - GW - HB - 1 Side Mahogany Vertical Mantle Clock Kit w/Square Tile (102 x 102 mm) And Vertical Tile (152 x 200 mm)	290	290					290
5756	88286662	-	2	90,69			
US - GW - HB - 1 Side Desktop Clock w/Stand - 102 x 102 mm	102	102	1027	88286545	-	10	166,64
US - GW - HB - 1 Side Round Clock Face Only - w/10mm Hole - Ø 206 mm	206	206	3000		-	20	94,64
US - GW - HB - 1 Side Heart Clock Face Only - 290 mm	290	290	3005		-	25	168,91
US - GW - HB - 1 Side Round Clock Face Only - Ø 290 mm	290	290	3007		-	25	232,88
US - GW - HB - 1 Side Insert For 5756 Vertical Mantle Clock 152 x 152 mm.	152	152	5683	88286648	-	26	74,27
US - GW - HB - 1 Side Insert For 5756 Vertical Mantle Clock 152 x 200 mm.	152	200	5684	88286649	-	26	103,01

## UNISUB HARDBOARD - Panneaux HDF UNISUB

Description			Supplier Ref.	Papyrus Ref.	Info	Pack. unit	€/Pack
-------------	---	---	---------------	--------------	------	------------	--------

### Coasters with cork back: Gloss White - 1 Side - Black Back / Blanc brillant - simple Face / mm.

These coasters are a great way to add personalized home decor. Available in various shapes with a cork backing.  
Ces sous-verres sont un excellent moyen d'ajouter un décor personnalisé. Disponible dans diverses formes avec un dos de liège.

					5677	5795	4015	5822	5701							
US - GW - HB - 1 Side Coaster - Square w/Cork Back - 95 x 95 mm	US - GW - HB - 1 Side Coaster - Square Puzzle w/Cork Back - 194 x 194 mm	US - GW - HB - 1 Side Coaster - Heart w/Cork Back - 102 x 98 mm	US - GW - HB - 1 Side Coaster - Round w/Cork Back - Ø 95 mm Round	US - Wood 4 Slotted Mahogany Coaster Holder - 64 x 76 mm	95	194	98	95	64	95	95	5677	88286645	-	40	57,14
												5795	88286668	-	10	71,17
												4015	88286550	-	40	64,10
												5822	88286670	-	40	64,10
												5701	-	10	25,09	

### Coasters with raw back: Gloss White - 1 Side - Black Back / Blanc brillant - simple Face / mm.

These coasters are a great way to add personalized home decor. Available in various shapes with raw backing.  
Ces sous-verres sont un excellent moyen d'ajouter un décor personnalisé. Disponible dans diverses formes avec un dos brut.

				4430	1009	4026	4028									
US - GW - HB - 1 Side Coaster - Pumpkin w/raw Back - 95 x 88 mm	US - GW - HB - 1 Side Coaster - Square w/raw Back - 102 x 102 mm	US - GW - HB - 1 Side Coaster - Square w/raw Back - 90 x 90 mm	US - GW - HB - 1 Side Coaster - Round w/raw Back - Ø 90 mm	95	102	90	90	88	102	90	90	4430	-	40	-	
												1009	88286538	-	40	42,72
												4026	88286551	-	40	32,78
												4028	88286552	-	40	32,78

### Clipboards: Gloss White - 2 Sides / Blanc brillant double Faces / mm.

These customizable two-sided clipboards include a flat or standard clip that is attached after sublimation using rivets. 25 rivets are included with each case.  
Ces presse-papiers à deux faces personnalisables comprennent un clip plat ou standard qui est fixé après sublimation à l'aide de rivets. 25 rivets sont inclus avec chaque coli.

				5994	1013	1014	5634									
US - GW - HB - Mini Clipboard w/Flat Clip - 152 x 229 mm	US - GW - HB - Clipboard w/Flat Clip - 229 x 318 mm	US - GW - HB - Clipboard w/Standard Clip - 229 x 318 mm	US - GW - HB - Clipboard w/Flatclip 9"x15.5" / 229 x 394 mm	152	229	229	229	229	229	229	229	5994	88286689	-	12	78,54
												1013	88286542	-	12	107,45
												1014	88286543	-	12	109,40
												5634	88286633	-	12	121,47



## UNISUB HARDBOARD - Panneaux HDF UNISUB

Description			Supplier Ref.	Papyrus Ref.	Info	Pack. unit	€/Pack
-------------	---	---	---------------	--------------	------	------------	--------

### Serving Trays - Natural wood: Gloss White - 1 Side / Blanc brillant - simple Face / mm.

Personalize any serving tray with a logo, family name, monogram or favorite kitchen décor. Available as small or large trays in natural wood finish, the hardboard sublimatable bottom is attached to the rails after sublimation.

Personnalisez n'importe quel plateau avec un logo, un nom de famille, un monogramme ou un décor de cuisine préféré. Disponible en petits ou grands plateaux en finition bois naturel, le fond sublimable est fixé sur les rails après sublimation.



5710



5673 - 5700



5672 - 5699



5709

US - GW - HB - 1 Side Small Natural Serving Tray w/HB Insert #5710	254	356	5673	88286644	-	2	43,10
US - GW - HB - 1 Side Small Natural Serving Tray w/HB Insert #5710	254	356	5700	88286652	-	25	434,08
US - GW - HB - 1 Side Small Serving Tray Inserts - 207 x 331 mm	207	331	5710	88286656	-	8	34,29
US - GW - HB - 1 Side Large Natural Serving Tray w/HB Insert #5709	330	460	5672	88286643	-	2	67,07
US - GW - HB - 1 Side Large Natural Serving Tray w/HB Insert #5709	330	460	5699	88286651	-	25	649,89
US - GW - HB - 1 Side Large Serving Tray Inserts - 287 x 435 mm	287	435	5709	88286655	-	10	66,45

### Serving Trays - ESPRESSO BLACK: Gloss White - 1 Side / Blanc brillant - simple Face / mm.

Personalize any serving tray with a logo, family name, monogram or favorite kitchen décor. Available as small or large trays in Black wood finish, the hardboard sublimatable bottom is attached to the rails after sublimation.

Personnalisez n'importe quel plateau avec un logo, un nom de famille, un monogramme ou un décor de cuisine préféré. Disponible en petits ou grands plateaux en finition bois noir, le fond sublimable est fixé sur les rails après sublimation.



5710



5988 - 5987



5986 - 5985



5709

US - GW - HB - 1 Side Small espresso Black Serving Tray with Insert #5710	254	356	5988	88286686	-	2	43,10
US - GW - HB - 1 Side Small espresso Black Serving Tray with Insert #5710	254	356	5987	88286685	-	25	434,08
US - GW - HB - 1 Side Small Serving Tray Inserts - 207 x 331 mm	207	331	5710	88286656	-	8	34,29
US - GW - HB - 1 Side Large espresso Black Serving Tray with Insert #5709	330	460	5986	88286684	-	2	67,07
US - GW - HB - 1 Side Large espresso Black Serving Tray with Insert #5709	330	460	5985	88286683	-	25	649,89
US - GW - HB - 1 Side Large Serving Tray Inserts - 287 x 435 mm	287	435	5709	88286655	-	10	66,45

## UNISUB HARDBOARD - Panneaux HDF UNISUB

Description			Supplier Ref.	Papyrus Ref.	Info	Pack. unit	€/Pack
-------------	---	---	---------------	--------------	------	------------	--------

### Puzzles: Gloss White - 1 Side / Blanc brillant - simple Face / mm.

These hardboard jigsaw puzzles come ready to sublimate without film. Small parts, not recommended for children ages 3 and under. Ces puzzles en bois dur sont prêts à sublimer sans film. Petites pièces, non recommandé pour les enfants de 3 ans et moins.



4742

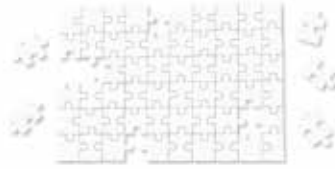

4743



4744



4745

US - GW - HB - 1 Side Jigsaw Puzzle - 30 pcs. Rectangle - 175 x 250 mm	175	250	4742	88286589	-	10	65,23
US - GW - HB - 1 Side Jigsaw Puzzle - 60 pcs. Rectangle - 175 x 250 mm	175	250	4743	88286590	-	10	72,53
US - GW - HB - 1 Side Jigsaw Puzzle - 25 pcs. Square - 170 x 170 mm	170	179	4744	88286592	-	10	56,29
US - GW - HB - 1 Side Jigsaw Puzzle - 23 pcs. Heart - 166 x 170 mm	166	170	4745	88286593	-	10	53,31
US - GW - HB - 1 Side Jigsaw Puzzle - 96 pcs. Rectangle - 173 x 248 mm	173	248	3145	88286546	-	10	81,20
US - GW - HB - 1 Side Jigsaw Puzzle - 96 pcs. Rectangle - 248 x 356 mm	248	356	3146	88286547	-	10	130,72
US - GW - HB - 1 Side Jigsaw Puzzle - 150 pcs. Rectangle - 250 x 360 mm	250	360	9493	88286720	-	10	158,32

### Picture Frame: Gloss White - 1 Side - Black edges / Blanc brillant - simple Face - Bords Noirs / mm.

This hardboard picture frame includes an easel and mylar lens. Ce cadre d'image HDF comprend un chevalet et une protection en mylar.



5899

US - GW - HB - 1 Side Picture Frame w/Easel and mylar lens - 178 x 216 mm	175	250	5899	88286675	-	10	106,82
---	-----	-----	------	----------	---	----	--------

### Message Board: Gloss White - 1 Side - Black Edges / Blanc brillant - simple Face - Bords Noirs / mm.

Customers will love these personalized one-sided dry erase boards. Items have radius corners. Hang tabs are included. Les clients adoreront ces tableaux effaçables à sec personnalisés. Ces articles ont des coins arrondis. Les languettes de suspension sont incluses.



1010



1011



1012

US - GW - HB - 1 Side Dry Erase Board - 191 x 229 mm	190,5	228,6	1010	88286539	-	20	75,27
US - GW - HB - 1 Side Dry Erase Board - 203 x 262 mm	203,2	261,6	1011	88286540	-	20	90,91
US - GW - HB - 1 Side Dry Erase Board - 229 x 318mm	228,6	317,5	1012	88286541	-	20	109,30

## UNISUB Wood Panel MDF - Panneau de bois MDF UNISUB

Hout / vezelplaat biedt de perfecte combinatie van duurzaamheid en duurzaamheid voor het maken en weergeven van prachtige, levendige bewegwijzering of kunstwerken met een traditionele uitstraling.

Le panneau de fibres de bois de densité moyenne (MDF) offre la longévité parfaite pour créer et afficher de magnifiques visuels dynamiques avec un ressenti traditionnel.

Description	mm.	mm.	Supplier Ref.	Papyrus Ref.	Info	Pack. unit	€/Pack
-------------	-----	-----	---------------	--------------	------	------------	--------

### Regular MDF 19 mm. Plate: Gloss White - 1 Side - Black Back / Blanc brillant simple Face - Dos Noir / 19 mm.

With a black chamfered edge and gloss white surface, ChromaLuxe Wood Prints provide a wonderful alternative to metal prints while providing the same high quality image reproduction. The thickness of the material makes it a great look for any home, office or commercial space.

Avec un bord chanfreiné noir et une surface blanche brillante, les impressions bois ChromaLuxe offrent une excellente alternative aux impressions métalliques tout en offrant la même qualité d'image. L'épaisseur du matériau en fait un excellent choix pour toute maison, bureau ou espace commercial.

US - GW - MDF - 1 Side Black Back - 1200 x 2400 mm	1200	2400	7155	88286694	-	1	226,03
US - GW - MDF - 1 Side Black Back - 1200 x 1200 mm	1200	1200	8538	88286710	-	1	118,66

### Cherry Ogee Edge Plaques: Gloss White - 1 Side - w/Cherry Edge / Blanc brillant simple Face - Avec Bord Merisier / mm.

Recognition deserves attention – create lasting memories of achievements with full color plaques available in a variety of sizes and shapes.

La reconnaissance mérite l'attention - créez des souvenirs durables de réalisations avec des plaques de couleur disponibles dans une variété de tailles et de formes.



5670



1005



1006

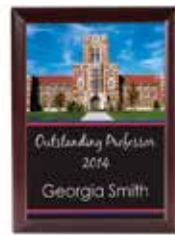

1007



1008

US - GW - MDF - Plaque w/Cherry Ogee Edge - 127 x 178 mm	127	178	5670	88286642	-	28	141,46
US - GW - MDF - Plaque w/Cherry Ogee Edge - 152 x 203 mm	152	203	1005	88286534	-	21	107,45
US - GW - MDF - Plaque w/Cherry Ogee Edge - 178 x 229 mm	178	229	1006	88286535	-	20	124,20
US - GW - MDF - Plaque w/Cherry Ogee Edge - 203 x 254 mm	203	254	1007	88286536	-	14	97,02
US - GW - MDF - Plaque w/Cherry Ogee Edge - 229 x 305 mm	229	305	1008	88286537	-	12	109,99

### Black Ogee Edge Plaques: Gloss White - 1 Side - w/Black Edge / Blanc brillant simple Face - Avec Bord Noir / mm.



5669



1001



1002



1003



1004

US - GW - MDF - Plaque w/Black Ogee Edge - 127 x 178 mm	127	178	5669	88286641	-	28	108,16
US - GW - MDF - Plaque w/Black Ogee Edge - 152 x 203 mm	152	203	1001	88286525	-	21	107,45
US - GW - MDF - Plaque w/Black Ogee Edge - 178 x 229 mm	178	229	1002	88286531	-	20	124,20
US - GW - MDF - Plaque w/Black Ogee Edge - 203 x 254 mm	203	254	1003	88286532	-	14	97,02
US - GW - MDF - Plaque w/Black Ogee Edge - 229 x 305 mm	229	305	1004	88286533	-	12	109,99

## UNISUB Wood Panel MDF - Panneau de bois MDF UNISUB

Description	mm.	mm.	Supplier Ref.	Papyrus Ref.	Info	Pack. unit	€/Pack
-------------	-----	-----	---------------	--------------	------	------------	--------

Flat Edge / Extra Large / Clock Plaque : Gloss White - 1 Side - w/Black Edge / Blanc brillant simple Face - Avec Bord Noir / mm.



5664



5758



5584

US - GW - MDF - Plaque w/Black Flat Edge - 203 x 254 mm	203	254	5664	88286638	-	14	97,02
US - GW - MDF - Desktop Clock w/Black Flat Edge - 140 x 203 mm - 19 mm	140	203	5758	88286664	-	8	97,57
US - GW - MDF - Extra Large w/Black Ogee Edge - 295 x 406 mm - 19 mm	295	406	5584	88286620	-	7	121,73

Specialty Shaped Plaques: Gloss White - 1 Side - w/Black Edge / Blanc brillant simple Face - Avec Bord Noir / mm.



Shield



Football



Home Plate



Round

US - GW - MDF - Small Shield Plaque w/Black Edge - 127 x 152 mm	127	152	5745	88286660	-	15	144,38
US - GW - MDF - Large Shield Plaque w/Black Edge - 191 x 232 mm	191	232	5616	88286629	-	6	86,74
US - GW - MDF - Football Plaque w/Black Edge - 267 x 159 mm	159	267	5757	88286663	-	12	157,38
US - GW - MDF - Small Homeplate Plaque - 152 x 152 mm	152	152	5679	88286646	-	15	93,90
US - GW - MDF - Large Homeplate Plaque - 254 x 254 mm	254	254	5680	88286647	-	12	149,65
US - GW - MDF - Round Plaque w/Black Edge - Ø 206 mm	206	206	5765	88286665	-	12	157,38

## UNISUB Steel Panel - Panneaux Acier UNISUB

Specially coated with superior dry erase properties, steel panels not only provide vibrant imagery, but are easy to write on and wipe off.

Spécialement revêtus avec des propriétés d'effacement à sec supérieures, les panneaux d'acier fournissent non seulement des images vibrantes, mais sont faciles à écrire et à effacer.

Steel Panel: Steel Gloss White - 1 Side / Acier Blanc Brillant - 1 Face / 0,58 mm.



Steel panels are extremely durable and offer the ability to customize dry erase boards with logos, artwork or photography. Because images are infused directly into specially coated sheets of steel, our material offers unsurpassed color vibrancy, exceptional detail, color resolution and print permanence.

Les panneaux d'acier sont extrêmement durables et offrent la possibilité de personnaliser les tableaux effaçables à sec avec des logos, des illustrations ou des photographies. Parce que les images sont infusées directement dans des feuilles d'acier spécialement revêtues, notre matériau offre une brillance des couleurs inégalée, des détails exceptionnels, une résolution des couleurs et une permanence d'impression.

US - GW Steel Dry Erase - 1 side - 1200 x 2400 mm	1200	2400	6888	88286692	-	1	194,52
US - GW Steel Dry Erase - 1 side - 1200 x 1200 mm	1200	1200	8515	88286709	-	1	102,12
US - GW Steel Dry Erase - 1 side - 1200 x 600 mm	1200	600	7433	88286700	-	1	53,61

## PVC

### PVC - PVC

	forma(a)t cm	ref. Papyrus	info	oppervlak surface		1  €/1000 vel/feuilles
---	-----------------	-----------------	------	----------------------	--	--

#### Transparent - Transparent

150 µ.	21 x 29,7	88105681	-	gloss/gloss	300	94,19
250 µ.	21 x 29,7	88105684	-	gloss/gloss	200	147,77
150 µ.	70 x 100	88105682	-	gloss/gloss	100/3600	737,30
200 µ.	70 x 100	88105683	-	gloss/gloss	50/2500	975,88
500 µ.	70 x 100	88105686	-	gloss/gloss	50/1000	2451,52

#### Transparent Anti-Reflect - Transparent Anti-Reflet

##### Aangepast voor offset UV - Adapté pour Offset UV

250 µ.	70 x 100	88105687	-	matt/gloss	50/2000	1155,37
500 µ.	70 x 100	88105689	-	matt/gloss	25/1000	2291,51

#### White Gloss - Blanc Brillant

##### Verbeterde opaciteit - Opacité améliorée

400 µ.	70 x 100	88105695	-	gloss/high gloss	50/1400	2137,14
500 µ.	70 x 100	88105696	-	gloss/high gloss	50/1000	2671,44
750 µ.	70 x 100	88105697	-	gloss/gloss	25/700	3746,48
1000 µ.	70 x 100	88105698	-	gloss/gloss	20/500	5231,45

#### White Matt - Blanc Mat

300 µ.	70 x 100	88105690	-	fine matt/matt	50/2000	1571,43
--------	----------	----------	---	----------------	---------	---------

## PET GAG & POLYSTYRENE

### PET GAG - PET GAG

#### Transparent - Transparent

200 µ.	70 x 100	88105700	-	gloss/gloss	50	893,74
500 µ.	70 x 100	88105703	-	gloss/gloss	50	2234,36

### POLYSTYRENE - POLYSTYRENE

#### White Matt/Matt - Blanc Mat/Mat



1000 µ.	70 x 100	88105742	-	matt/matt	30/690	3438,44
2000 µ.	70 x 100	88105743	-	matt/matt	15/345	6876,84

Andere specificaties: min. 500 kg

Autres spécifications sur demande min. 500 kg

## BI-PROPB

### POLYPROP CORRUGATED - POLYPROPYLENE ALVEOLAIRE

	forma(a)t cm	ref. Papyrus	info	oppervlak surface		1  €/1000 vel/feuilles
<b>BIPROPB White - BIPROPB Blanc</b>						
4,0 mm.	100 x 70 //	88105750	-	650g/m <sup>2</sup>	265	1972,45
4,0 mm.	70 x 100 //	88105751	-	650g/m <sup>2</sup>	265	1972,45
4,0 mm.	100 x 140 //	88105746	-	700g/m <sup>2</sup>	265	4360,33
4,0 mm.	140 x 100 //	88105748	-	700g/m <sup>2</sup>	265	4360,33
<b>BI-SQUARE White - BI-SQUARE Blanc</b>						
3,5 mm.	80 x 120 //	88105755	-	650g/m <sup>2</sup>	300	3241,07
4,0 mm.	70 x 100 //	88105754	-	700g/m <sup>2</sup>	265	2564,70
<b>BI-SQUARE Yellow - BI-SQUARE Jaune</b>						
3,5 mm.	80 x 120 //	88105758	-	650g/m <sup>2</sup>	300	3412,73

2-zijdig coronabehandeld, bedrukbaarheid beperkt in de tijd

Bij het versnijden is er een lichte samendruk van de kanaaltjes mogelijk naast de snijlijn

Traité corona 2 faces, imprimabilité limitée dans le temps.

Une faible déformation des cannelures est possible près de la ligne de découpe



# Papyrus Viscom

Prijslijst / Liste de prix  
Tools

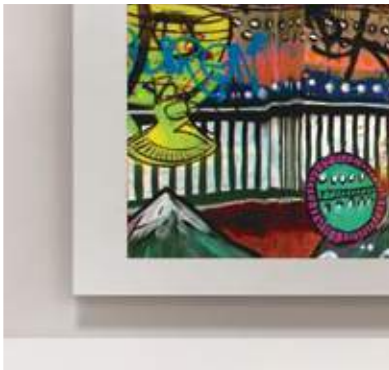









**PAPYRUS**   
Your partner in Visual Communication

# Tools

APPLICATION TOOLS . . . . .	185
ACCESSOIRES DE POSE ET DE DEPOSE . . . . .	185
CUTTING TOOLS . . . . .	190
ACCESSOIRES POUR LA DECOUPE . . . . .	190
VARIOUS ACCESSORIES . . . . .	196
ACCESSOIRES DIVERS . . . . .	196
ACCESSOIRES FOR SOLAR FILMS . . . . .	199
ACCESSOIRES POUR FILMS SOLAIRES . . . . .	199
WRAP TOOLS and ACCESSORIES . . . . .	202
ACCESSOIRES POUR TOTAL COVERING . . . . .	202
BANNER TOOLS and ACCESSORIES . . . . .	206
ACCESSOIRES POUR BACHES . . . . .	206
LIQUIDS . . . . .	208
LIQUIDES . . . . .	208
WIPING . . . . .	211
PAPIER - PAPIER . . . . .	211
NON WOVENS - Non-Tissés. . . . .	212
NON WOVENS - Non-Tissés. . . . .	213
DISPENSERS PAPER AND NON WOVENS . . . . .	214
DOUBLE SIDED TAPES . . . . .	214
PROTECTION PACKAGING SHIPPING . . . . .	215
PROTECTION EMBALLAGE EXPEDITION . . . . .	215
LUCHTKUSSENFOLIE - FILM A BULLES . . . . .	215
KLEEFBANDEN - RUBANS ADHESIFS. . . . .	215
VERZENDKOKERS - MANDRINS D'EXPEDITION . . . . .	216







# APPLICATION TOOLS ACCESSOIRES DE POSE ET DE DEPOSE

	OMSCHRIJVING			DESCRIPTION		
	Avery Squeegee Pro Flexible (Rood - flexible)			Raclette Pro Flexible (Rouge - souple) Avery		
	Article n°:	Box Label:	Info:	Dimensions	Qtty/Pack:	Unit Price:
	540063	CA9080002	min 12	10 x 7,2 cm	12	4,18
	OMSCHRIJVING			DESCRIPTION		
	Avery Squeegee Pro (Blauw - medium flex)			Raclette Pro (Bleu - moyenne souple) Avery		
	Article n°:	Box Label:	Info:	Dimensions	Qtty/Pack:	Unit Price:
	540007	CA3480002	min 12	10 x 7,2 cm	12	4,78
	OMSCHRIJVING			DESCRIPTION		
	Avery Squeegee Pro Rigid (White - rigid)			Raclette Pro Rigid (Blanc - rigide) Avery		
	Article n°:	Box Label:	Info:	Dimensions	Qtty/Pack:	Unit Price:
	88170447	AP8270002	min 12	10 x 7,2 cm	12	4,90
	OMSCHRIJVING			DESCRIPTION		
	Avery Squeegee Pro XL (Zwart - medium+ flex)			Raclette Pro XL (Noir - moyenne+ souple) Avery		
	Article n°:	Box Label:	Info:	Dimensions	Qtty/Pack:	Unit Price:
	540230	CA8120002	min 6	13 x 7,8 cm	6	5,79
	OMSCHRIJVING			DESCRIPTION		
	Avery Squeegee FleXtreme			Raclette FleXtreme Avery		
	Article n°:	Box Label:	Info:	Dimensions	Qtty/Pack:	Unit Price:
	2028756	CB2620001	-	-	2	17,37
	OMSCHRIJVING			DESCRIPTION		
	Squeegee voor vensters			Raclette pour vitre		
	Article n°:	Box Label:	Info:	Dimensions	Qtty/Pack:	Unit Price:
	247033	MARVITRE	-	-	1	1,13
	OMSCHRIJVING			DESCRIPTION		
	Soft squeegee			Raclette Souple		
	Article n°:	Box Label:	Info:	Dimensions	Qtty/Pack:	Unit Price:
	247029	MARBLEU	-	-	1	3,49
	OMSCHRIJVING			DESCRIPTION		
	MARBLEU Squeegee met rode vilt			Raclette MARBLEU avec feutre rouge		
	Article n°:	Box Label:	Info:	Dimensions	Qtty/Pack:	Unit Price:
	247075	MARBLEUF	-	-	1	3,18
	OMSCHRIJVING			DESCRIPTION		
	Medium Squeegee			Raclette Médium		
	Article n°:	Box Label:	Info:	Dimensions	Qtty/Pack:	Unit Price:
	247032	MAROR	-	-	1	3,94

# APPLICATION TOOLS ACCESSOIRES DE POSE ET DE DEPOSE

OMSCHRIJVING		DESCRIPTION					
	Harde Squeegee		Raclette Dure				
	Article n°:	Box Label:	Info:	Dimensions	Qty/Pack:	Unit Price:	
	247031	MARNOIR	-	-	1	3,55	
	Viltten Squeegee		Raclette feutre				
	Article n°:	Box Label:	Info:	Dimensions	Qty/Pack:	Unit Price:	
	247019	FEUTRE	-	-	1	6,04	
	LIBERTE - BLAUWE SQUEEGEE: extreem flexibele zuigmond, speciaal aangepast voor toepassingen op gebogen oppervlakken. Voorkomt de vorming van luchtbellen tijdens de installatie.		LIBERTE - RACLETTE BLEUE : raclette extrêmement souple, spécialement adaptée aux applications sur surfaces courbes. Évite la formation de bulles d'air pendant la pose.				
	Article n°:	Box Label:	Info:	Dimensions	Qty/Pack:	Unit Price:	
	88293287	Liberte	New, 🕒		1	3,78	
	EGALITE - WITTE SQUEEGEE: stijve zuigmond, speciaal aangepast voor toepassingen op grote vlakke oppervlakken.		EGALITE - RACLETTE BLANCHE : raclette rigide, spécialement adaptée aux applications sur surfaces planes de grandes tailles.				
	Article n°:	Box Label:	Info:	Dimensions	Qty/Pack:	Unit Price:	
	88293277	EGALITE	New, 🕒		1	3,78	
	FRATERNITE - RODE SQUEEGEE: wisser van gemiddelde flexibiliteit, speciaal aangepast voor toepassingen op vlakke of licht gebogen oppervlakken.		FRATERNITE - RACLETTE ROUGE : raclette de flexibilité moyenne, spécialement adaptée aux applications sur surfaces planes ou légèrement incurvées.				
	Article n°:	Box Label:	Info:	Dimensions	Qty/Pack:	Unit Price:	
	88293281	Fraternite	New, 🕒		1	3,78	
	FRENCHBOX - Doos met 3 squeegees + 3 squeegee beschermingen		FRENCHBOX - Boîte de 3 raclettes + 3 protections de raclette.				
	Article n°:	Box Label:	Info:	Dimensions	Qty/Pack:	Unit Price:	
	88293282	Frenchbox	New, 🕒		1	32,9	
	Plastic Squeegee rood – soepel		Raclette plastique souple (rouge)				
	Article n°:	Box Label:	Info:	Dimensions	Qty/Pack:	Unit Price:	
	247044	PLASSOUPLE	-	-	1	0,86	
	Plastic Squeegee blauw – middel		Raclette plastique medium (bleu)				
	Article n°:	Box Label:	Info:	Dimensions	Qty/Pack:	Unit Price:	
	247043	PLASMOYEN	-	-	1	0,95	
	MACSQUEEG - Magnetische squeegee		MACSQUEEG - Raclette magnétique.				
	Article n°:	Box Label:	Info:	Dimensions	Qty/Pack:	Unit Price:	
	88293288	Magsqueeg	New, 🕒		1	5,7	

# APPLICATION TOOLS ACCESSOIRES DE POSE ET DE DEPOSE

	OMSCHRIJVING			DESCRIPTION		
	YelloMini "Hang-Loose" 45 ° - Wanneer u uw voertuigen afdekt, kunt u met deze schuine rakel moeilijke gebieden bereiken, zoals contouren van koplampen, afdichtingen van beglazingen, enz.			YelloMini "Hang-Loose" 45 ° - Lors de vos recouvrement de véhicules, cette racle coudée vous permettra d'atteindre les zones difficiles comme les contours de phares, les joints de vitrage...		
	Article n°:	Box Label:	Info:	Dimensions	Qtty/Pack:	Unit Price:
	88309878	YT12HL045	New	45°	10	3,49
	YelloMini "Hang-Loose" 90 ° - Wanneer u uw voertuigen afdekt, kunt u met deze schuine squeegee moeilijke gebieden bereiken, zoals contouren van koplampen, afdichtingen van beglazingen, enz.			YelloMini "Hang-Loose" 90 ° - Lors de vos recouvrement de véhicules, cette racle coudée vous permettra d'atteindre les zones difficiles comme les contours de phares, les joints de vitrage...		
	Article n°:	Box Label:	Info:	Dimensions	Qtty/Pack:	Unit Price:
	88309879	YT12HL090	New	90°	10	3,49
	Stoomreiniger			Nettoyeur vapeur haute pression		
	Article n°:	Box Label:	Info:	Dimensions	Qtty/Pack:	Unit Price:
	88169881	STEAMERSC1	-		1	206,8
	Pakket van 5 rode zelfklevende vilt om te snijden en op squeegees te kleven			Paquet de 5 feuilles feutrine rouge autoadhésive pour regarnir les raclettes		
	Article n°:	Box Label:	Info:	Dimensions	Qtty/Pack:	Unit Price:
	247020	FEUTROUGE2	-	A5	10-pack	22,92
	HexFelt - Microfiber Felt			HexFelt - Feutrine Microfibre		
	Article n°:	Box Label:	Info:	Dimensions	Qtty/Pack:	Unit Price:
	88299338	Hexfelt	New	25mm. X 5 m.	1	15
	SHAGFELT - Voorgesneden vilt (pak van 5).			SHAGFELT - Feutrine prédécoupée (paquet de 5).		
	Article n°:	Box Label:	Info:	Dimensions	Qtty/Pack:	Unit Price:
	88293298	Shagfelt	New		1	5,1
	SHAGDRILL- Bubble pen, verwijdert luchtballen na het aanbrengen van de film.			SHAGDRILL- Stylo perce-bulles, permet d'éliminer les bulles d'air après application du film.		
	Article n°:	Box Label:	Info:	Dimensions	Qtty/Pack:	Unit Price:
	88293297	Shagdrill	New		1	5,36
	Hand Roller			Rouleau applicateur		
	Article n°:	Box Label:	Info:	Dimensions	Qtty/Pack:	Unit Price:
	88103763	APPLIC15	-	15 cm	1	47,13
	Vinylzapper			Ponceuse electronique équipée d'une roulette en gomme (non incluse)		
	Article n°:	Box Label:	Info:	Dimensions	Qtty/Pack:	Unit Price:
	88103799	VINYLZAPPER	🕒	-	1	456,65

## APPLICATION TOOLS ACCESSOIRES DE POSE ET DE DEPOSE

	OMSCHRIJVING			DESCRIPTION		
	Wiel voor Vinylzapper			Roulette pour le Vinyl Zapper		
	Article n°:	Box Label:	Info:	Dimensions	Qtty/Pack:	Unit Price:
	88103800	VINY LZAPPER WHEEL	-	-	1	37,81
	OMSCHRIJVING			DESCRIPTION		
	Vloeibaar dichtingslaminaat - 250ml			Vernis de Scellement - 250ml		
	Article n°:	Box Label:	Info:	Dimensions	Qtty/Pack:	Unit Price:
	88103682	VR7077	-	-	1	11,93
	OMSCHRIJVING			DESCRIPTION		
	Pen om randen af te dicht			Stylo pour sceller les bords des graphiques		
	Article n°:	Box Label:	Info:	Dimensions	Qtty/Pack:	Unit Price:
	88103683	SEALIT	-	-	1	16,99
	OMSCHRIJVING			DESCRIPTION		
	Squeeband - Magnetische strip voor raclette			Squeeband - Bande Magnétique pour raclette		
	Article n°:	Box Label:	Info:	Dimensions	Qtty/Pack:	Unit Price:
	88293305	Squeeband	New, 🕒		1	18,13
	OMSCHRIJVING			DESCRIPTION		
	YelloRoller Flexi 50 hard - Zeer ergonomische en verstelbare handgrieppositie. De rollen gemonteerd op hoogwaardige kogellagers ontlasten uw spieren door eenvoudig aan de hendel te draaien. Robuuste constructie - Vijf verschillende maten - 3 jaar garantie			YelloRoller Flexi 50 hard - Position de la poignée hautement ergonomique et réglable. Les rouleaux montés sur roulement à billes hautes performances épargnent vos tendons et vos muscles en tournant simplement la poignée. Fabrication robuste - Cinq tailles différentes - Garantie de 3 ans		
	Article n°:	Box Label:	Info:	Dimensions	Qtty/Pack:	Unit Price:
	88309881	YT12YRF05H	New	50 mm. Hard roll	1	49,9
	OMSCHRIJVING			DESCRIPTION		
	YelloRoller Flexi 100 hard - Zeer ergonomische en verstelbare handgrieppositie. De rollen gemonteerd op hoogwaardige kogellagers ontlasten uw spieren door eenvoudig aan de hendel te draaien. Robuuste constructie - Vijf verschillende maten - 3 jaar garantie			YelloRoller Flexi 100 hard - Position de la poignée hautement ergonomique et réglable. Les rouleaux montés sur roulement à billes hautes performances épargnent vos tendons et vos muscles en tournant simplement la poignée. Fabrication robuste - Cinq tailles différentes - Garantie de 3 ans		
	Article n°:	Box Label:	Info:	Dimensions	Qtty/Pack:	Unit Price:
	88309882	YT12YRF10H	New	100 mm. Hard roll	1	59,9
	OMSCHRIJVING			DESCRIPTION		
	YelloRoller Flexi 100 soft - Zeer ergonomische en verstelbare handgrieppositie. De rollen gemonteerd op hoogwaardige kogellagers ontlasten uw spieren door eenvoudig aan de hendel te draaien. Robuuste constructie - Vijf verschillende maten - 3 jaar garantie			YelloRoller Flexi 100 soft - Position de la poignée hautement ergonomique et réglable. Les rouleaux montés sur roulement à billes hautes performances épargnent vos tendons et vos muscles en tournant simplement la poignée. Fabrication robuste - Cinq tailles différentes - Garantie de 3 ans		
	Article n°:	Box Label:	Info:	Dimensions	Qtty/Pack:	Unit Price:
	88309883	YT12YRF10S	New	100 mm. Soft roll	1	59,9
	OMSCHRIJVING			DESCRIPTION		
	WallRoller Handy Mono Hard. Eendelige applicatierol. Perfect voor vloer- en wandtoepassingen of voor klinknagels.			WallRoller Handy Mono Hard. Rouleau d'application monobloc. Parfait pour les applications au sol et au mur ou pour les rivets.		
	Article n°:	Box Label:	Info:	Dimensions	Qtty/Pack:	Unit Price:
	88309866	YT14WRHM03H	New	44 x 75 x 13 mm	1	69,8









# APPLICATION TOOLS ACCESSOIRES DE POSE ET DE DEPOSE

	OMSCHRIJVING	DESCRIPTION												
	WallRoller Handy Mono Soft. Eendelige applicatierol. Perfect voor vloer- en wandtoepassingen of voor klinknagels.	"WallRoller Handy Mono Soft. Rouleau d'application monobloc. Parfait pour les applications au sol et au mur ou pour les rivets.												
	<table border="1"> <tr> <th>Article n°:</th> <th>Box Label:</th> <th>Info:</th> </tr> <tr> <td>88309867</td> <td>YT14WRHM01S</td> <td>New</td> </tr> </table>	Article n°:	Box Label:	Info:	88309867	YT14WRHM01S	New	<table border="1"> <tr> <th>Dimensions</th> <th>Qtty/Pack:</th> <th>Unit Price:</th> </tr> <tr> <td>44 x 75 x 13 mm</td> <td>1</td> <td>79,8</td> </tr> </table>	Dimensions	Qtty/Pack:	Unit Price:	44 x 75 x 13 mm	1	79,8
Article n°:	Box Label:	Info:												
88309867	YT14WRHM01S	New												
Dimensions	Qtty/Pack:	Unit Price:												
44 x 75 x 13 mm	1	79,8												
	WallRoller Basic - Perfecte vinyl applicatie-tool - zelfs voor grote afbeeldingen. De WallRoller biedt maximale kracht voor uw armen elke keer dat u hem op de muur of vloer aanbrengt.	WallRoller Basic - Outil d'application de vinyle parfait - même pour les grands graphiques. Le WallRoller fournit une force maximale pour vos bras à chaque application au mur ou au sol.												
	<table border="1"> <tr> <th>Article n°:</th> <th>Box Label:</th> <th>Info:</th> </tr> <tr> <td>88309868</td> <td>YT11WR002</td> <td>New</td> </tr> </table>	Article n°:	Box Label:	Info:	88309868	YT11WR002	New	<table border="1"> <tr> <th>Dimensions</th> <th>Qtty/Pack:</th> <th>Unit Price:</th> </tr> <tr> <td>175 x 86 x 44 mm</td> <td>1</td> <td>249</td> </tr> </table>	Dimensions	Qtty/Pack:	Unit Price:	175 x 86 x 44 mm	1	249
Article n°:	Box Label:	Info:												
88309868	YT11WR002	New												
Dimensions	Qtty/Pack:	Unit Price:												
175 x 86 x 44 mm	1	249												
	YelloRoller Flexi 150 hard - Zeer ergonomische en verstelbare handgrieppositie. De rollen gemonteerd op hoogwaardige kogellagers ontlasten uw spieren door eenvoudig aan de hendel te draaien. Robuuste constructie - Vijf verschillende maten - 3 jaar garantie	YelloRoller Flexi 150 hard - Position de la poignée hautement ergonomique et réglable. Les rouleaux montés sur roulement à billes hautes performances épargnent vos tendons et vos muscles en tournant simplement la poignée. Fabrication robuste - Cinq tailles différentes - Garantie de 3 ans												
	<table border="1"> <tr> <th>Article n°:</th> <th>Box Label:</th> <th>Info:</th> </tr> <tr> <td>88309884</td> <td>YT12YRF15H</td> <td>New</td> </tr> </table>	Article n°:	Box Label:	Info:	88309884	YT12YRF15H	New	<table border="1"> <tr> <th>Dimensions</th> <th>Qtty/Pack:</th> <th>Unit Price:</th> </tr> <tr> <td>150 mm. Hard roll</td> <td>1</td> <td>69,9</td> </tr> </table>	Dimensions	Qtty/Pack:	Unit Price:	150 mm. Hard roll	1	69,9
Article n°:	Box Label:	Info:												
88309884	YT12YRF15H	New												
Dimensions	Qtty/Pack:	Unit Price:												
150 mm. Hard roll	1	69,9												
	StreetRoller "Basic" - Met deze ergonomische StreetRoller kunt u allerlei Floor-Graphics snel en eenvoudig toepassen.	StreetRoller "Basic" - Ce StreetRoller ergonomique permet d'appliquer toutes sortes de Floor-Graphics rapidement et facilement.												
	<table border="1"> <tr> <th>Article n°:</th> <th>Box Label:</th> <th>Info:</th> </tr> <tr> <td>88309858</td> <td>YT11SR002</td> <td>New</td> </tr> </table>	Article n°:	Box Label:	Info:	88309858	YT11SR002	New	<table border="1"> <tr> <th>Dimensions</th> <th>Qtty/Pack:</th> <th>Unit Price:</th> </tr> <tr> <td>175 x 86 x 44 mm</td> <td>1</td> <td>299</td> </tr> </table>	Dimensions	Qtty/Pack:	Unit Price:	175 x 86 x 44 mm	1	299
Article n°:	Box Label:	Info:												
88309858	YT11SR002	New												
Dimensions	Qtty/Pack:	Unit Price:												
175 x 86 x 44 mm	1	299												
	GeckoPatches M - U wilt niet-magnetische oppervlakken zoals glasvezela, aluminium of kunststof deuren "magnetisch" maken - druk gewoon op onze GeckoPatch en blijf uw magneten gebruiken zoals gewoonlijk.	GeckoPatches M. Vous voulez rendre "magnétiques" des surfaces non magnétiques comme des assemblages en fibre de verre, des hottes en aluminium ou des portes en plastique - appuyez simplement sur le GeckoPatch et continuez à utiliser vos aimants comme d'habitude.												
	<table border="1"> <tr> <th>Article n°:</th> <th>Box Label:</th> <th>Info:</th> </tr> <tr> <td>88247429</td> <td>YT16GPM002</td> <td>New</td> </tr> </table>	Article n°:	Box Label:	Info:	88247429	YT16GPM002	New	<table border="1"> <tr> <th>Dimensions</th> <th>Qtty/Pack:</th> <th>Unit Price:</th> </tr> <tr> <td>10 cm x 5 cm</td> <td>1</td> <td>14,9</td> </tr> </table>	Dimensions	Qtty/Pack:	Unit Price:	10 cm x 5 cm	1	14,9
Article n°:	Box Label:	Info:												
88247429	YT16GPM002	New												
Dimensions	Qtty/Pack:	Unit Price:												
10 cm x 5 cm	1	14,9												
	GeckoPatches S - U wilt niet-magnetische oppervlakken zoals glasvezela, aluminium of kunststof deuren "magnetisch" maken - druk gewoon op onze GeckoPatch en blijf uw magneten gebruiken zoals gewoonlijk.	GeckoPatches S. Vous voulez rendre "magnétiques" des surfaces non magnétiques comme des assemblages en fibre de verre, des hottes en aluminium ou des portes en plastique - appuyez simplement sur le GeckoPatch et continuez à utiliser vos aimants comme d'habitude.												
	<table border="1"> <tr> <th>Article n°:</th> <th>Box Label:</th> <th>Info:</th> </tr> <tr> <td>88300110</td> <td>YT16GPM001</td> <td>New</td> </tr> </table>	Article n°:	Box Label:	Info:	88300110	YT16GPM001	New	<table border="1"> <tr> <th>Dimensions</th> <th>Qtty/Pack:</th> <th>Unit Price:</th> </tr> <tr> <td>5 cm x 5 cm</td> <td>1</td> <td>9,9</td> </tr> </table>	Dimensions	Qtty/Pack:	Unit Price:	5 cm x 5 cm	1	9,9
Article n°:	Box Label:	Info:												
88300110	YT16GPM001	New												
Dimensions	Qtty/Pack:	Unit Price:												
5 cm x 5 cm	1	9,9												
	GeckoPatches L - U wilt niet-magnetische oppervlakken zoals glasvezela, aluminium of kunststof deuren "magnetisch" maken - druk gewoon op onze GeckoPatch en blijf uw magneten gebruiken zoals gewoonlijk.	GeckoPatches L Vous voulez rendre "magnétiques" des surfaces non magnétiques comme des assemblages en fibre de verre, des hottes en aluminium ou des portes en plastique - appuyez simplement sur le GeckoPatch et continuez à utiliser vos aimants comme d'habitude.												
	<table border="1"> <tr> <th>Article n°:</th> <th>Box Label:</th> <th>Info:</th> </tr> <tr> <td>88300111</td> <td>YT16GPM003</td> <td>New</td> </tr> </table>	Article n°:	Box Label:	Info:	88300111	YT16GPM003	New	<table border="1"> <tr> <th>Dimensions</th> <th>Qtty/Pack:</th> <th>Unit Price:</th> </tr> <tr> <td>10 cm x 10 cm</td> <td>1</td> <td>19,9</td> </tr> </table>	Dimensions	Qtty/Pack:	Unit Price:	10 cm x 10 cm	1	19,9
Article n°:	Box Label:	Info:												
88300111	YT16GPM003	New												
Dimensions	Qtty/Pack:	Unit Price:												
10 cm x 10 cm	1	19,9												



# CUTTING TOOLS









## ACCESSOIRES POUR LA DECOUPE

	OMSCHRIJVING			DESCRIPTION		
	Roestvrij stalen meetlat, 2-zijdige schaalverdeling - 30 cm			Réglet acier inox flexible gradué 2 faces - 30 cm		
	Article n°:	Box Label:	Info:	Dimensions	Qtty/Pack:	Unit Price:
	88103793	REGLET30	-	30 cm	1	5,07
	OMSCHRIJVING			DESCRIPTION		
	Roestvrij stalen meetlat, 2-zijdige schaalverdeling - 50 cm			Réglet acier inox flexible gradué 2 faces - 50 cm		
	Article n°:	Box Label:	Info:	Dimensions	Qtty/Pack:	Unit Price:
	88103794	REGLET50	-	50 cm	1	6,55
	OMSCHRIJVING			DESCRIPTION		
	Aluminium meetlat anti-slip			Règle plate antidérapante en aluminium - 80 cm		
	Article n°:	Box Label:	Info:	Dimensions	Qtty/Pack:	Unit Price:
	88103791	REGLE80	-	80 cm	1	55,12
	OMSCHRIJVING			DESCRIPTION		
	Snijtapijt			Tapis de découpe		
	Article n°:	Box Label:	Info:	Dimensions	Qtty/Pack:	Unit Price:
	2025613	TAPIS	🕒	90 x 62 cm	1	82,15
	OMSCHRIJVING			DESCRIPTION		
	Brede manuele applicator			Applicateur manuel large		
	Article n°:	Box Label:	Info:	Dimensions	Qtty/Pack:	Unit Price:
	74002596	Applier	-	125 cm	1	211,04
	OMSCHRIJVING			DESCRIPTION		
	Appfix 140 - Rollen gemonteerd op kogellagers zorgen voor het soepel afrollen - Inclusief montagebeugels Ontworpen voor eenvoudig gebruik door één persoon - De bevestigingsrem kan handmatig worden aangepast.			Appfix 140 - Rouleaux montés sur roulement à billes pour un roulement fluide - Comprend des supports de fixation. Conçu pour une utilisation facile par une seule personne - Le frein de fixation peut être réglé manuellement.		
	Article n°:	Box Label:	Info:	Dimensions	Qtty/Pack:	Unit Price:
	88309836	YT09AP140	New	140 cm.	1	139
	OMSCHRIJVING			DESCRIPTION		
	Appfix 160 - Rollen gemonteerd op kogellagers zorgen voor het voor het soepel afrollen - Inclusief montagebeugels - Ontworpen voor eenvoudig gebruik door één persoon - De bevestigingsrem kan handmatig worden aangepast.			Appfix 160 - Rouleaux montés sur roulement à billes pour un roulement fluide - Comprend des supports de fixation. Conçu pour une utilisation facile par une seule personne - Le frein de fixation peut être réglé manuellement.		
	Article n°:	Box Label:	Info:	Dimensions	Qtty/Pack:	Unit Price:
	88309838	YT09AP160	New	160 cm.	1	159
	OMSCHRIJVING			DESCRIPTION		
	SafetyRuler Platin - Linaal voor veilig snijden - Gemaakt van robuust aluminium - Geïntegreerde schuif - Handbeschermende randen - Antisliplaag - Nauwkeurige schaalverdeling.			SafetyRuler Platin - Règle pour couper en toute sécurité - Fabriqué en aluminium robuste - Glissière intégrée - Bords protégeant les mains - Revêtement antidérapant - Graduation précise.		
	Article n°:	Box Label:	Info:	Dimensions	Qtty/Pack:	Unit Price:
	88309851	YT09SRP100	New	1 m.	1	45,9

# CUTTING KNIVES CUTTERS DE DECOUPE









	OMSCHRIJVING			DESCRIPTION		
	Avery Plexi Cutter 30°			Cutter Avery en Plexi. Lame 30°		
	Article n°:	Box Label:	Info:	Dimensions	Qty/Pack:	Unit Price:
	88105491	CA6460001	-		5	5,79
	OMSCHRIJVING			DESCRIPTION		
	Avery Metallic Cutter 30°			Cutter Avery en métal. Lame 30°		
	Article n°:	Box Label:	Info:	Dimensions	Qty/Pack:	Unit Price:
	88105468	CA8140001	-		1	10,12
	OMSCHRIJVING			DESCRIPTION		
	Avery cuttermesjes 30°			Lames 30° pour cutter Avery		
	Article n°:	Box Label:	Info:	Dimensions	Qty/Pack:	Unit Price:
	540390	CA9090001	15 blades/Lames	3 units	45	38,33
	OMSCHRIJVING			DESCRIPTION		
	Avery - Snitty			Snitty Avery		
	Article n°:	Box Label:	Info:	Dimensions	Qty/Pack:	Unit Price:
	88105492	CA6420001	-	-	2	9,52
	OMSCHRIJVING			DESCRIPTION		
	10 Mesjes voor Olfa Cutter 30°			10 Lames pour Cutter Olfa 30°		
	Article n°:	Box Label:	Info:	Dimensions	Qty/Pack:	Unit Price:
	2025638	LAMOLFA30	-	-	1	7,00
	OMSCHRIJVING			DESCRIPTION		
	50 Mesjes Excel Olfa Zwart			50 Lames Olfa Excel Noir		
	Article n°:	Box Label:	Info:	Dimensions	Qty/Pack:	Unit Price:
	2025648	LAMOLFAXBL	-	-	1	15,89
	OMSCHRIJVING			DESCRIPTION		
	10 Mesjes voor Cutter Olfa Zilver			10 Lames pour Cutter Olfa Argent		
	Article n°:	Box Label:	Info:	Dimensions	Qty/Pack:	Unit Price:
	2025640	LAMOLFAS10	-	-	1	7,07
	OMSCHRIJVING			DESCRIPTION		
	50 Mesjes voor Cutter Olfa Zilver			50 Lames Cutter Olfa Argent		
	Article n°:	Box Label:	Info:	Dimensions	Qty/Pack:	Unit Price:
	2025647	LAMOLFAS50	-	-	1	31,03
	OMSCHRIJVING			DESCRIPTION		
	SHAGKNIFE - Snijder, ideaal voor het nauwkeurig snijden van vinyl voor en tijdens de installatie.			SHAGKNIFE - Cutter, idéal pour une découpe précise du vinyle avant et pendant la pose.		
	Article n°:	Box Label:	Info:	Dimensions	Qty/Pack:	Unit Price:
	88293301	Shagknife	New		1	5,87

# CUTTING KNIVES CUTTERS DE DECOUPE

	OMSCHRIJVING			DESCRIPTION		
	Cutter Olfa			Cutter Olfa		
	Article n°:	Box Label:	Info:	Dimensions	Qty/Pack:	Unit Price:
	88103769	CUTVITRE	-	-	1	4,23
	OMSCHRIJVING			DESCRIPTION		
	50 mesjes voor CUTVITRE			Paquet de 50 lames pour CUTVITRE		
	Article n°:	Box Label:	Info:	Dimensions	Qty/Pack:	Unit Price:
	2025622	CUTLAME	-	-	1	33,20
	OMSCHRIJVING			DESCRIPTION		
	Olfa Cutter 25°			Cutter Olfa 25°		
	Article n°:	Box Label:	Info:	Dimensions	Qty/Pack:	Unit Price:
	88169883	CUTOLFA25	🕒	-	1	21,35
	OMSCHRIJVING			DESCRIPTION		
	10 Mesjes voor Olfa Cutter 25°			10 Lames pour Cutter Olfa 25		
	Article n°:	Box Label:	Info:	Dimensions	Qty/Pack:	Unit Price:
	88169885	LAMOLFA25	🕒	-	1	7,54
	OMSCHRIJVING			DESCRIPTION		
	Accessoire met lange handle om de liner te versnijden			Accessoire pour la découpe du liner		
	Article n°:	Box Label:	Info:	Dimensions	Qty/Pack:	Unit Price:
	88169890	CUTVINYLXL	-	-	1	72,70
	OMSCHRIJVING			DESCRIPTION		
	SHAGCUT - Liner shaping tool.			SHAGCUT - Outil façonnage liner (refend liner).		
	Article n°:	Box Label:	Info:	Dimensions	Qty/Pack:	Unit Price:
	88293296	Shagcut	New	-	1	9,73
	OMSCHRIJVING			DESCRIPTION		
	Martor Snitty Cutter			Snitty Marto		
	Article n°:	Box Label:	Info:	Dimensions	Qty/Pack:	Unit Price:
	88147439	B CUTTERMAR	-	-	1	8,84
	OMSCHRIJVING			DESCRIPTION		
	TinnyCut - dun, lang snijdend mondstuk - supersterk en duurzaam Titan-Nitrid mes.			TinnyCut - mince, buse de guidage de coupe longue - lame Titan-Nitrid super-forte et durable.		
	Article n°:	Box Label:	Info:	Dimensions	Qty/Pack:	Unit Price:
	88309864	YT11TC001	New	80mm x 45mm x 3mm	5	3,59
	OMSCHRIJVING			DESCRIPTION		
	Maskeer- en positioneringstape			Tape de masquage et de positionnement		
	Article n°:	Box Label:	Info:	Dimensions	Qty/Pack:	Unit Price:
	88169894	N2TIRO19	-	19 mm x 50 m	1	1,79





# CUTTING KNIVES CUTTERS DE DECOUPE

	OMSCHRIJVING			DESCRIPTION		
	Maskeer- en positioneringstape			Tape de masquage et de positionnement		
	Article n°:	Box Label:	Info:	Dimensions	Qtty/Pack:	Unit Price:
88109485	N2TIRO25	-	25 mm x 50 m	1	1,79	
PAPYRUS 	OMSCHRIJVING			DESCRIPTION		
	Avery Stainless steel spare blade box			Boîte de lames Avery en acier inoxydable		
	Article n°:	Box Label:	Info:	Dimensions	Qtty/Pack:	Unit Price:
88261389	BM3290001			1	44,92	
	OMSCHRIJVING			DESCRIPTION		
	BladeBreaker II - Met de verwijderbare mesbehuizing kan u eenvoudig en veilig alle soorten messen breken en de restanten van het mes verdwijnen direct in de behuizing .			BladeBreaker II - Avec le boîtier de lame amovible, vous pouvez facilement et en toute sécurité casser toutes types de lames et faire disparaître les restes de lame directement à l'intérieur du boîtier.		
	Article n°:	Box Label:	Info:	Dimensions	Qtty/Pack:	Unit Price:
88309839	YT09BLB02	New	2.8cm x 1.20cm x 4.6cm	1	3,99	
	OMSCHRIJVING			DESCRIPTION		
	"BodyGuard" mes voor het snijden de liner zonder de folie te snijden. Een speciale Teflon-sticker verhoogt de slip en garandeert een precieze en veilige snede door de liner!			Couteau "BodyGuard" pour couper les liner sans couper le vinyl. Un autocollant spécial en téflon augmente le glissement et garantit une coupe précise et sûre à travers liner!		
	Article n°:	Box Label:	Info:	Dimensions	Qtty/Pack:	Unit Price:
88309840	YT11BGK001	New	10 spareblades included	5	24,9	
	OMSCHRIJVING			DESCRIPTION		
	BodyGuard Knife Duo HD voor het snijden in beide richtingen. Dit mes met grote handgreep is eenvoudig converteerbaar om folie te versnijden zowel via duwen en/of trekken.			BodyGuard Knife Duo HD pour couper dans les 2 sens. Ce couteau grand manche est facilement convertible afin de faire des coupes à pousser ou à tirer de vos vinyles		
	Article n°:	Box Label:	Info:	Dimensions	Qtty/Pack:	Unit Price:
88309841	YT12BGKDU-OHD	New		1	39,9	
	OMSCHRIJVING			DESCRIPTION		
	TitanBoquer CutCoaster 10er - Scherpe vervangbare messen met titanium coating. Extreem schoon - Zeer duurzaam - 4 bruikbare snijkanten - Geharde snijkanten - Met praktische dispenserdoos. Snijdiepte ca. 6-7 mm			TitanBlades CutCoaster 10er - Lames de rechange tranchantes avec revêtement en titane. Extrêmement nette - Très durable - 4 arrêtes de coupe utilisables - Tranchants durcis - Avec boîte distributrice pratique. Profondeur d'immersion env. 6-7 mm		
	Article n°:	Box Label:	Info:	Dimensions	Qtty/Pack:	Unit Price:
88309843	YT15TBCC04	New		5	14,9	
	OMSCHRIJVING			DESCRIPTION		
	LongReach Duo 60 ProTeflon. Lang mes voor het snijden van vinyl met Teflon-zolen.			LongReach Duo 60 ProTeflon. - Long couteau pour la découpe de vinyle avec semelles en téflon.		
	Article n°:	Box Label:	Info:	Dimensions	Qtty/Pack:	Unit Price:
88309848	YT15LRDPR60	New	60 cm.	1	59,9	
	OMSCHRIJVING			DESCRIPTION		
	LongReach Duo 90 ProTeflon. Lang teflon mes voor het snijden van folies			LongReach Duo 90 ProTeflon. - Long couteau pour la découpe de vinyle avec semelles en téflon.		
	Article n°:	Box Label:	Info:	Dimensions	Qtty/Pack:	Unit Price:
88309849	YT15LRDPR90	New	90 cm.	1	65,8	













## CUTTING KNIVES CUTTERS DE DECOUPE

	OMSCHRIJVING			DESCRIPTION		
	AngelCutter - Precieze snijkanten - Verstelbare snijbreedte 0,5 mm, 1,0 mm, 1,5 mm - Aan beide zijden bruikbaar - Verwisselbare messen			AngelCutter - Coupes des bord précis - Largeurs de coupe réglables 0,5 mm, 1,0 mm, 1,5 mm - Utilisable des deux côtés - Lames échangeables		
	Article n°:	Box Label:	Info:	Dimensions	Qtty/Pack:	Unit Price:
	88309835	YT15AC001	New		1	49,9
	OMSCHRIJVING			DESCRIPTION		
	TimberMaxx Wood-zuigmond 40 cm - Applicatie-zuigmond van extra groot, licht en supersterk gelamineerd hout.			TimberMaxx Wood Squeegee 40 cm - Racle d'application en bois lamellé extra-large légère et super solide.		
	Article n°:	Box Label:	Info:	Dimensions	Qtty/Pack:	Unit Price:
	88309860	YT13TMX040	New	40 cm.	1	24,9
	OMSCHRIJVING			DESCRIPTION		
	TimberMaxx Wood-zuigmond 60 cm - Applicatie-zuigmond van extra groot, licht en supersterk gelamineerd hout.			TimberMaxx Wood Squeegee 60 cm - Racle d'application en bois lamellé extra-large légère et super solide.		
	Article n°:	Box Label:	Info:	Dimensions	Qtty/Pack:	Unit Price:
	88309861	YT13TMX060	New	60 cm.	1	32,9
	OMSCHRIJVING			DESCRIPTION		
	TimberMaxx Wood Squeegee 80 cm - licht en supersterk gelamineerd hout.			TimberMaxx Wood Squeegee 80 cm - Racle d'application en bois lamellé extra-large légère et super solide.		
	Article n°:	Box Label:	Info:	Dimensions	Qtty/Pack:	Unit Price:
	88309863	YT13TMX080	New	80 cm.	1	42,9
	OMSCHRIJVING			DESCRIPTION		
	SignTrim Big - De randen van uw rigid media zijn binnen enkele seconden perfect glad met deze SignTrim "Big". Verwisselbare messen.			SignTrim Big - Les bords de vos panneaux rigides seront parfaitement lisses en quelques secondes avec ce SignTrim „Big“. Lames inter-changeables.		
	Article n°:	Box Label:	Info:	Dimensions	Qtty/Pack:	Unit Price:
	88309853	YT11STB001	New		1	14,99
	OMSCHRIJVING			DESCRIPTION		
	YelloCut HD Pro - Klassieke snijder voor het fijne werk en nauwkeurig werken bij het snijden van uw folies. Geschikte bladen: Titanbladen 9 mm 59° en reservebladen 9 mm 59°			YelloCut HD Pro - Cutter classique pour le "Fine-Tuning" et le travail précis lors de la découpe de vos vinyle. Lames appropriées: Lames Titan 9 mm 59° et Lames de rechange 9 mm 59°		
	Article n°:	Box Label:	Info:	Dimensions	Qtty/Pack:	Unit Price:
	88309874	YT16YCHDP01	New	Length: 130mm	5	7,99
	OMSCHRIJVING			DESCRIPTION		
	YelloCut SLIM - Deze kleine cutter voor het fijne werk biedt automatische vergrendeling, een zakclip en kan tot 8 kg contactdruk ondersteunen. Geschikt voor 9 mm 30° en 59° messen. Reservemessen: SpareBlades / TitanBlades / BlackBlades			YelloCut SLIM - Ce petit cutter pour une coupe mince propose un verrouillage automatique, un clip de poche et peut supporter jusqu'à 8 kg de pression de contact. Convient aux lames 9mm de 30° et 59°. Lames de rechange: SpareBlades / TitanBlades / BlackBlades		
	Article n°:	Box Label:	Info:	Dimensions	Qtty/Pack:	Unit Price:
	88309873	YT16YCS01	New	L	5	6,99
	OMSCHRIJVING			DESCRIPTION		
	SpareBlade Cera 59° - Pak van 5 59° keramische messen voor YelloCut messen.			SpareBlade Cera 59° - Pack de 5 lames de 59° en céramique pour les couteaux YelloCut.		
	Article n°:	Box Label:	Info:	Dimensions	Qtty/Pack:	Unit Price:
	88309871	YT17SBC59	New	59°	1	15,9









## CUTTING KNIVES CUTTERS DE DECOUPE

	OMSCHRIJVING			DESCRIPTION		
	SpareBlade Weeder 59 ° - 10 Ultrascherpe vervangende mesjes voor scalpel - compatibel met de volgende tools: BallpenWeeder, SingleWeeder en JanusWeeder.			SpareBlade Weeder 59 ° - 10 Lames de rechange ultra tranchantes pour scalpel - compatibles avec les outils suivants: BallpenWeeder, le SingleWeeder et le JanusWeeder.		
	Article n°:	Box Label:	Info:	Dimensions	Qty/Pack:	Unit Price:
88309875	YT09SB09	New	59°	1	1,99	
	OMSCHRIJVING			DESCRIPTION		
	TitanBlades 9mm 30° - 10 reservemessen 30° superscherp met een titanium oppervlaktecoating. Deze ultradunne laag verlengt de levensduur van de messen en zorgt voor uitstekende snij-precisie.			TitanBlades 9mm 30° - 10 Lames de rechange 30° super tranchantes avec un revêtement de surface en titane. Cette couche ultra mince prolonge la durée de vie des lames et assure une excellente précision de coupe.		
	Article n°:	Box Label:	Info:	Dimensions	Qty/Pack:	Unit Price:
88309876	YT11TB930	New	30°	1	4,99	

## VARIOUS ACCESSORIES ACCESSOIRES DIVERS







	OMSCHRIJVING			DESCRIPTION		
	Standaard dubbelzijdige tape, binnengebruik			Double face classique, usage intérieur		
	Article n°:	Box Label:	Info:	Dimensions	Qtty/Pack:	Unit Price:
	88169897	DOUBLEF25		25 mm x 50 m	1	4,07
	OMSCHRIJVING			DESCRIPTION		
	Standaard dubbelzijdige tape, binnengebruik			Double face classique, usage intérieur		
	Article n°:	Box Label:	Info:	Dimensions	Qtty/Pack:	Unit Price:
	88169899	DOUBLEF50		50 mm x 50 m	1	7,77
	OMSCHRIJVING			DESCRIPTION		
	Verstuiver inhoud 75 cl			Pulvérisateur contenance 75 cl		
	Article n°:	Box Label:	Info:	Dimensions	Qtty/Pack:	Unit Price:
	88103787	PULVERISAT	-	-	1	3,79
	OMSCHRIJVING			DESCRIPTION		
	spray bottle 1,2 l.			Bouteille de pulvérisation 1,2l.		
	Article n°:	Box Label:	Info:	Dimensions	Qtty/Pack:	Unit Price:
	88261393	BM3110001	-	-	1	39,72
	OMSCHRIJVING			DESCRIPTION		
	SPRAYBOX - sproeier van 1,5 liter.			SPRAYBOX - Pulvérisateur de 1,5L.		
	Article n°:	Box Label:	Info:	Dimensions	Qtty/Pack:	Unit Price:
	88293304	Spraybox	New, 		1	18
	OMSCHRIJVING			DESCRIPTION		
	Wit potlood te gebruiken op verschillende ondergronden zoals glas, metaal plastic. 12-pack			Crayon Blanc permettent d'écrire sur des supports variés tels que le verre, le métal, le plastique... 12 par boîte.		
	Article n°:	Box Label:	Info:	Dimensions	Qtty/Pack:	Unit Price:
	2025608	PENCILBLANC	-	12	1	18,92
	OMSCHRIJVING			DESCRIPTION		
	Blauw potlood te gebruiken op verschillende ondergronden zoals glas, metaal plastic. 12-pack			Crayon Bleu permettent d'écrire sur des supports variés tels que le verre, le métal, le plastique... 12 par boîte.		
	Article n°:	Box Label:	Info:	Dimensions	Qtty/Pack:	Unit Price:
	88103797	PENCILNOIR	-	12	1	18,92
	OMSCHRIJVING			DESCRIPTION		
	TwisterPaket 3" - Voor een optimale stockage voor uw rollen. Met deze twister kan u 9 rollen verticaal stockeren (Bevat ook 9 speedclips en 9 identificatieplaatjes)			Twister Paket 3" - Pour une meilleure solution de rangement de vos rouleaux. Ce twister vous permet de ranger 9 bobines verticalement. (Inclus également 9 serre-bobines et 9 plaque d'identification)		
	Article n°:	Box Label:	Info:	Dimensions	Qtty/Pack:	Unit Price:
	88309865	YT10TWP003	New		1	105,9
	OMSCHRIJVING			DESCRIPTION		
	Opti - Latex Handschoen - Large			Gant vinyle Opti Large (100/box)		
	Article n°:	Box Label:	Info:	Dimensions	Qtty/Pack:	Unit Price:
	653012	#	-	large	1	8,2

## VARIOUS ACCESSORIES ACCESSOIRES DIVERS









	OMSCHRIJVING			DESCRIPTION		
	Opti - Latex Handschoen - Extra Large			Gant vinyle Opti Extra Large (100/box)		
	Article n°:	Box Label:	Info:	Dimensions	Qtty/Pack:	Unit Price:
653013	#	-	extra large	1	8,2	
	OMSCHRIJVING			DESCRIPTION		
	Avery - Gereedschapsbelt (leeg)			Ceinture porte accessoires Avery (vide)		
	Article n°:	Box Label:	Info:	Dimensions	Qtty/Pack:	Unit Price:
88105490	CB0650001	-	-	1	33,32	
	OMSCHRIJVING			DESCRIPTION		
	YelloBelt ProWrap - Gereedschapsbelt zonder metalen delen De verdeelde vakken zijn geschikt voor sueegee's, pincetten, messen met breekbaar mes en bellenknoppen. Robuust nylon. 8 verschillende zakken. Extreem licht. Volledig hersluitbaar met klittenband. Metalen plaat genaaid om magneten te plaatsen.			YelloBelt ProWrap - CCeinture porte outil sans pièces métalliques. Les poches divisées sont dimensionnées pour les raclettes, les pincettes, les couteaux à lame cassable et les poppers à bulles. Tissu en nylon robuste. 8 poches différentes. Extrêmement léger. Entièrement refermable avec velcro. Plaque métallique cousue pour placer des aimants.		
	Article n°:	Box Label:	Info:	Dimensions	Qtty/Pack:	Unit Price:
88309869	YT09YB004	New	L: 17.5cm x W: 18,0cm x H: 2,5cm	5	19,9	
	OMSCHRIJVING			DESCRIPTION		
	WRAPBELT - Gereedschapsbelt			WRAPBELT - Ceinture porte-outils.		
	Article n°:	Box Label:	Info:	Dimensions	Qtty/Pack:	Unit Price:
88293308	Wrapbelt	New, 🕒		1	12,03	
	OMSCHRIJVING			DESCRIPTION		
	Rode speedclip voor rol - groot			Grand serre bobine rouge modèle		
	Article n°:	Box Label:	Info:	Dimensions	Qtty/Pack:	Unit Price:
88103772	DSERBORG M	-	-	50	53,17	
	OMSCHRIJVING			DESCRIPTION		
	Rode Speedclip voor rol - klein			Petit serre bobine rouge modèle		
	Article n°:	Box Label:	Info:	Dimensions	Qtty/Pack:	Unit Price:
88103773	DSERBORPM	-	-	50	40,9	
	OMSCHRIJVING			DESCRIPTION		
	ID Tab voor uw open rollen in stockage (10 st.)			Onglet de repérage pour bobines. Paquet de 10.		
	Article n°:	Box Label:	Info:	Dimensions	Qtty/Pack:	Unit Price:
88143449	HEXNOTE10	🕒	-	10	19,61	
	OMSCHRIJVING			DESCRIPTION		
	EasyUp - Zuignap waarmee u gemakkelijk grote panelen veilig kunt vervoeren. Licht (350 g) maar super stevig. Alle bewegende delen zijn van metaal voor een langere levensduur. De met rubber gecoatete zuignap voorkomt dat uw paneel beschadigt wordt.			EasyUp - Ventouse vous permettant de transporter facilement de grands panneaux en toute sécurité. Léger (350g) mais super solide. Toutes les pièces mobiles sont métalliques pour une plus longue durée de vie. La ventouse recouverte de caoutchouc empêche les particules et la saleté d'endommager votre panneau.		
	Article n°:	Box Label:	Info:	Dimensions	Qtty/Pack:	Unit Price:
88309846	YT06EU001	New		1	9,99	











## VARIOUS ACCESSORIES ACCESSOIRES DIVERS

	OMSCHRIJVING			DESCRIPTION		
	SignToolBox - De opbergtas bevat een afneembare hoes - Extreem duurzaam materiaal - Inclusief een schouderriem - Geïntegreerde metalen plaat om de magneten te bevestigen.			SignToolBox - Le sac de rangement comprend une housse amovible - Matériau extrêmement durable- Comprend une bandoulière - Plaque métallique intégrée pour fixer les aimants.		
	Article n°:	Box Label:	Info:	Dimensions	Qty/Pack:	Unit Price:
	88309852	YT06STB01	New	L: 43 cm x B: 25 cm x H: 25 cm.	5	39,9
	OMSCHRIJVING			DESCRIPTION		
	EasyMedia-lift - De zware roestvrijstalen plaat heft zelfs zware media met gemak op. De handgreep biedt maximaal koppel en comfort.			Porte Bobines - La plaque robuste en acier inoxydable soulève facilement les médias lourds. La poignée offre un couple et un confort maximum.		
	Article n°:	Box Label:	Info:	Dimensions	Qty/Pack:	Unit Price:
	88309845	YT12EML01	New		1	39,9
	OMSCHRIJVING			DESCRIPTION		
	TWEEZ - Kan worden gebruikt op snijfolie, printmedia, FLEX en andere producten waarvoor wieden vereist is.			TWEEZ - S'utilise sur vinyles DAO ou IMN, FLEX et autres produits nécessitant un échenillage.		
	Article n°:	Box Label:	Info:	Dimensions	Qty/Pack:	Unit Price:
	88293306	Tweez	New, ⌚		1	3,73
	OMSCHRIJVING			DESCRIPTION		
	SignTweezer Straight L- Het slanke profiel van de punt en de stijve uiteinden zorgen voor eenvoudig wieden. Evenwichtige tipspanning voor eenvoudig gebruik - Beschermkap voor veilige opslag.			SignTweezer Straight L Le profil élancé de la pointe et les bouts rigides permettent un échenillage facile. Tension équilibrée des pointes pour une utilisation aisée - Capuchon de protection pour un stockage sécurisé.		
	Article n°:	Box Label:	Info:	Dimensions	Qty/Pack:	Unit Price:
	88309854	YT05ST001	New	13 cm.	10	4,99
	OMSCHRIJVING			DESCRIPTION		
	SignTweezer Straight XS- Het slanke profiel van de punt en de stijve uiteinden zorgen voor eenvoudig wieden. Evenwichtige tipspanning voor eenvoudig gebruik - Beschermkap voor veilige opslag.			SignTweezer Straight XS- Le profil élancé de la pointe et les bouts rigides permettent un échenillage facile. Tension équilibrée des pointes pour une utilisation aisée - Capuchon de protection pour un stockage sécurisé.		
	Article n°:	Box Label:	Info:	Dimensions	Qty/Pack:	Unit Price:
	88309855	YT10STXS1	New	8,5 cm	10	4,99
	OMSCHRIJVING			DESCRIPTION		
	YelloPen - De bellenknipper die eruit ziet, werkt en klikt als een pen! Bovendien kan de tip veilig worden opgeslagen met één klik.			YelloPen - Le popper à bulles qui ressemble, fonctionne et clique comme un stylo! De plus, la pointe se range en toute sécurité en un seul clic.		
	Article n°:	Box Label:	Info:	Dimensions	Qty/Pack:	Unit Price:
	88309880	YT09YP001	New		5	9,9
	OMSCHRIJVING			DESCRIPTION		
	Wiedhaak			Crochet d'échenillage		
	Article n°:	Box Label:	Info:	Dimensions	Qty/Pack:	Unit Price:
	247076	WEEDER	-	-	1	13,51

# ACCESSOIRES FOR SOLAR FILMS ACCESSOIRES POUR FILMS SOLAIRES





	OMSCHRIJVING			DESCRIPTION		
	Rolmeter			Mètre déroulant		
	Article n°:	Box Label:	Info:	Dimensions	Qtty/Pack:	Unit Price:
	2025618	DMTRUBFR	-	-	1	9,34
	OMSCHRIJVING			DESCRIPTION		
	Squeegee voor vensters			Raclette pour vitre		
	Article n°:	Box Label:	Info:	Dimensions	Qtty/Pack:	Unit Price:
	247033	MARVITRE	-	-	1	1,10
	OMSCHRIJVING			DESCRIPTION		
	Soft squeegee			Raclette Souple		
	Article n°:	Box Label:	Info:	Dimensions	Qtty/Pack:	Unit Price:
	247029	MARBLEU	-	-	1	3,39
	OMSCHRIJVING			DESCRIPTION		
	Medium Squeegee			Raclette Médium		
	Article n°:	Box Label:	Info:	Dimensions	Qtty/Pack:	Unit Price:
	247032	MAROR	-	-	1	3,39
	OMSCHRIJVING			DESCRIPTION		
	Harde Squeegee			Raclette Dure		
	Article n°:	Box Label:	Info:	Dimensions	Qtty/Pack:	Unit Price:
	247031	MARNOIR	-	-	1	3,45
	OMSCHRIJVING			DESCRIPTION		
	SHAGBODY - Standaard squeegee voor het aanbrengen van Bodyfence en zonwerende films.			SHAGBODY - Raclette standard pour application du Bodyfence et de films de protection solaire.		
	Article n°:	Box Label:	Info:	Dimensions	Qtty/Pack:	Unit Price:
	88293294	Shagbody	New		1	3,79
	OMSCHRIJVING			DESCRIPTION		
	SHAGFENCEM - Squeegee speciaal ontworpen voor het aanbrengen van Bodyfence en zonwerende films			SHAGFENCEM - Raclettes spécialement conçues pour la pose du Bodyfence et de films de protection solaire		
	Article n°:	Box Label:	Info:	Dimensions	Qtty/Pack:	Unit Price:
	88293299	Shagfencem	New	15 cm.	1	9,73
	OMSCHRIJVING			DESCRIPTION		
	SHAGFENCES - Squeegee speciaal ontworpen voor het aanbrengen van Bodyfence en zonwerende films.			SHAGFENCES - Raclettes spécialement conçues pour la pose du Bodyfence et de films de protection solaire.		
	Article n°:	Box Label:	Info:	Dimensions	Qtty/Pack:	Unit Price:
	88293300	Shagfences	New	9,5 cm.	1	5,87
	OMSCHRIJVING			DESCRIPTION		
	Medium squeegee voor raamdichtingen			Racle medium pour joints de vitres		
	Article n°:	Box Label:	Info:	Dimensions	Qtty/Pack:	Unit Price:
	247068	PIADZROUGE	-	-	1	6,41

# ACCESSOIRES FOR SOLAR FILMS ACCESSOIRES POUR FILMS SOLAIRES

	OMSCHRIJVING			DESCRIPTION		
	Harde squeegee voor raamdichtingen			Raclette dure pour joints de vitres		
	Article n°:	Box Label:	Info:	Dimensions	Qty/Pack:	Unit Price:
	88169901	PIADZGREY	🕒	-	1	8,55
	OMSCHRIJVING			DESCRIPTION		
	Blad van raamwisser in roestvrij staal en zwarte rubber			Lame raclette vitre en acier inoxydable et caoutchouc noir		
	Article n°:	Box Label:	Info:	Dimensions	Qty/Pack:	Unit Price:
	88103804	LAMEVITR15	-	15 cm	1	6,42
	OMSCHRIJVING			DESCRIPTION		
	Blad van raamwisser in roestvrij staal en zwarte rubber			Lame raclette vitre en acier inoxydable et caoutchouc noir		
	Article n°:	Box Label:	Info:	Dimensions	Qty/Pack:	Unit Price:
	88169902	LAMEVITRE	🕒	20 cm	1	8,6
	OMSCHRIJVING			DESCRIPTION		
	Blad van raamwisser in roestvrij staal en zwarte rubber			Lame raclette vitre en acier inoxydable et caoutchouc noir		
	Article n°:	Box Label:	Info:	Dimensions	Qty/Pack:	Unit Price:
	2025635	LAMEVITR30	🕒	30 cm	1	11,77
	OMSCHRIJVING			DESCRIPTION		
				Raclette d'application pour films sur lunette arrière		
	Article n°:	Box Label:	Info:	Dimensions	Qty/Pack:	Unit Price:
	247004	BERLAP	-	-	1	36,01
	OMSCHRIJVING			DESCRIPTION		
	POIGNVITR - Handgreep compatibel met LAMEVITR en MAXBLUE			POIGNVITR - Poignée pour lame de nettoyage compatible avec LAMEVITR et MAXBLUE		
	Article n°:	Box Label:	Info:	Dimensions	Qty/Pack:	Unit Price:
	88293292	Poignvitr	New - 🕒		1	15,22
	OMSCHRIJVING			DESCRIPTION		
	MAXBLUE - Zeer flexibele Teflon-wisser voor de applicatie van zonerende films.			MAXBLUE - Raclette très souple en téflon pour pose de films solaires.		
	Article n°:	Box Label:	Info:	Dimensions	Qty/Pack:	Unit Price:
	88293290	Maxblue	New - 🕒		1	8,6
	OMSCHRIJVING			DESCRIPTION		
	IvoCut. Het mes voor venster visuals.			IvoCut. Le couteau pour les visuals de fenêtres.		
	Article n°:	Box Label:	Info:	Dimensions	Qty/Pack:	Unit Price:
	88309847	YT09IC01	New	20 cm x 20 cm	1	39,9
	OMSCHRIJVING			DESCRIPTION		
	MAXHANDLE - Mouw voor MAXBLUE			MAXHANDLE - Manche pour MAXBLUE		
	Article n°:	Box Label:	Info:	Dimensions	Qty/Pack:	Unit Price:
	88239057	MAXHANDLE	New, 🕒		1	30,58











## ACCESSOIRES FOR SOLAR FILMS ACCESSOIRES POUR FILMS SOLAIRES

	OMSCHRIJVING			DESCRIPTION		
	Metalen intrekbare schraper voor LAME100			Grattoir métal rétractable pour LAME100		
	Article n°:	Box Label:	Info:	Dimensions	Qty/Pack:	Unit Price:
	88166498	GRATLAM100			1	17,45
	OMSCHRIJVING			DESCRIPTION		
	Mesjes in roestvrij staal 100 pcs - 1" edge			Lames en acier 100 pcs - 1" edge		
	Article n°:	Box Label:	Info:	Dimensions	Qty/Pack:	Unit Price:
	88103801	LAME100	-	-	1	11,6
	OMSCHRIJVING			DESCRIPTION		
	Olfa Scraper met blad van 6"			Grattoir à vitre Olfa avec lame de 6"		
	Article n°:	Box Label:	Info:	Dimensions	Qty/Pack:	Unit Price:
	88169927	Scrubfloor	-	-	1	46,04
	OMSCHRIJVING			DESCRIPTION		
	Scrapper voor autoruiten - 10 pcs			Scrapper pour fenêtres de voitures, avant application		
	Article n°:	Box Label:	Info:	Dimensions	Qty/Pack:	Unit Price:
	88103774	GRATTOIR10	🕒	-	1	13,23
	OMSCHRIJVING			DESCRIPTION		
	SHAGCHIZ - Afwerkingssqueegee voor automotiv zonwerende films.			SHAGCHIZ - Raclette de finition pour film solaire auto.		
	Article n°:	Box Label:	Info:	Dimensions	Qty/Pack:	Unit Price:
	88293295	Shagchiz	New		1	0,98



# WRAP TOOLS and ACCESSORIES ACCESSOIRES POUR TOTAL COVERING

	OMSCHRIJVING			DESCRIPTION		
	Avery Magneten			Aimants Avery		
	Article n°:	Box Label:	Info:	Dimensions	Qtty/Pack:	Unit Price:
88105489	CA6400001	-	price/set	2	32,39	
	OMSCHRIJVING			DESCRIPTION		
	Dit microfiberpakket helpt u om vuil van al uw delicate oppervlakken te verwijderen zonder sporen en zonder het risico van krassen achter te laten, maar vooral zonder de producten te mengen tijdens het reinigen.			Ce pack de microfibres vous aidera à désincruster la saleté sur toutes vos surfaces filmées sans laisser de traces et sans risque de rayures mais surtout sans mélanger les produits lors du nettoyage.		
	Article n°:	Box Label:	Info:	Dimensions	Qtty/Pack:	Unit Price:
88273083	MF kit	🕒 - New	40 cm. X 40 cm.	1	17,89	
	OMSCHRIJVING			DESCRIPTION		
	Lederen gereedschapsarmband			Bracelet cuir porte-outils		
	Article n°:	Box Label:	Info:	Dimensions	Qtty/Pack:	Unit Price:
2025605	MANCHETTE3	-	-	1	49,44	
	OMSCHRIJVING			DESCRIPTION		
	Thermisch pistool			Pistolet thermique		
	Article n°:	Box Label:	Info:	Dimensions	Qtty/Pack:	Unit Price:
88103784	PISTHERMIQ	-	-	1	98,58	
	OMSCHRIJVING			DESCRIPTION		
	Laserthermometer			Pistolet laser pour vérifier la température		
	Article n°:	Box Label:	Info:	Dimensions	Qtty/Pack:	Unit Price:
88103785	PISTLASER3	-	-	1	92,09	
	OMSCHRIJVING			DESCRIPTION		
	Magneet met verwijderbaar handvat voor eenvoudige stockage			Aiment avec poignet enlevable pour facilité le stockage		
	Article n°:	Box Label:	Info:	Dimensions	Qtty/Pack:	Unit Price:
2025778	AIMANT2	-	-	1	5,24	
	OMSCHRIJVING			DESCRIPTION		
	Magneet XL			Aiment XL		
	Article n°:	Box Label:	Info:	Dimensions	Qtty/Pack:	Unit Price:
88169914	AIMANTXL	-	-	1	15,22	
	OMSCHRIJVING			DESCRIPTION		
	SpeedMag HD - Maakt het mogelijk om folie zonder hulp aan te brengen - Verhoogt de werksnelheid en garandeert een betere kwaliteit. Krast het oppervlak niet - Extreem sterke magnetische kracht... Afmetingen van de magnetische plaat 43x6mm - Maximale bedrijfstemperatuur 60 ° C.			SpeedMag HD - Permet l'application du vinyle sans assistance - Augmente la vitesse de travail et garantit une meilleure qualité N'égratigne pas la surface - Puissance magnétique extrêmement forte. Dimensions de la plaque magnétique 43x6mm - Température de fonctionnement maximale 60 ° C.		
	Article n°:	Box Label:	Info:	Dimensions	Qtty/Pack:	Unit Price:
88309856	YT08SMHD01	New	Ø 43	10	6,99	
	OMSCHRIJVING			DESCRIPTION		
	Hexmagnet - Magneten met stofbescherming			Hexmagnet - Aimants avec Protection tissu		
	Article n°:	Box Label:	Info:	Dimensions	Qtty/Pack:	Unit Price:
88293283	Hexmagnet	New, 🕒		1	18,25	



# WRAP TOOLS and ACCESSORIES ACCESSOIRES POUR TOTAL COVERING

	OMSCHRIJVING			DESCRIPTION		
	Hexstrap - Magnetische riem			Hexstrap - Sangle Magnétique		
	Article n°:	Box Label:	Info:	Dimensions	Qty/Pack:	Unit Price:
	88293285	Hexstrap	New, 🕒		1	34,12
	OMSCHRIJVING			DESCRIPTION		
	Kruk voor wrapping			Tabouret pour recouvrement de véhicule		
	Article n°:	Box Label:	Info:	Dimensions	Qty/Pack:	Unit Price:
	2025617	COVSEAT4	-	-	1	94,03
	OMSCHRIJVING			DESCRIPTION		
	Aandrukwiël voor carwrap			Roulette d'application pour le Total Covering		
	Article n°:	Box Label:	Info:	Dimensions	Qty/Pack:	Unit Price:
	88103807	ROLLCOV	-	-	1	23,05
	OMSCHRIJVING			DESCRIPTION		
	Aandrukwiël voor toepassingen op ringen			Roulette d'application pour pose sur rivets		
	Article n°:	Box Label:	Info:	Dimensions	Qty/Pack:	Unit Price:
	88169915	ROLLRIV	🕒	-	1	110,97
	OMSCHRIJVING			DESCRIPTION		
	Zeer fijne positioneringstape			Tape de pose très fin.		
	Article n°:	Box Label:	Info:	Dimensions	Qty/Pack:	Unit Price:
	88103798	TIRO DECO	-	6 mm x 33 m.	1	9,98
	OMSCHRIJVING			DESCRIPTION		
	Tape "zonder snijden" groen			Tape "Sans Coupe" vert		
	Article n°:	Box Label:	Info:	Dimensions	Qty/Pack:	Unit Price:
	2028778	FILDEC03	-	3,5 mm x 50 m	1	40,97
	OMSCHRIJVING			DESCRIPTION		
	Finishing hook Om de moeilijkste plaatsen te bereiken			Crochet définition Permet d'accéder aux endroits les plus difficiles		
	Article n°:	Box Label:	Info:	Dimensions	Qty/Pack:	Unit Price:
	88169953	HEXCROCH	-	-	1	30,68
	OMSCHRIJVING			DESCRIPTION		
	Full wrap weeder			Pince bout rond pour covering		
	Article n°:	Box Label:	Info:	Dimensions	Qty/Pack:	Unit Price:
	88169921	FLATTWEEZ	-		1	4,18
	OMSCHRIJVING			DESCRIPTION		
	Vloer en raam schrobber			Grattoir pour sol et vitre		
	Article n°:	Box Label:	Info:	Dimensions	Qty/Pack:	Unit Price:
	88169927	SCRUBFLOOR	-	-	1	46,04

# WRAP TOOLS and ACCESSORIES ACCESSOIRES POUR TOTAL COVERING









	OMSCHRIJVING			DESCRIPTION		
	Blades voor SCRUBFLOOR			Lames pour SCRUBFLOOR		
	Article n°:	Box Label:	Info:	Dimensions	Qty/Pack:	Unit Price:
	88169929	SCRUBBLADE	-	-	1	11,29
	OMSCHRIJVING			DESCRIPTION		
	Borstel voor applicatie op rivetten			Brosse application sur rivet		
	Article n°:	Box Label:	Info:	Dimensions	Qty/Pack:	Unit Price:
	88169931	RIVETBRUSH	🕒		1	10,03
	OMSCHRIJVING			DESCRIPTION		
	Kit met scraper en 25 blades			Kit grattoir +25 lames polycarbonate		
	Article n°:	Box Label:	Info:	Dimensions	Qty/Pack:	Unit Price:
	88169932	CARSCRAPER	-		1	15,05
	OMSCHRIJVING			DESCRIPTION		
	Gestandaardiseerde clips			Kit ôte agrafes normés		
	Article n°:	Box Label:	Info:	Dimensions	Qty/Pack:	Unit Price:
	88169933	STRIKERSET	End of stock		1	67,69
	OMSCHRIJVING			DESCRIPTION		
	NINJATOOL - Tool die helpt om de film in de ruitenwissers te plaatsen.			NINJATOOL - Outil qui aide à passer le film dans les lèche-vitres.		
	Article n°:	Box Label:	Info:	Dimensions	Qty/Pack:	Unit Price:
	88293291	Ninjatool	New, 🕒		1	3,8
	OMSCHRIJVING			DESCRIPTION		
	Plateline Remover - Dit extreem scheurbestendige snoer is perfect voor het verwijderen van resten zonder de verf te beschadigen. De snelkoppelingshendel zorgt ervoor dat u het "zaagkoord" in seconden kunt aanpassen.			Plateline Remover - Ce cordon extrêmement résistant à la déchirure est parfait pour éliminer les résidus sans endommager la peinture. La poignée à dégagement rapide garantit que vous pouvez régler le «cordon de scie» en quelques secondes.		
	Article n°:	Box Label:	Info:	Dimensions	Qty/Pack:	Unit Price:
	88309850	YT12PLR01	New		1	39,9
	OMSCHRIJVING			DESCRIPTION		
	SHAGWIRE - Zeer resistente draad voor het eenvoudig verwijderen van badges, logo's en markeringen op voertuigen - zonder de carrosserie te beschadigen.			SHAGWIRE - Fil très résistant permettant la dépose facile des insignes, logos et marquages sur les véhicules – sans abîmer la carrosserie.		
	Article n°:	Box Label:	Info:	Dimensions	Qty/Pack:	Unit Price:
	88293303	Shagwire	New		1	24,34
	OMSCHRIJVING			DESCRIPTION		
	Avery SWF Display 80 cm x 64 cm.			Présentoir SWF Avery -		
	Article n°:	Box Label:	Info:	Dimensions	Qty/Pack:	Unit Price:
	88203395	BL2470001	End of stock	63 x 121 cm.	1	158,89
	OMSCHRIJVING			DESCRIPTION		
	Avery SWF Display with 3D Shapes and 2 swatches			Présentoir SWF Avery avec formes 3D et 2 nuanciers 80 cm x 64 cm.		
	Article n°:	Box Label:	Info:	Dimensions	Qty/Pack:	Unit Price:
	88242368	BL2470002	🕒	80 cm x 64 cm.	1	158,89

# WRAP TOOLS and ACCESSORIES ACCESSOIRES POUR TOTAL COVERING

	OMSCHRIJVING			DESCRIPTION		
	Witte katoenen handschoenen			Gants blancs en coton		
	Article n°:	Box Label:	Info:	Dimensions	Qty/Pack:	Unit Price:
	247022	GANTSIMN		Uni Size	2	3,09
	OMSCHRIJVING			DESCRIPTION		
	Wrapping handschoen			Gant de covering		
	Article n°:	Box Label:	Info:	Dimensions	Qty/Pack:	Unit Price:
	247021	GANTSCOV	-	Uni Size	2	3,12
	OMSCHRIJVING			DESCRIPTION		
	YelloGloves Pro X S/M - Toepassing handschoenen voor carwrapping met hoge glij-eigenschappen.			YelloGloves PRO-X S/M - Gants d'application pour carwrapping avec des propriétés de glissement élevées.		
	Article n°:	Box Label:	Info:	Dimensions	Qty/Pack:	Unit Price:
	88309877	YT17YG PX01	New	sizes s and m	1	12,9
	OMSCHRIJVING			DESCRIPTION		
	Temper „ProWrap“					
	Article n°:	Box Label:	Info:	Dimensions	Qty/Pack:	Unit Price:
	88309859	YT10TPW01	New		1	69,9
	OMSCHRIJVING			DESCRIPTION		
	Avery Handschoen naadloos			Gant Avery sans coutures		
	Article n°:	Box Label:	Info:	Dimensions	Qty/Pack:	Unit Price:
	540013	BN6260001	-	Uni Size	1	10,01
	OMSCHRIJVING			DESCRIPTION		
	YelloBrush - Voor fans van two-in-one tools, kunt u met deze klinknagelborstel het vinyl borstelen en boren wanneer u op klinknagels legt.			YelloBrush - Pour les accros aux outils deux en un, cette brosse à rivets vous permet de brosser et percer le vinyle lors de la pose sur rivets.		
	Article n°:	Box Label:	Info:	Dimensions	Qty/Pack:	Unit Price:
	88309870	YT10YB001	New		5	14,99

# BANNER TOOLS and ACCESSOIRES



## ACCESSOIRES POUR BACHES

	OMSCHRIJVING			DESCRIPTION		
	Eyelet manual press kit (pers, 1000 eyelets, ponstang 10 mm)			Kit pour percer et sertir (presse, 1000 œillets, sertissage 10 mm)		
	Article n°:	Box Label:	Info:	Dimensions	Qtty/Pack:	Unit Price:
	88103776	KITPRESSE	-	-	1	182,39
	OMSCHRIJVING			DESCRIPTION		
	Messing eyelets			Œillets en Laiton		
	Article n°:	Box Label:	Info:	Dimensions	Qtty/Pack:	Unit Price:
	88169934	OEILLET10L	🕒	Ø 10 mm	1000	56,60
	OMSCHRIJVING			DESCRIPTION		
	Nikkel eyelets			Œillets en nickel		
	Article n°:	Box Label:	Info:	Dimensions	Qtty/Pack:	Unit Price:
	88103781	OEILLET10N	-	Ø 10 mm	1000	62,55
	OMSCHRIJVING			DESCRIPTION		
	Messing eyelets			Œillets en laiton		
	Article n°:	Box Label:	Info:	Dimensions	Qtty/Pack:	Unit Price:
	88169935	OEILLET12L	🕒	Ø 12 mm	500	50,65
	OMSCHRIJVING			DESCRIPTION		
	Nikkel eyelets			Œillets en Nickel		
	Article n°:	Box Label:	Info:	Dimensions	Qtty/Pack:	Unit Price:
	88103782	OEILLET12N	-	Ø 12 mm	500	56,60
	OMSCHRIJVING			DESCRIPTION		
	Messing eyelets			Œillets en laiton		
	Article n°:	Box Label:	Info:	Dimensions	Qtty/Pack:	Unit Price:
	88169936	OEILLET15L	🕒	Ø 15 mm	250	47,70
	OMSCHRIJVING			DESCRIPTION		
	Nikkel eyelets			Œillets en nickel		
	Article n°:	Box Label:	Info:	Dimensions	Qtty/Pack:	Unit Price:
	88103783	OEILLET15N	-	Ø 15 mm	250	53,65
	OMSCHRIJVING			DESCRIPTION		
	Adapter voor eyelets 10 mm			Jeu de sertissage 10 mm		
	Article n°:	Box Label:	Info:	Dimensions	Qtty/Pack:	Unit Price:
	2025592	JEUSERT10	-	-	1	53,57
	OMSCHRIJVING			DESCRIPTION		
	Adapter voor eyelets 12 mm			Jeu de sertissage 12 mm		
	Article n°:	Box Label:	Info:	Dimensions	Qtty/Pack:	Unit Price:
	88103789	JEUSERT12	-	-	1	57,37



# BANNER TOOLS and ACCESSOIRES

## ACCESSOIRES POUR BACHES

	OMSCHRIJVING			DESCRIPTION		
	Adapter voor eyelets 15 mm			Jeu de sertissage 15 mm		
	Article n°:	Box Label:	Info:	Dimensions	Qty/Pack:	Unit Price:
88103790	JEUSERT15	-	-	1	65,03	
	OMSCHRIJVING			DESCRIPTION		
	Tape voor de afdichting van banners			Tape pour scellement de bâches		
	Article n°:	Box Label:	Info:	Dimensions	Qty/Pack:	Unit Price:
2025611	STRONGBAN3	-	25 mm x 50 m	1	73,95	
	OMSCHRIJVING			DESCRIPTION		
	Opti Spanner met haak			Opti Tendeur avec crochet		
	Article n°:	Box Label:	Info:	Dimensions	Qty/Pack:	Unit Price:
535105	#	-	20 cm	50	0,9	
	OMSCHRIJVING			DESCRIPTION		
	Opti Strong banner tape			Opti Strong banner tape		
	Article n°:	Box Label:	Info:	Dimensions	Qty/Pack:	Unit Price:
88103932	#	-	25 mm x 25 m	1	29,31	
	OMSCHRIJVING			DESCRIPTION		
	Opti Strong banner tape			Opti Strong banner tape		
	Article n°:	Box Label:	Info:	Dimensions	Qty/Pack:	Unit Price:
88103933	#	-	40 mm x 25 m	1	43,87	

# LIQUIDS LIQUIDES

	OMSCHRIJVING			DESCRIPTION		
	Avery Surface Cleaner voor het ontvetten en reinigen.			Avery Surface pour dégraisser et nettoyer		
	Article n°:	Box Label:	Info:	Dimensions	Qtty/Pack:	Unit Price:
	540014	CA3750001	-	6 x 1 L	1	67,38
	OMSCHRIJVING			DESCRIPTION		
	Avery Flat Surface Cleaner voor het ontvetten en van vlakke oppervlakken.			Avery Flat Surface pour dégraisser, nettoyer les surfaces planes		
	Article n°:	Box Label:	Info:	Dimensions	Qtty/Pack:	Unit Price:
	2028763	CB1380001	🕒 min. 1 Box	Box 4 x 5 L	1	144,66
	OMSCHRIJVING			DESCRIPTION		
	Avery Adhesive Remover om lijm te verwijderen.			Avery Adhesive Remover pour enlever la colle		
	Article n°:	Box Label:	Info:	Dimensions	Qtty/Pack:	Unit Price:
	540365	CA6970001	-	6 x 500 ml	1	136,79
	OMSCHRIJVING			DESCRIPTION		
	Avery Cleaner 6 x 946ml			Avery Cleaner 6 x 946ml		
	Article n°:	Box Label:	Info:	Dimensions	Qtty/Pack:	Unit Price:
	88166749	BC2480001	-	box 6 x 946 ml	1	114,56
	OMSCHRIJVING			DESCRIPTION		
	Avery Power Cleaner 6 x 946ml			Avery Power Cleaner 6 x 946ml		
	Article n°:	Box Label:	Info:	Dimensions	Qtty/Pack:	Unit Price:
	88166748	BC2510001	-	box 6 x 946 ml	1	126,02
	OMSCHRIJVING			DESCRIPTION		
	Avery Sealant 6 x 946ml			Avery Sealant 6 x 946ml		
	Article n°:	Box Label:	Info:	Dimensions	Qtty/Pack:	Unit Price:
	88166750	BC2570001	-	box 6 x 946 ml	1	126,02
	OMSCHRIJVING			DESCRIPTION		
	Avery SWF Care Sample Kit			Avery SWF Care Sample Kit		
	Article n°:	Box Label:	Info:	Dimensions	Qtty/Pack:	Unit Price:
	88228994	BI9470001	-	3 x 118 ml + Towel	1	27,30
	OMSCHRIJVING			DESCRIPTION		
	SHAGCLEAN - OPPERVLAKTEAFWERKING Nieuwe formulering: droogt sneller en vereist minder reiniging met microvezeldoek van het oppervlak. Optimaal formaat - transparante spray: gemakkelijk te vervoeren en te gebruiken (eenvoudig zicht op de hoeveelheid resterende vloeistof). Beschikbaar in 1L spuitformaat			SHAGCLEAN - FINITION DE LA SURFACE Nouvelle formulation : sèche plus rapidement et nécessite moins de passage microfibre sur la surface. Format optimal – spray transparent : facile à transporter et à utiliser (vision facile de la quantité de liquide restant). Disponible en format spray 1L		
	Article n°:	Box Label:	Info:	Dimensions	Qtty/Pack:	Unit Price:
	88293309	Shagclean	New		1	12,36



# LIQUIDS LIQUIDES

	OMSCHRIJVING			DESCRIPTION		
	SHAGREMOV - Krachtig reinigingsmiddel voor het verwijderen van lijmresten en andere afzettingen (teer, bitumen, olie, vet, vuil van graffiti ...). Bedoeld voor het reinigen van carrosserie om een total wrap voor te bereiden.			SHAGREMOV - Agent de nettoyage puissant permettant d'éliminer les résidus de colle, et autres dépôts (goudron, bitume, huile, graisse, salissures provenant de graffitis...). Destiné au nettoyage des carrosseries pour préparation d'un total-covering		
	Article n°:	Box Label:	Info:	Dimensions	Qtty/Pack:	Unit Price:
	88293311	Shagremov	New		1	35,15
	OMSCHRIJVING			DESCRIPTION		
	Applicatievloeistof 5L			Liquide d'aide à la pose 5L		
	Article n°:	Box Label:	Info:	Dimensions	Qtty/Pack:	Unit Price:
	88106585	EASYPOSE5L	-	5 L	1	13,07
	OMSCHRIJVING			DESCRIPTION		
	Milde ontvetter 5 Liter			Dégraissant doux 5 Litres		
	Article n°:	Box Label:	Info:	Dimensions	Qtty/Pack:	Unit Price:
	2025781	HEXISO5L	-	5 L	1	39,41
	OMSCHRIJVING			DESCRIPTION		
	Geoncentreerde blauwe carshampoo			Shampooing concentré bleu pour carrosserie		
	Article n°:	Box Label:	Info:	Dimensions	Qtty/Pack:	Unit Price:
	88169937	SHAMPCAR	-	500 ml	1	13,13
	OMSCHRIJVING			DESCRIPTION		
	Schoonmaakmiddel voor matte PVC			Nettoyant et protecteur pour PVC mat		
	Article n°:	Box Label:	Info:	Dimensions	Qtty/Pack:	Unit Price:
	88169938	MATCLEAN	🕒	500 ml	1	12,21
	OMSCHRIJVING			DESCRIPTION		
	Schoonmaakmiddel voor velgen			Nettoyant pour jantes		
	Article n°:	Box Label:	Info:	Dimensions	Qtty/Pack:	Unit Price:
	88169939	NETJANTE	🕒	500 ml	1	12,98
	OMSCHRIJVING			DESCRIPTION		
	Ecologisch schoonmaakmiddel anti-graffiti 5L			Liquide de nettoyage antigraffiti écologique 5L		
	Article n°:	Box Label:	Info:	Dimensions	Qtty/Pack:	Unit Price:
	2025655	HEXAG	🕒	5 L	1	59,04
	OMSCHRIJVING			DESCRIPTION		
	Gel voor eenvoudige applicatie transparante films 1L			Gel pose facile film transp 1L		
	Article n°:	Box Label:	Info:	Dimensions	Qtty/Pack:	Unit Price:
	88162268	HEXISGEL1L	-	1 L	1	10,53
	OMSCHRIJVING			DESCRIPTION		
	Gel voor eenvoudige applicatie transparante films 5L			Gel pose facile film transp 5L		
	Article n°:	Box Label:	Info:	Dimensions	Qtty/Pack:	Unit Price:
	88162878	HEXISGEL 5L	-	5 L	1	42,13

# LIQUIDS LIQUIDES







OMSCHRIJVING			DESCRIPTION		
Applicatievloeistof voor eenvoudige applicatie vinyl			Liquide pose facile de vinyle 0,5L		
Article n°:	Box Label:	Info:	Dimensions	Qty/Pack:	Unit Price:
88169944	MAGICSPRAY	-		1	8,33

# WIPING

Reiniging : poetsdoeken en dispensers

Nettoyage : chiffons et distributeurs

PAPIER - PAPIER





	OMSCHRIJVING			DESCRIPTION		
	<p>Tork Industrial Heavy-Duty Wiping Paper Roll Blue. Volumineuze en super absorberende, 3 laagse, blauwe poetsdoek.</p> <ul style="list-style-type: none"> <li>• Neemt moeiteloos die, smeer en vek op sterk, zowel nat als droog. Extra sterk en absorberend dankzij QuickDry</li> <li>• Efficiënte verwijdering van olie</li> <li>• Goede natsterkte</li> <li>• Bescherming van de handen tegen hitte/metaal</li> <li>• Goedgekeurd voor gebruik met voedingsmiddelen</li> </ul>			<p>Tork Industrial Heavy-Duty Wiping Paper. Notre papier le plus résistant est doté d'un pouvoir d'absorption supérieur et protège les mains de la chaleur et de la saleté. Grâce à la qualité QuickDry le papier est plus résistant, plus absorbant que le papier ordinaire. Il vous fait gagner du temps.</p> <ul style="list-style-type: none"> <li>• Extra-résistant/absorbent grâce à sa qualité QuickDry</li> <li>• Idéal pour essuyer l'huile efficacement</li> <li>• Résistant même mouillé</li> <li>• Protège les mains de la chaleur et des éclats de metal</li> <li>• Certifié contact alimentaire</li> </ul>		
	Article n°:	Box Label:	Info:	Dimensions	Qtty/Pack:	Unit Price:
522185	130080	750 cps	37 cm x 255 m	1	68,33	
	OMSCHRIJVING			DESCRIPTION		
	<p>Tork Wiping Paper Plus Centerfeed Roll Blue. Het multifunctionele Tork Paper Plus Poetspapier bestaat uit 2 lagen en is ideaal om vloeistoffen mee op te nemen. Het papier is geschikt voor de Tork® Centerfeed Dispenser, een veelzijdige oplossing met hoge capaciteit voor een professionele omgeving waar diverse taken plaats vinden.</p> <ul style="list-style-type: none"> <li>• Zacht, sterk en absorberend papier, voor efficiënter drogen met minder verbruik.</li> <li>• Te bedienen met één hand, dus makkelijk in gebruik</li> <li>• Onbelemmerde verdeling zodat gebruikers zoveel kunnen nemen als hun taak vergt.</li> </ul>			<p>Tork Wiping Paper Plus Centerfeed Roll Blue. Le papier d'essuyage Plus Tork est idéal pour absorber les liquides et s'essuyer les mains. Ce papier peut s'utiliser avec le Distributeur mini à dévidage central Tork®, idéal pour les environnements professionnels présentant des besoins d'essuyage des mains et des surfaces.</p> <ul style="list-style-type: none"> <li>• Multi-Usages - Il satisfait à presque toutes les tâches de nettoyage</li> <li>• Ideal pour éponger</li> <li>• Adapté à l'essuyage des mains</li> <li>• Certifié contact alimentaire</li> </ul>		
	Article n°:	Box Label:	Info:	Dimensions	Qtty/Pack:	Unit Price:
515207	128207	450 cps	20cm x 157 m	6	56,91	
	OMSCHRIJVING			DESCRIPTION		
	<p>Tork Wiping Paper Plus Combi Roll. Het multifunctionele Tork Wiping Plus Poetspapier bestaat uit 2 lagen en is ideaal om vloeistoffen mee op te nemen of de handen te drogen. Het papier kan worden gebruikt in zowel Tork vloer- als wanddispensers, ontwikkeld voor veiligheid, efficiëntie en betrouwbaarheid. Ook is het geschikt voor de Tork Maxi Centerfeed Dispenser, ontworpen voor soepel gebruik met één hand.</p> <ul style="list-style-type: none"> <li>• De rol met hoge capaciteit gaat langer mee en bespaart tijd doordat er minder bijgevuld hoeft te worden</li> <li>• Goede absorptie om vloeistoffen op te nemen</li> <li>• QuickDry™ is ons sterkste, meest absorberende papier, voor efficiënter drogen met minder verspilling.</li> </ul>			<p>Tork Wiping Paper Plus Combi Roll. Le papier d'essuyage Plus Tork est idéal pour absorber les liquides et s'essuyer les mains. Ce papier peut s'utiliser avec les distributeurs Tork Dérouleur sur pied ou Tork Dérouleur mural, développés pour offrir sécurité, efficacité et fiabilité, ou avec le Distributeur Tork Maxi à Dévidage Central, conçu pour une distribution à une main facilitée.</p> <ul style="list-style-type: none"> <li>• Le rouleau de grande capacité dure plus longtemps et permet de réduire la maintenance</li> <li>• Bonne absorption pour éponger les liquides renversés</li> <li>• QuickDry™, notre papier le plus résistant et le plus absorbant, pour un séchage plus efficace et moins de gaspillage.</li> </ul>		
	Article n°:	Box Label:	Info:	Dimensions	Qtty/Pack:	Unit Price:
522184	130052	750 cps	24 cm x 255 m	2	31,24	
	OMSCHRIJVING			DESCRIPTION		
	<p>YelloWpipe Air (rol). Papier 2x meer absorberend dan gewoon papier - Zeer scheurbestendig - Bespaart reinigende vloeistoffen.</p>			<p>YelloWpipe Air (rouleau). Papier 2x plus absorbant que du papier ordinaire - Très résistant à la déchirure - Permet d'économiser les liquides de nettoyage.</p>		
	Article n°:	Box Label:	Info:	Dimensions	Qtty/Pack:	Unit Price:
88309885	YT09YCWP1	New	23.5cm x 38cm - 1000 toweletts	1	24,9	

# WIPING

Reiniging : poetsdoeken en dispensers

Nettoyage : chiffons et distributeurs

NON WOVENS - Non-Tissés.

	OMSCHRIJVING			DESCRIPTION		
	<p>Tork Heavy-Duty Cleaning Cloth Combi Roll in Box. De multifunctionele Tork Heavy-Duty Reinigingsdoek is zeer absorberend, dik en gaat zeer lang mee, en doorstaat hard schrobben zonder uit elkaar te vallen. Hij kan worden gebruikt met de meeste oplosmiddelen, en verwijdert olie, vet, water en hardnekkige plekken snel en effectief, terwijl hij de handen beschermt tegen hitte en metaalsplinters. Deze doek kan worden gebruikt in de vloer- en wanddispensers die ontwikkeld zijn voor veiligheid en efficiëntie. Ook is hij geschikt voor de Tork Maxi Centerfeed of Boxed Combirol Dispenser, ontworpen voor soepel gebruik met één hand. W1/W2</p>			<p>Tork Heavy-Duty Cleaning Cloth. Le chiffon de nettoyage ultra-résistant Tork est très absorbant, épais et durable. Il résiste aux tâches de nettoyage les plus difficiles sans tomber en lambeaux. Il peut être utilisé avec la plupart des solvants et élimine l'huile, la graisse, l'eau et les taches les plus tenaces rapidement et efficacement, tout en protégeant les mains de la chaleur et des éclats de métal. Ce chiffon est adapté aux distributeurs Tork dérouleur sur pied ou Tork dérouleur mural, développés pour offrir sécurité et efficacité, et au Distributeur Tork Maxi à Dévidage Central ou au Distributeur de chiffons W3 Tork, conçus pour une distribution à une main.</p>		
	Article n°:	Box Label:	Info:	Dimensions	Qtty/Pack:	Unit Price:
522105	530237	280 cps	32 cm x 106m.	1	57,26	
	OMSCHRIJVING			DESCRIPTION		
	<p>Tork Industrial Cleaning Cloth Handy Box. De Tork Reinigingsdoek Industrieel is een perfect alternatief voor lompem of huurdoeken. Door de zachtheid en flexibiliteit kunnen ook krappe ruimtes of fijne onderdelen worden gereinigd zonder het oppervlak te krassen. En toch is hij sterk genoeg om olie, vet en vuil op te vegen, en is hij geschikt voor de meeste oplosmiddelen. Het product wordt geleverd in een beschermende, verplaatsbare Handy-Box, waardoor de reinigingsdoek eenvoudig beschikbaar is wanneer u hem nodig hebt.</p>			<p>Tork Industrial Cleaning Cloth Handy Box. Le chiffon de nettoyage industriel Tork constitue une excellente alternative aux chiffons de location. Sa douceur et sa souplesse permettent de l'utiliser dans les petits espaces et sur les composants délicats sans en érafler la surface, mais il est suffisamment résistant pour éponger l'huile, la graisse et les saletés, et s'utilise avec la plupart des solvants. Ce produit est fourni dans une Handy-Box, solution portable et donc toujours à portée de main lorsque nécessaire.</p>		
	Article n°:	Box Label:	Info:	Dimensions	Qtty/Pack:	Unit Price:
522371	520371	280 cps	43 cm x 39 cm	1	48,3	
	OMSCHRIJVING			DESCRIPTION		
	<p>Tork Industrial Cleaning Cloth Roll. De Tork Reinigingsdoek Industrieel is een perfect alternatief voor lompem of huurdoeken. Door de zachtheid en flexibiliteit kunnen ook krappe ruimtes of fijne onderdelen worden gereinigd zonder het oppervlak te krassen. En toch is hij sterk genoeg om olie, vet en vuil op te vegen, en is hij geschikt voor de meeste oplosmiddelen. Hij kan worden gebruikt in de vloer- en wanddispensers die ontwikkeld zijn voor veiligheid, efficiëntie en betrouwbaarheid. W1</p>			<p>Tork Industrial Cleaning Cloth Roll. Le chiffon de nettoyage industriel Tork constitue une excellente alternative aux chiffons de location. Sa douceur et sa souplesse permettent de l'utiliser dans les petits espaces et sur les composants délicats sans en érafler la surface, mais il est suffisamment résistant pour éponger l'huile, la graisse et les saletés, et s'utilise avec la plupart des solvants. Il est adapté aux distributeurs Tork dérouleur sur pied ou Tork dérouleur mural, développés pour offrir sécurité, efficacité et fiabilité.</p>		
	Article n°:	Box Label:	Info:	Dimensions	Qtty/Pack:	Unit Price:
522304	520304	🕒 - 950 cps	43 cm x 38 cm	1	163,8	
	OMSCHRIJVING			DESCRIPTION		
	<p>Tork Reinigingsrol Prem 510 wit. De multifunctionele Tork Reinigingsdoek is zacht en flexibel, maar toch sterk. Hij is ideaal voor de meeste lichtere reinigingsstaken en absorbeert zowel olie als vloeistoffen snel, waardoor uw inspanningen sneller worden beloond. De doek kan worden gebruikt in zowel vloer- als wanddispensers die ontwikkeld zijn voor veiligheid, efficiëntie en betrouwbaarheid. Ook is de doek geschikt voor de Tork Maxi Centerfeed of Boxed Combirol Dispenser, ontworpen voor soepel gebruik met één hand. W1/W2</p>			<p>Tork Chif Premium 510 Roll blanc Le chiffon de nettoyage multi-usages Tork est à la fois doux, souple et résistant. Il est idéal pour la plupart des tâches de nettoyage légères, et absorbe rapidement les huiles et les liquides, simplifiant le travail de nettoyage. Ce chiffon peut s'utiliser avec les distributeurs Tork dérouleur sur pied ou Tork dérouleur mural, développés pour offrir sécurité, efficacité et fiabilité, ou avec le Distributeur Tork Maxi à Dévidage Central ou le Distributeur de chiffons Tork W1/2/3, conçus pour une distribution à une main facilitée.</p>		
	Article n°:	Box Label:	Info:	Dimensions	Qtty/Pack:	Unit Price:
522510	510137	400 cps	32 cm x 152 m.	1	45,97	

# WIPING





Reiniging : poetsdoeken en dispensers

Nettoyage : chiffons et distributeurs

NON WOVENS - Non-Tissés.



	OMSCHRIJVING	DESCRIPTION				
	<p>Optimal Polytex(zeemveleffect). polytex Door zijn pluïsvrije en volumineuze karakter is deze doek uitermate geschikt voor het reinigen en ontvetten van carrosserieën en drukpersen. Deze doek bestaat uit polypropoleen en is verkrijgbaar in verschillende grammages. Verder kan dit product gebruikt worden binnen de zware industrie, voedingssector, luchtvaartindustrie... Het grote voordeel van polytex is zijn structuur die de doek een groot volume geeft waardoor deze doek heel goed in de hand ligt. Verder is deze doek oplosmiddelbestendig, sterk, zacht, pluïsvrij en heeft hij een groot absorberend vermogen. .</p>	<p>Optimal Polytex (effet peau de chamois). En raison de sa nature volumineuse et sa texture non pelucheuse, ce chiffon convient parfaitement pour le nettoyage et le dégraissage. Ce tissu est constitué de polypropylène. Le grand avantage du Polytex est sa structure qui donne au tissu un grand volume. En plus, ce tissu est résistant aux solvants, il est doux et non pelucheux, et dispose d' une grande capacité d'absorption. .</p>				
	Article n°:	Box Label:	Info:	Dimensions	Qty/Pack:	Unit Price:
	569169	7164	500 cps	32 cm x 38 cm.	1	63,54

## DISPENSERS PAPER AND NON WOVENS

	OMSCHRIJVING			DESCRIPTION		
	Afwikkelaar met grote capaciteit. Compatibel met Tork W1 en W2. Kan eenvoudig verplaatst worden verplaatst rond de werkplek.			Dérouteur sur pied pour rouleaux de grande capacité. Compatible avec les tissus et papier Tork W1 et W2. Il est autonome et peut être facilement déplacé autour du lieu de travail.		
	Article n°:	Box Label:	Info:	Dimensions	Qty/Pack:	Unit Price:
	2013577	652000	-	101 x 65x 53 cm	1	90,25
	OMSCHRIJVING			DESCRIPTION		
	Wandafwikelaar Wit / Turquoise met grote capaciteit. Compatibel met W1 en W2 Tork tissue en papier, eenvoudig en snel te herladen.			Dérouteur mural Blanc/Turquoise pour rouleaux de grande capacité. Compatible avec Tork W1 et W2 tissus et papiers, il est facile et rapide à recharger.		
	Article n°:	Box Label:	Info:	Dimensions	Qty/Pack:	Unit Price:
	2013581	652100	-	47 x 65 x 28 cm	1	60,98
	OMSCHRIJVING			DESCRIPTION		
	Dispenser Wit / Turquoise, hoge capaciteit, open center feed. Compatibel met Tork W2			Distributeur Blanc/Turquoise, haute capacité, à dévidage central libre. La conception du distributeur offre un niveau élevé de durabilité et de fonctionnalité. Compatible avec Tork W2		
	Article n°:	Box Label:	Info:	Dimensions	Qty/Pack:	Unit Price:
	2013583	653000	-	45 x 33 x 31 cm	1	60,98
	OMSCHRIJVING			DESCRIPTION		
	MTork Centerfeed (M2) white. Compatibel met Tork M2			Distributeur pour Bobine à dévidage central (M2) - Blanc. Compatible avec Tork M2		
	Article n°:	Box Label:	Info:	Dimensions	Qty/Pack:	Unit Price:
	2001065	559000	-	36 x 24 x 23 cm	1	48,98

## DOUBLE SIDED TAPES

Dubbelzijdige tapes  
Tapes double-face





	OMSCHRIJVING			DESCRIPTION		
	3M Scotch 4032 PU foam 0,8mm			3M Scotch 4032 PU foam 0,8mm		
	Article n°:	Box Label:	Info:	Dimensions	Qty/Pack:	Unit Price:
	890642	Scotch 4032	-	19 mm x 66 m	1	51,11
	OMSCHRIJVING			DESCRIPTION		
	3M 9546 VHB PE Outdoor - Acryl foam 1,0mm			3M 9546 VHB PE Outdoor - Acryl foam 1,0mm		
	Article n°:	Box Label:	Info:	Dimensions	Qty/Pack:	Unit Price:
	890646	3M 9546	-	19 mm x 66 m	1	30,7



# PROTECTION PACKAGING SHIPPING PROTECTION EMBALLAGE EXPEDITION

Bescherming, verpakking en verzending.  
Protection, emballage et expédition.





## LUCHTKUSSENFOLIE - FILM A BULLES

	OMSCHRIJVING			DESCRIPTION		
	Breedte 50 cm			Largeur 50 cm		
	Article n°:	Box Label:	Info:	Dimensions	Qty/Pack:	Unit Price:
	2037017	-	-	50 cm x100 m	1	31,5
	OMSCHRIJVING			DESCRIPTION		
	Breedte 100 cm			Largeur 100 cm		
	Article n°:	Box Label:	Info:	Dimensions	Qty/Pack:	Unit Price:
	2037019	-	-	100 cm x100 m	1	60,9
	OMSCHRIJVING			DESCRIPTION		
	Breedte 120 cm			Largeur 120 cm		
	Article n°:	Box Label:	Info:	Dimensions	Qty/Pack:	Unit Price:
	2037018	-	-	120 cm x100 m	1	73,5
	OMSCHRIJVING			DESCRIPTION		
	Breedte 150 cm			Largeur 150 cm		
	Article n°:	Box Label:	Info:	Dimensions	Qty/Pack:	Unit Price:
	2037020	-	-	150 cm x100 m	1	91,35

## KLEEFBANDEN - RUBANS ADHESIFS

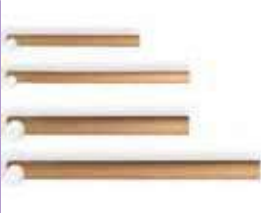
	OMSCHRIJVING			DESCRIPTION		
	PP Tape Low Noise Bruin			Tape PP Faible Bruit Brun		
	Article n°:	Box Label:	Info:	Dimensions	Qty/Pack:	Unit Price:
	88026272			50 mm x 66 m	36	1,84
	OMSCHRIJVING			DESCRIPTION		
	PP Tape Low Noise Transparent			Tape PP Faible Bruit Transparent		
	Article n°:	Box Label:	Info:	Dimensions	Qty/Pack:	Unit Price:
	88026277			50 mm x 66 m	36	1,84
	OMSCHRIJVING			DESCRIPTION		
	Dispenser voor plakpapier(50 mm.) Met rem.			Dévidoir pour papier collant(50 mm.) avec frein.		
	Article n°:	Box Label:	Info:	Dimensions	Qty/Pack:	Unit Price:
	2014352				1	14,4

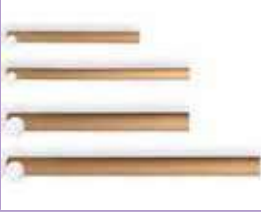
## VERZENDKOKERS - MANDRINS D'EXPEDITION

	OMSCHRIJVING			DESCRIPTION		
	Breedte 54 cm			Largeur 54 cm		
	Article n°:	Box Label:	Info:	Dimensions	Qtty/Pack:	Unit Price:
	540020	-	-	Ø 50 mm	50	37,54
	OMSCHRIJVING			DESCRIPTION		
	Breedte 74 cm			Largeur 74 cm		
	Article n°:	Box Label:	Info:	Dimensions	Qtty/Pack:	Unit Price:
	540021	-	-	Ø 50 mm	50	48,56
	OMSCHRIJVING			DESCRIPTION		
	Breedte 74 cm			Largeur 74 cm		
	Article n°:	Box Label:	Info:	Dimensions	Qtty/Pack:	Unit Price:
	540023	-	-	Ø 80 mm	25	43,58
	OMSCHRIJVING			DESCRIPTION		
	Breedte 104 cm			Largeur 104 cm		
	Article n°:	Box Label:	Info:	Dimensions	Qtty/Pack:	Unit Price:
	540024	-	-	Ø 80 mm	25	53,81
PAPYRUS 	OMSCHRIJVING			DESCRIPTION		
	Witte plastic dop*			Bouchon blanc en plastique*		
	Article n°:	Box Label:	Info:	Dimensions	Qtty/Pack:	Unit Price:
	540030	-	-	Ø 50 mm	100	13,13
PAPYRUS 	OMSCHRIJVING			DESCRIPTION		
	Witte plastic dop*			Bouchon blanc en plastique*		
	Article n°:	Box Label:	Info:	Dimensions	Qtty/Pack:	Unit Price:
	540031	-	-	Ø 80 mm	50	15,49

\*worden enkel samen met verzendkokers geleverd - \*sont livrés uniquement avec les mandrins d'expédition



# Papyrus Viscom

Prijslijst / Liste de prix  
Display Systems



**PAPYRUS** 

Your partner in Visual Communication



# Display Systems



DISPLAY ROLL-UP.....	221
ROLL X CHANGE . . . . .	.221
ROLL STYLE . . . . .	.221
EASY LIGHT . . . . .	.221
EASY MAX . . . . .	.222
EASY LUX SILVER . . . . .	.222
EASY LUX Black . . . . .	.222
EASY TELESCOPIC . . . . .	.223
EASY OVAL . . . . .	.223
ROLL SOLID . . . . .	.223
ROLL SOLID PLUS . . . . .	.224
EASY ROLL PLUS . . . . .	.224
LUX DOUBLE . . . . .	.224
EASY CHROME . . . . .	.225
CHANGE DOUBLE . . . . .	.225
EASY CHANGE . . . . .	.225
ROLL DOUBLE . . . . .	.226
XXL ROLLUP . . . . .	.226
ROLLUP MINI . . . . .	.226
ROLL UP Lights . . . . .	.227



## DISPLAY ROLL-UP

Texte NL

Texte FR

Description	 cm.	 cm.	Supplier Ref.	Papyrus Ref.	Info	€
-------------	---	---	---------------	--------------	------	---

### ROLL X CHANGE

Clip bar - verwijderbare cartridge - Telescopische Mast - Gevoerde Draagtas - Individueel verpakt  
 Rail supérieur clipant - cartouches interchangeable - Mât télescopique - Sac rembourré - Carton individuel

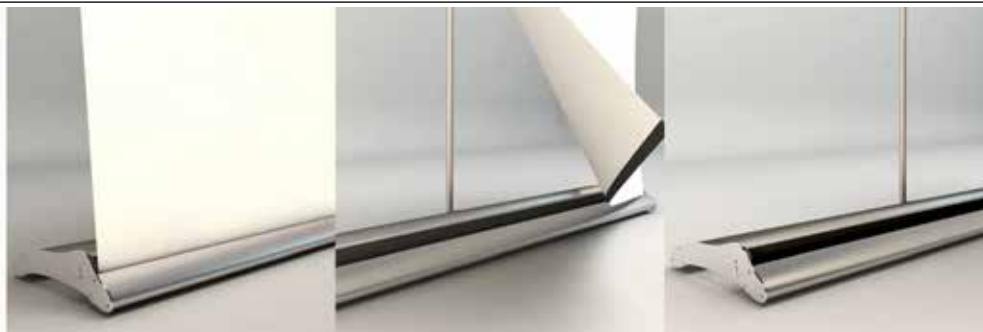

ROLL X Change 85 x 220	85	162 - 220	1311	88104594		52,55
ROLL X Change 100 x 220	100	162 - 220	1311	88104595		65,27

### ROLL STYLE

Clip bar - Telescopische Mast - Gevoerde Draagtas - Individueel verpakt  
 Pieds avec fixations - Mât télescopique - Sac rembourré - Carton individuel





ROLL X Style 85 x 220	85	160 - 220	1411			41,64
ROLL X Style 100 x 220	100	160 - 220	1412			52,55







### EASY LIGHT

Clip bar - 3-delige paal - Canvas Draagtas +Individueel verpakt in karton doos  
 Pieds avec fixations - Mât 3 pièces - Sac en toile + Carton individuel



Easy Light 60 x 200	60	200	1000	88134911		16,18
Easy Light 80 x 200	80	200	1001	88134914		17,64
Easy Light 85 x 200	85	200	1002	88104592		17,82
Easy Light 100 x 200	100	200	1003	88104593		21,64
Easy Light 120 x 200	120	200	1004	88134916		28,91

## DISPLAY ROLL-UP (Vervolg - Suite)

Description	 cm.	 cm.	Supplier Ref.	Papyrus Ref.	Info	€
<b>EASY MAX</b>						
Telescopische Mast - Indivueel verpakt - Gevoerde Draagtas Mât Télescopique - Sac Rembourré - Carton individuel						
						
Easy Max 60 x 220	60	160 - 220	ou 230	1500	88135035	 80,15
Easy Max 85 x 220	85	160 - 220	ou 230	1501	88135036	87,60
Easy Max 100 x 220	100	160 - 220	ou 230	1502	88135039	111,56
Easy Max 120 x 220	120	160 - 220	ou 230	1503	88135089	135,15





## EASY LUX SILVER

Clip bar - Telescopische Mast - Indivueel verpakt - Gevoerde Draagtas  
Mât télescopique - Sac Rembourré - Carton individuel



						
Easy Lux Silver 85 x 220	85	160 - 220	1200	88134946		72,55
Easy Lux Silver 100 x 220	100	160 - 220	1201			90,73

## EASY LUX Black

Clip bar - 3-delige Mast  
Mât 3 pièces - Sac Rembourré - Carton individuel

						
Easy Lux Black 85 x 220	85	160 - 220	1202	88134963		81,85

## DISPLAY ROLL-UP (Vervolg - Suite)

Description	 cm.	 cm.	Supplier Ref.	Papyrus Ref.	Info	€
-------------	---	---	---------------	--------------	------	---

### EASY TELESCOPIC

Clip bar - Telescopische Mast - Gevoerde Draagtas - Individueel verpakt  
 Pieds avec fixations - Mât télescopique - Sac rembourré - Carton individuel



Easy Telescopic 85 x 220	85	160 - 220	1801			38,27
Easy Telescopic 100 x 220	100	160 - 220	1802			50,73
Easy Telescopic 120 x 220	120	160 - 220	1803			58,00
Easy Telescopic 150 x 220	150	160 - 220	1804			70,73

### EASY OVAL

Clip bar - 3-delige Mast - Gevoerde Draagtas - Individueel verpakt  
 Pieds avec fixations - Mât 3 pièces - Sac Rembourré - Carton individuel



Easy Oval 85 x 200	85	200	1010B			22,73
--------------------	----	-----	-------	--	--	-------

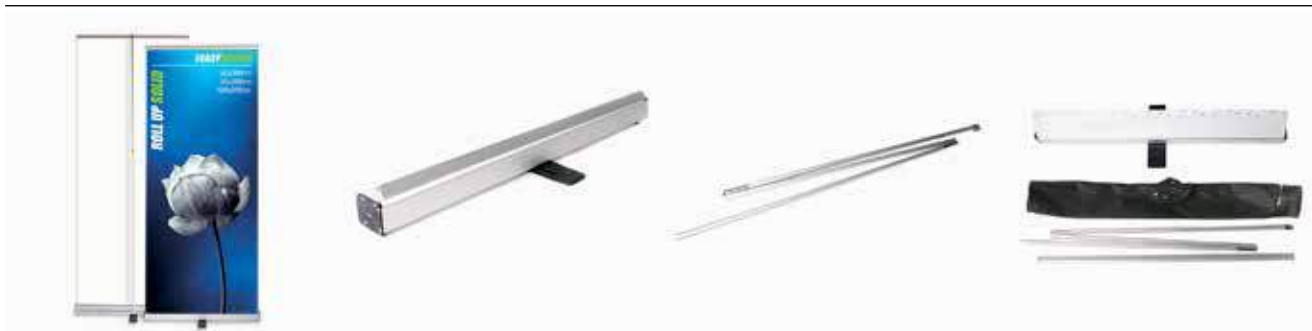

### ROLL SOLID

Driedelige mast en versterkte masthouder - Standaard draagtas in stof  
 Enrouleur élégant, ligne compacte - Pied avec fixations - Mât en trois parties et renfort pour mât dans la base - Sac non-rembourré standard en tissu



Easy Oval 60 x 200	60	200				11,82
Easy Oval 80 x 200	80	200	1031			13,64
Easy Oval 85 x 200	85	200	1032			14,18
Easy Oval 100 x 200	100	200	1033			16,73

## DISPLAY ROLL-UP (Vervolg - Suite)

Description	 cm.	 cm.	Supplier Ref.	Papyrus Ref.	Info	€
-------------	---	---	---------------	--------------	------	---

### ROLL SOLID PLUS

Driedelige mast en versterkte masthouder - Versterkte draagtas met een ritssluiting over heel de lengte - Individueel verpakt in karton doos

Mât en trois parties et renfort pour mât dans la base - Pied avec fixations - Sac rembourré avec fermeture éclair sur sa toute sa longueur - Carton individuel



Roll Solid Plus 85 x 200	85	200	1121			19,82
Roll Solid Plus 100 x 200	100	200	1122			25,27

### EASY ROLL PLUS

Clip bar - 3-delige Mast - Individueel verpakt - Gevoerde Draagtas  
Pieds avec fixations - Mât 3 pièces - Sac Rembourré - Carton individuel

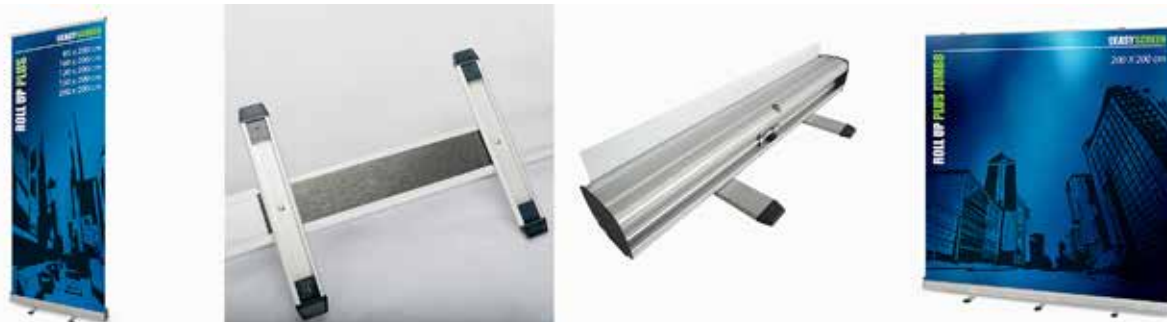

Easy Roll Plus 85 x 207	85	207	1111	88134923		22,36
Easy Roll Plus 100 x 207	100	207	1112	88134941		28,91
Easy Roll Plus 120 x 207	120	207	1113	88134943		40,73
Easy Roll Plus 150 x 207	150	207	1114			50,73
Easy Roll Plus 8200 x 207	200	207	1115			88,91

### LUX DOUBLE



3-delige Mast - Clip bar - Gevoerde Draagtas  
Mât 3 pièces - Sac Rembourré



Lux Double 85 x 200	85	200	1104			52,55
Lux Double 100 x 200	100	200	1105			61,64







## DISPLAY ROLL-UP (Vervolg - Suite)

Description	 cm.	 cm.	Supplier Ref.	Papyrus Ref.	Info	€
-------------	---	---	---------------	--------------	------	---





### EASY CHROME

3-delige Mast - Individueel verpakt - Gevoerde Draagtas  
 Pieds avec fixations - Mât 3 pièces - Sac Rembourré - Carton individuel

							
Easy Chrome 60 x 212	60	212	1400	88134971		34,55	
Easy Chrome 85 x 212	85	212	1401	88104590		40,44	
Easy Chrome 100 x 212	100	212	1402	88104591		49,78	
Easy Chrome 120 x 212	120	212	1403	88135005		63,48	
Easy Chrome 150 x 212	150	212	1404	88135034		77,02	







### CHANGE DOUBLE

Clip bar - 3-delige paal - Individueel verpakt - Gevoerde Draagtas  
 Mât 3 pièces - Sac Rembourré - Carton individuel

							
Change Double 85 x 220	85	220	1305	88134970		67,09	

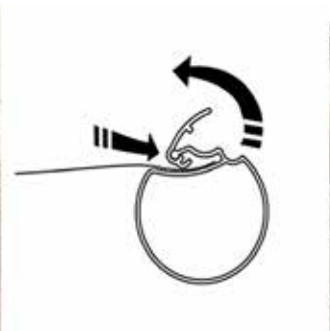
### EASY CHANGE

3-delige Mast - Gevoerde Draagtas - Individueel verpakt  
 Mât 3 pièces - Sac Rembourré - Carton individuel



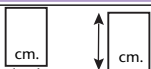

							
Easy Change 60 x 220	60	220	1300	88134965		48,91	
Easy Change 85 x 220	85	220	1301	88104594		50,73	
Easy Change 100 x 220	100	220	1302	88104595		63,45	
Easy Change 120 x 220	120	220	1303	88134968		72,55	
Easy Change 150 x 220	150	220	1304	88134969		94,36	

## DISPLAY ROLL-UP (Vervolg - Suite)

Description		Supplier Ref.	Papyrus Ref.	Info	€
-------------	---	---------------	--------------	------	---

### ROLL DOUBLE





Clip bar - 3-delige Mast - Canvas Draagtas - Pieds avec fixation - Mât 3 pièces - Sac en toile

					
Roll Double 85 x 200	85	200	1103	88134945	52,55

### XXL ROLLUP



Clip Stang met schroef - 3-delige Mast - Individueel verpakt - Gevoerde Draagtas

Le Rollup 200 vous offre jusqu'à 6 mètres carré de superficie pour communiquer, pour une surface au sol extrêmement réduite. Son mât télescopique peut faire varier la hauteur de votre visuel, entre 1,70m et 3m. Enfin, son coffre en aluminium et ses deux pieds en acier vous garantissent un produit stable et résistant.



					
Xxl Rollup 200 x 170 - 300	200	170 - 300	1900		159,82

### ROLLUP MINI

Bovenrail met dubbelzijdig plakband - 2-delige Mast - Kartonverpakking - Rail dessus avec ruban adhésif - Mât 2 pièces - Valise en Carton

					
Rollup Mini A4	A4		1701		5,31
Rollup Mini A3	A3		1700		6,04
Rollup Mini Double	A3		1702		10,65

## DISPLAY ROLL-UP (Vervolg - Suite)

Description	 cm.	 cm.	Supplier Ref.	Papyrus Ref.	Info	€
-------------	---	---	---------------	--------------	------	---

### ROLL UP Lights

Lamp voor Roll Up  
Lampes pour Roll up



Roll UP Lights - Led  
Roll UP Lights - Spot



2901	88135633		54,36
2903	88135636		39,82



# Papyrus Viscom

Prijslijst / Liste de prix  
Screen Media



**PAPYRUS**   
Your partner in Visual Communication



# Screen Media

## Promotional Self Adhesive Screen Films - Films de sérigraphie adhésifs promotionels

White Vinyl Mactac - Vinyle Blanc Mactac . . . . .	.233
MACAL 8129 Gloss White - 100µ . . . . .	.233
MACAL 8129 Gloss White - 100µ . . . . .	.233
MACAL 8128 Matt White - 100µ . . . . .	.233
MACAL 8128 Matt White - 100µ . . . . .	.233
White Vinyl Avery - Vinyle Blanc Avery . . . . .	.234
Avery 400 Gloss White - 90µ . . . . .	.234
Avery 400 Gloss White - 90µ . . . . .	.234
Avery 400 Gloss White - 90µ . . . . .	.234
Avery 400 Gloss White - 90µ . . . . .	.234
Avery 400 Gloss White Coverall - 100µ . . . . .	.234
Avery 400 Gloss White Coverall - 100µ . . . . .	.234
Avery 420 Matt White - 80µ . . . . .	.234
Transparent Vinyl Mactac - Vinyle Transparent Mactac . . . . .	.235
MACAL 8199 Gloss Transparent - 100µ . . . . .	.235
MACAL 8199 Gloss Transparent - 100µ . . . . .	.235
Transparent Vinyl Avery - Vinyle Transparent Avery . . . . .	.236
Avery 440 Gloss Transparent - 90µ . . . . .	.236
Avery 440 Gloss Transparent - 90µ . . . . .	.236
Avery 440 Gloss Transparent - 90µ . . . . .	.236
Coloured Vinyl Mactac - Vinyles Colorés Mactac . . . . .	.237
MACAL 8101-04 Orange - 90µ . . . . .	.237
MACAL 8103-03 Gold Yellow - 90µ . . . . .	.237
MACAL 8105-02 Dark Yellow - 90µ . . . . .	.237
Macal 8109-01 Light Yellow - 90µ . . . . .	.237
Macal 8159-04 Red - 90µ . . . . .	.237
Macal 8189 Black - 90µ . . . . .	.237
Coloured Vinyl Avery - Vinyles Colorés Avery . . . . .	.238
Avery 400 Gloss Black - 80µ . . . . .	.238

## Durable Self Adhesive Screen Films

Durable Screen Films Mactac - Films Mactac Durables . . . . .	.239
MACAL 9829 Gloss White Polymeric Film - 80µ . . . . .	.239
Durable Screen Films Avery Sheets - Films Avery Durables . . . . .	.239
Avery 895 Screen Gloss White Polymeric - 100µ . . . . .	.239
Avery 900 Screen Gloss White Cast - 50µ . . . . .	.239
Durable Screen Films Avery Reels- Films Avery Durables En Rouleaux . . . . .	.239
Avery 895 Screen Gloss White Polymeric - 100µ . . . . .	.239
Avery 840 Screen Gloss Transparent Polymeric - 100µ . . . . .	.239
Avery 4900 QM Apolar Screen Gloss White Cast - 50µ . . . . .	.239

## Special Self Adhesive Screen Films

Polyester Screen Films Mactac - Films Polyester Mactac . . . . .	.240
MILMAR TC Gloss Clear Polyester Film - 25µ . . . . .	.240
MILMAR TC Bright Silver Polyester Film - 25µ . . . . .	.240
MILMAR TC Dull Silver Polyester Film - 25µ . . . . .	.240
PET/PVC Screen Films Mactac - Films PET/PVC Mactac . . . . .	.240
Aluminium Screen Films Mactac - Films Aluminium Mactac . . . . .	.240
Solid Matt Silver Aluminium Film - 40µ . . . . .	.240
Acetate Screen Films Mactac - Films Acétate Mactac . . . . .	.240
MACSILKY White Rayon Acetate Cloth - 130µ . . . . .	.240
Ultra Destructible Screen Films MacTac - Films Ultra Destructible MacTac . . . . .	.240
Ultra Destructible Film - 50µ . . . . .	.240

## Special Self Adhesive Screen Films

Thick MacTac PVC Films - Films Mactac Epais . . . . .	.241
Macal 8229 Gloss White Soft PVC Film - 200µ . . . . .	.241
Double sided films Mactac - Film Double Face Mactac . . . . .	.241
MacBond B1148 Thin Polyester Film - 12µ . . . . .	.241
Polyester Screen Films Avery - Films Polyester Avery . . . . .	.242
Avery 710 Chrome Polyester . . . . .	.242
Avery 711 Satin Chrome Polyester . . . . .	.242
Aluminium Screen Films Avery - Films Aluminium Avery . . . . .	.242
Avery 180 Solid Foil Matt Aluminium . . . . .	.242
Ultra Destructible Screen Films Avery - Films Ultra Destructible Avery . . . . .	.242
Avery 2920 QM Ultra Destructible Matt White Cast . . . . .	.242
Acetate Screen Films Avery - Films Acétate Avery . . . . .	.242
Avery Acetate Satin Cloth - 125µ . . . . .	.242
Avery Gum Twin- Offset Paper 70 gr./m2 - Papier Offset 70 gr./m2 autocollant Ddouble-Face . . . . .	.242
Avery Gum Twin . . . . .	.242







## Promotional Self Adhesive Screen Films Films de sérigraphie adhésifs promotionels

### White Vinyl Mactac - Vinyle Blanc Mactac

	forma(a)t cm	ref. Papyrus	info	Rug Dos	verpakking emballage	1 €/1000 vel/feuilles
<b>MACAL 8129 Gloss White - 100µ</b> Permanente lijm - Colle permanente						
100	70 x 100	88069619		-	per 100 sheets	1231,43
	70 x 100	88069621			per 100 sheets	1231,43
	70 x 100	88069631			pallet 2000 sheets	927,96
	70 x 100	88069632			pallet 2000 sheets	927,96
<b>MACAL 8129 Gloss White - 100µ</b> Verwijderbare lijm - Colle enlevable						
100	70 x 100	88069620		-	per 100 sheets	1231,43
	70 x 100	88070466		-	pallet 2000 sheets	918,25
<b>MACAL 8128 Matt White - 100µ</b> Permanente lijm - Colle permanente						
100	70 x 100	88070469		-	per 100 sheets	1309,17
	70 x 100	88070470			per 100 sheets	1309,17
<b>MACAL 8128 Matt White - 100µ</b> Verwijderbare lijm - Colle enlevable						
100	70 x 100	88070471		-	per 100 sheets	1309,17

snijkosten frais de découpe	€ 0,03/coupon - forfait € 2,50
rollen rouleaux	beschikbaar op aanvraag disponibles sur demande
toeslag supplément	65 % bij opening van riem 65 % en cas d'ouverture de rame

	ingeriemd per 100 vel/enramé par 100 feuilles
	pallet, niet ingeriemd: 2.000 vel palette, non-enramé: 2.000 feuilles
	Split Macline //100 cm Refente Macline //100 cm
	zonder opdruk op rugpapier sans impression au verso

levertijd 3 tot 4 werkdagen / délai de livraison : 3 à 4 jours ouvrables



## Promotional Self Adhesive Screen Films (Vervolg - Suite)

### White Vinyl Avery - Vinyle Blanc Avery

	forma(a)t cm	ref. Papyrus	info	Rug Dos	verpakking emballage	1 €/1000 vel/feuilles
--	-----------------	-----------------	------	------------	-------------------------	--------------------------

#### Avery 400 Gloss White - 90µ

Permanente lijm - Colle permanente

100	70 x 100	88102828			per 100 sheets	1296,58
	70 x 100	88153089			per 100 sheets	1141,38
	70 x 100	88105549			pallet 1500 sheets	992,10
	70 x 100	88153093			pallet 1500 sheets	992,10

#### Avery 400 Gloss White - 90µ

Verwijderbare lijm - Colle enlevable

90	70 x 100	88102829			per 100 sheets	1296,58
----	----------	----------	--	--	----------------	---------

#### Avery 400 Gloss White - 90µ

Ultra Verwijderbare lijm - Colle ultra enlevable

90	100 x 70	88165748			per 100 sheets	1663,19
----	----------	----------	--	--	----------------	---------

#### Avery 400 Gloss White - 90µ

"Super Tack" lijm - Colle "Super Tack"

90	70 x 100	88101065			per 100 sheets	1663,19
----	----------	----------	--	--	----------------	---------

#### Avery 400 Gloss White Coverall - 100µ

Permanente lijm - Colle permanente 100µ

100	70 x 100	88105554			per 100 sheets	1649,75
-----	----------	----------	--	--	----------------	---------

#### Avery 400 Gloss White Coverall - 100µ

Verwijderbare lijm - Colle enlevable

100	70 x 100	88136430			per 100 sheets	1649,75
-----	----------	----------	--	--	----------------	---------

#### Avery 420 Matt White - 80µ

Permanente lijm - Colle permanente

80	70 x 100	88101066			per 100 sheets	1246,47
----	----------	----------	--	--	----------------	---------

snijkosten frais de découpe	€ 0,03/coupon - forfait € 2,50
rollen rouleaux	beschikbaar op aanvraag disponibles sur demande
toeslag supplément	65 % bij opening van riem 65 % en cas d'ouverture de rame



	ingeriemd per 100 vel/enramé par 100 feuilles
	pallet, niet ingeriemd: 1.500 vel palette, non-enramé: 1.500 feuilles
	Score Back split //100 cm refente Score Back //100 cm
	zonder opdruk op rugpapier sans impression au verso

levertijd 3 tot 4 werkdagen / délai de livraison : 3 à 4 jours ouvrables



## Promotional Self Adhesive Screen Films (Vervolg - Suite)

### Transparant Vinyl Mactac - Vinyle Transparent Mactac

	forma(a)t cm	ref. Papyrus	info	Rug Dos	verpakking emballage	1  €/1000 vel/feuilles
---	-----------------	-----------------	------	------------	-------------------------	--

#### MACAL 8199 Gloss Transparant - 100µ

Permanente lijm - Colle permanente





100	70 x 100	88069634		-	per 100 sheets	1243,77
	70 x 100	88069636			per 100 sheets	1243,77
	70 x 100	88070473		-	pallet 2000 sheets	927,96
	70 x 100	88070474			pallet 2000 sheets	927,96

#### MACAL 8199 Gloss Transparant - 100µ

Verwijderbare lijm - Colle enlevable

100	70 x 100	88069635		-	per 100 sheets	1208,98
	70 x 100	88103680		-	pallet 2000 sheets	937,66

snijkosten frais de découpe	€ 0,03/coupon - forfait € 2,50
rollen rouleaux	beschikbaar op aanvraag disponibles sur demande
toeslag supplément	65 % bij opening van riem 65 % en cas d'ouverture de rame

	ingeriemd per 100 vel/enramé par 100 feuilles
	pallet, niet ingeriemd: 2.000 vel palette, non-enramé: 2.000 feuilles
	Split Macline //100 cm Refente Macline //100 cm
	zonder opdruk op rugpapier sans impression au verso

 levertijd 3 tot 4 werkdagen / délai de livraison : 3 à 4 jours ouvrables



## Promotional Self Adhesive Screen Films (Vervolg - Suite)

### Transparant Vinyl Avery - Vinyle Transparent Avery

	forma(a)t cm	ref. Papyrus	info	Rug Dos	verpakking emballage	1 €/1000 vel/feuilles
--	-----------------	-----------------	------	------------	-------------------------	--------------------------

#### Avery 440 Gloss Transparant - 90µ

Permanente lijm - Colle permanente

90	70 x 100	88105557			per 100 sheets	1296,58
	70 x 100	88153094			per 100 sheets	1226,92
	100 x 140	#			pallet 1500 sheets	1984,19

#### Avery 440 Gloss Transparant - 90µ

Verwijderbare lijm - Colle enlevable

90	70 x 100	88105558			per 100 sheets	1296,58
	70 x 100	#			pallet 1500 sheets	992,10
	100 x 140	#			pallet 3000 sheets	1984,19

#### Avery 440 Gloss Transparant - 90µ

Ultra Verwijderbare lijm - Colle Ultra enlevable

90	100 x 70	88165750			per 100 sheets	1663,19
----	----------	----------	--	--	----------------	---------

snijkosten frais de découpe	€ 0,03/coupon - forfait € 2,50
rollen rouleaux	beschikbaar op aanvraag disponibles sur demande
toeslag supplément	65 % bij opening van riem 65 % en cas d'ouverture de rame



	ingeriemd per 100 vel/enramé par 100 feuilles
	pallet, niet ingeriemd: 2.000 vel palette, non-enramé: 2.000 feuilles
	Split Macline //100 cm Refente Macline //100 cm
	zonder opdruk op rugpapier sans impression au verso

levertijd 3 tot 4 werkdagen / délai de livraison : 3 à 4 jours ouvrables



## Promotional Self Adhesive Screen Films (Vervolg - Suite)

### Coloured Vinyl Mactac - Vinyles Colorés Mactac

	forma(a)t cm	ref. Papyrus	info	Rug Dos	verpakking emballage	1  €/1000 vel/feuilles
<b>MACAL 8101-04 Orange - 90µ</b> Permanente lijm - Colle permanente						
90	70 x 100	88146785		-	per 100 sheets	2086,52
<b>MACAL 8103-03 Gold Yellow - 90µ</b> Permanente lijm - Colle permanente						
90	70 x 100	88146786		-	per 100 sheets	2086,52
<b>MACAL 8105-02 Dark Yellow - 90µ</b> Permanente lijm - Colle permanente						
90	70 x 100	88146788		-	per 100 sheets	2086,52
<b>Macal 8109-01 Light Yellow - 90µ</b> Permanente lijm - Colle permanente						
90	70 x 100	88146789		-	per 100 sheets	2086,52
<b>Macal 8139-04 Blue - 90µ</b> Permanente lijm - Colle permanente						
90	70 x 100	88146790		-	per 100 sheets	2086,52
<b>Macal 8149-02 Green - 90µ</b> Permanente lijm - Colle permanente						
90	70 x 100	88146793		-	per 100 sheets	2086,52
<b>Macal 8159-04 Red - 90µ</b> Permanente lijm - colle permanente						
90	70 x 100	88146794		-	per 100 sheets	2086,52
<b>Macal 8189 Black - 90µ</b> Permanente lijm - Colle permanente						
90	70 x 100	88146795		-	per 100 sheets	2086,52



## Promotional Self Adhesive Screen Films (Vervolg - Suite)

### Coloured Vinyl Avery - Vinyles Colorés Avery

	forma(a)t cm	ref. Papyrus	info	Rug Dos	verpakking emballage	1 €/1000 vel/feuilles
--	-----------------	-----------------	------	------------	-------------------------	--------------------------

**Avery 400 Gloss Black - 80µ**

Permanente lijm - Colle permanente

80	70 x 100	88105562			per 100 sheets	1649,75
----	----------	----------	--	--	----------------	---------

**Avery 400 Matt Black - 80µ**

Permanente lijm - Colle permanente

80	70 x 100	88151882		-	per 100 sheets	1649,75
----	----------	----------	--	---	----------------	---------

**Avery 400 Yellow - 80µ**

Permanente lijm - Colle permanente

80	70 x 100	88105561		-	per 100 sheets	1649,75
----	----------	----------	--	---	----------------	---------

**Opti Serilux Shell Yellow Gloss 74100 - 100µ**

Permanente lijm (Duro E110) - Colle permanente (Duro E110)

100	70 x 100	88105886		-	per 100 sheets	1702,54
-----	----------	----------	--	---	----------------	---------

**Opti Serilux Red Gloss 78100 - 100µ**

Permanente lijm (Duro E110) - Colle permanente (Duro E110)

100	70 x 100	88105905		-	per 100 sheets	1701,36
-----	----------	----------	--	---	----------------	---------

snijkosten frais de découpe	€ 0,03/coupon - forfait € 2,50
toeslag supplément	65 % bij opening van riem 65 % en cas d'ouverture de rame



	ingeriemd per 100 vel/enramé par 100 feuilles
--	---

levertijd 3 tot 4 werkdagen / délai de livraison : 3 à 4 jours ouvrables



## Durable Self Adhesive Screen Films

### Durable Screen Films Mactac - Films Mactac Durables

	forma(a)t cm	ref. Papyrus	info	Rug Dos	verpakking emballage	1  €/1000 vel/feuilles
---	-----------------	-----------------	------	------------	-------------------------	--

#### MACAL 9829 Gloss White Polymeric Film - 80µ

Permanente lijm - Colle permanente

80	70 x 100	88070492			per 100 sheets	4018,81
----	----------	----------	---	--	----------------	---------

#### MACAL 9899 Gloss Clear Polymeric Film - 80µ

Permanente lijm - Colle permanente

80	70 x 100				per 100 sheets	4783,82
----	----------	--	---	--	----------------	---------

### Durable Screen Films Avery Sheets - Films Avery Durables

#### 800 Calandered Screen

Een serie gekalanderde standaard vinylfilms voor middellange termijn met permanente lijm. Duurzaamheid = 5-7 jaar. - 800 Calandered Screen. Série de films vinyles calandrés de durée de vie moyenne. Pourvus d'un adhésif permanent. Durabilité = 5-7 ans.

#### Avery 895 Screen Gloss White Polymeric - 100µ

Permanente lijm - Colle permanente

100	70 x 100	88130146			per 100 sheets	6525,66
-----	----------	----------	---	--	----------------	---------

#### 900 QM Screen.

Gegoten vinyl voor lange termijn en/of toepassingen waar grote flexibiliteit vereist is. Duurzaamheid = 10 jaar.

#### Avery 900 Screen Gloss White Cast - 50µ

Permanente lijm - Colle permanente



50	100 x 70	88105566			per 100 sheets	11771,85
----	----------	----------	--	--	----------------	----------

#### Avery 940 QM Screen Gloss Transparent Cast - 50µ

Permanente lijm - Colle permanente



50	100 x 70	88105567			per 100 sheets	11771,85
----	----------	----------	---	--	----------------	----------

### Durable Screen Films Avery Reels € /m2 - Films Avery Durables En Rouleaux € /m2

#### Avery 895 Screen Gloss White Polymeric - 100µ

Permanente lijm - Colle permanente

100	1m x 250m	#			reel	9,60
-----	-----------	---	---	--	------	------

#### Avery 840 Screen Gloss Transparant Polymeric - 100µ

Permanente lijm - Colle permanente

100	1m x 250m	#			reel	9,60
-----	-----------	---	---	--	------	------

#### 4900 QM Apolar

Cast Vinyl met speciaal ontwikkelde lijm voor een superieure hechting op apolaire oppervlakken (polyethyleen, polypropyleen) en andere moeilijke oppervlakken voor zelfklevende materialen. Duurzaamheid = 7 jaar.

#### Avery 4900 QM Apolar Screen Gloss White Cast - 50µ

Permanente lijm - Colle permanente

50	1m x 50m	#			reel	19,96
----	----------	---	---	--	------	-------



## Special Self Adhesive Screen Films

### Polyester Screen Films Mactac - Films Polyester Mactac

	forma(a)t cm	ref. Papyrus	info	Rug Dos	verpakking emballage	1 €/1000 vel/feuilles
--	-----------------	-----------------	------	------------	-------------------------	--------------------------

**MILMAR TC Gloss Clear Polyester Film - 25μ**

Permanente lijm - Colle permanente

25	70 x 100	88070496		-	per 100 sheets	3007,01
----	----------	----------	--	---	----------------	---------

**MILMAR TC Bright Silver Polyester Film - 25μ**

Permanente lijm - Colle permanente

25	70 x 100	88070497		-	per 100 sheets	3266,13
----	----------	----------	--	---	----------------	---------

**MILMAR TC Dull Silver Polyester Film - 25μ**

Permanente lijm - Colle permanente

25	70 x 100	88070498		-	per 100 sheets	3409,26
----	----------	----------	--	---	----------------	---------

### PET/PVC Screen Films Mactac - Films PET/PVC Mactac

### Aluminium Screen Films Mactac - Films Aluminium Mactac

**Solid Matt Silver Aluminium Film - 40μ**

Permanente lijm - Colle permanente

40	70 x 100	88070506		-	per 50 sheets	4666,60
----	----------	----------	--	---	---------------	---------

### Ultra Destructible Screen Films MacTac - Films Ultra Destructible MacTac

**Ultra Destructible Film - 50μ**

Permanente lijm - Colle permanente

50	70 x 100	88070491		-	per 100 sheets	10552,30
----	----------	----------	--	---	----------------	----------





## Special Self Adhesive Screen Films

### Thick MacTac PVC Films - Films Mactac Epais

	forma(a)t cm	ref. Papyrus	info	Rug Dos	verpakking emballage	1 €/1000 vel/feuilles
--	-----------------	-----------------	------	------------	-------------------------	--------------------------

#### Macal 8229 Gloss White Soft PVC Film - 200μ

Permanente lijm - Colle permanente

200	70 x 100	88070489		-	per 50 sheets	2868,14
-----	----------	----------	--	---	---------------	---------

### Double sided films Mactac - Film Double Face Mactac

#### MacBond B1148 Thin Polyester Film - 12μ

Medium Tack - Colle Semi enlevable

12	70 x 100	88103681		-	per 100 sheets	3811,6832
----	----------	----------	--	---	----------------	-----------



## Special Self Adhesive Screen Films (Vervolg - Suite)

### Polyester Screen Films Avery - Films Polyester Avery

	forma(a)t cm	ref. Papyrus	info	Rug Dos	verpakking emballage	1 €/1000 vel/feuilles
--	-----------------	-----------------	------	------------	-------------------------	--------------------------

#### Avery 710 Chrome Polyester

Permanente lijm - Colle permanente

25	100 x 70	88105565			per 100 sheets	4713,38
----	----------	----------	--	--	----------------	---------

#### Avery 711 Satin Chrome Polyester

Permanente lijm - Colle permanente

25	100 x 70	#	,		per 100 sheets	4713,38
----	----------	---	---	--	----------------	---------

### Aluminium Screen Films Avery - Films Aluminium Avery

#### Avery 180 Solid Foil Matt Aluminium

Permanente lijm - Colle permanente

50	100 x 70	88101064			per 100 sheets	4713,38
----	----------	----------	--	--	----------------	---------

### Ultra Destructible Screen Films Avery - Films Ultra Destructible Avery

#### Avery 2920 QM Ultra Destructible Matt White Cast

Een speciale frontfilm die zeer bros en daardoor slechts moeizaam te verwijderen is. Ideaal voor veiligheidsaanduidingen of waarschuwingsborden. Duurzaamheid = 5 jaar.

Frontal spécial impossible à arracher. Idéal pour les marquages de sécurité ou les signes d'avertissement. Durabilité = 5 ans.

60	100 x 70	88101063			per 100 sheets	8410,04
----	----------	----------	--	--	----------------	---------

### Acetate Screen Films Avery - Films Acétate Avery

#### Avery Acetate Satin Cloth - 125µ

Permanente lijm - Colle permanente

125	50 x 70	88101055			per 150 sheets	2610,88
-----	---------	----------	--	--	----------------	---------

### Avery Gum Twin- Offset Paper 70 gr./m2 - Papier Offset 70 gr./m2 autocollant Ddouble-Face

#### Avery Gum Twin

SuperTack lijm - Colle Super Adhésive

280	50 x 70	88101056			per 150 sheets	1402,56
-----	---------	----------	--	--	----------------	---------

# Papyrus Viscom

Prijslijst / Liste de prix  
Hardware



**PAPYRUS** 

Your partner in Visual Communication



# Hardware

## MUTOH SIGN and DISPLAY

MUTOH ValueJet ECO/UMS PRINTERS . . . . .	249
MUTOH ValueJet 628 . . . . .	249
MUTOH ValueJet 1324X . . . . .	249
MUTOH ValueJet 1604X . . . . .	249
MUTOH ValueJet 1604X - Rip center . . . . .	249
MUTOH XpertJet 1641SR . . . . .	250
MUTOH XpertJet 1682SR . . . . .	250
MUTOH ValueJet 2638X . . . . .	250
MUTOH ValueJet ECO/UMS PRINTERS - OPTIONS . . . . .	250

## MUTOH ValueCut Cutting Plotters

ValueCut RANGE . . . . .	251
MUTOH ValueCut 600 . . . . .	251
MUTOH ValueCut II 1300 . . . . .	251
MUTOH ValueCut II 1800 . . . . .	251
MUTOH ValueCut Options . . . . .	252
MUTOH ValueCut Supplies . . . . .	252

## MUTOH Specialty - Industrial

MUTOH ValueJet LED UV Desktop Printer . . . . .	253
MUTOH ValueJet 426UF . . . . .	253
MUTOH ValueJet 626UF . . . . .	253
MUTOH XpertJet 461UF . . . . .	253
MUTOH XpertJet 661UF . . . . .	253
MUTOH ValueJet LED UV Desktop Printer OPTIONS . . . . .	253
MUTOH ValueJet Roll To Roll Uv Led Printers . . . . .	254
MUTOH ValueJet 1638UR . . . . .	254
MUTOH ValueJet 1638UH . . . . .	254
MUTOH ValueJet Flatbed Uv Led Printers . . . . .	255
PERFORMANCEJET 2508UF LED UV Printer . . . . .	255
MUTOH MP11 Hybrid Printer . . . . .	255
MUTOH ValueJet 1617H . . . . .	255
MUTOH VJ1626UH / VJ1638UH / 1617H Printers Options . . . . .	255

## MUTOH Indoor and Digital Transfer

MUTOH Draftstation Waterbased Printer . . . . .	256
MUTOH Draftstation RJ900XG . . . . .	256
MUTOH ValueJet Waterbased Printer . . . . .	256
MUTOH ValueJet 1604WX . . . . .	256
MUTOH ValueJet 1624WX . . . . .	256
MUTOH ValueJet 1638WX . . . . .	257
MUTOH ValueJet 1924W . . . . .	257
MUTOH ValueJet 1938WX . . . . .	257
MUTOH ValueJet 1948WX . . . . .	257
MUTOH ValueJet 2638X Dye Sub – 102" – 2600 mm . . . . .	258
MUTOH ValueJet Waterbased Printer Options . . . . .	258

## MUTOH Direct Textile

MUTOH ValueJet Td Printers . . . . .	258
MUTOH ValueJet 1938TX . . . . .	258

## MUTOH Accessories

MUTOH Open Cassettes / Bulk Ink Systems . . . . .	258
---	-----

## Sawgrass Virtuoso VJ-628 Printer

Sawgrass Virtuoso VJ-628 Printer . . . . .	259
Sawgrass Virtuoso VJ-628 Printer . . . . .	259
Options for Virtuoso VJ-628 Printer . . . . .	259

## EPSON Indoor and Digital Transfer

SureColor SC-F7200for Chromaluxe sublimation . . . . .	260
SureColor SC-F7200 (nK) . . . . .	260

## EPSON UltraChrome Range

EPSON SureColor SC-S80600 . . . . .	260
EPSON SureColor SC-S80600 . . . . .	260
EPSON SureColor SC-S80600L . . . . .	260

## SUMMA Drag Cutters

SummaCut FX Series . . . . .	261
SummaCut D140FX . . . . .	261
Options for SummaCut FX . . . . .	261
SummaCut Series . . . . .	261
SummaCut D60 . . . . .	261
SummaCut D120 . . . . .	261
SummaCut D140 . . . . .	262
SummaCut D160 . . . . .	262
Options for SummaCut . . . . .	262

## SUMMA Tangential Cutters

S CLASS 2 Series. . . . .	262
S Class 2 160 T. . . . .	262
Options For S Class 2 160T . . . . .	262

## SUMMA Flatbed Cutting System

SUMMA F Series - Mains and Options . . . . .	263
F 1612. . . . .	263
F1612 Electrical wiring options . . . . .	263
F1612 Miscellaneous Options . . . . .	263
F1612 Media Handling Options . . . . .	263
Software. . . . .	263

## SUMMA Flatbed Cutting System

F1612 Modules . . . . .	264
DRAG MODULE - TANGENTIAL MODULE - ROUTER SYSTEM for F1612 - HF ROUTER SYSTEM for F1612 - OTARY MODULE. . . . .	264
SUMMA F Series - Mains and Options . . . . .	265
F1330 . . . . .	265
F1330 Electrical wiring options . . . . .	265
Installation Assistance (MANDATORY) . . . . .	265
F1330 Miscellaneous Options . . . . .	265
Fxx30 Automated Depth Control . . . . .	265
Software. . . . .	265
F1330 Modules . . . . .	266
DRAG MODULE - TANGENTIAL MODULE - ROUTER SYSTEM for F1330 - HF ROUTER SYSTEM for F1330 - ROTARY MODULE . . . . .	266
SUMMA F Series - Mains and Options . . . . .	267
F 1832. . . . .	267
F1832 Electrical wiring options . . . . .	267
Installation Assistance (MANDATORY) . . . . .	267
F 1832 Miscellaneous Options. . . . .	267
Software. . . . .	267
F 1832 Modules. . . . .	268
DRAG MODULE - TANGENTIAL MODULE - ROUTER SYSTEM for F1832 - HF ROUTER SYSTEM for F1832 - ROTARY MODULE . . . . .	268
SUMMA F Series - Mains and Options . . . . .	269
F2630 . . . . .	269
F2630 Electrical wiring options . . . . .	269
Installation Assistance (MANDATORY) . . . . .	269
F2630 Miscellaneous Options . . . . .	269
Fxx30 Automated Depth Control . . . . .	269
Software. . . . .	269
F2630 Modules . . . . .	270
DRAG MODULE - TANGENTIAL MODULE - ROUTER SYSTEM for F2630 - HF ROUTER SYSTEM for F2630 - ROTARY MODULE . . . . .	270
SUMMA F Series - Consumables and Accessories . . . . .	271
Mats and Belts . . . . .	271
Consumables and Accessories for Drag Module . . . . .	271
Tools for Tangential Module . . . . .	271
SUMMA F Series - Consumables and Accessories . . . . .	272
Tools for Tangential Module . . . . .	272
Tools for Tangential Module . . . . .	273
Tools for Tangential Module . . . . .	274
Tools for Tangential Module . . . . .	275
Consumables and Accessories for Tangential Module . . . . .	275
Consumables and Accessories for Routing Module. . . . .	275
Consumables and Accessories for Rotary Module . . . . .	275

## ROLL-X Flatbed Applicator

Roll-X® GO . . . . .	276
RX GO 470/175 . . . . .	276
RX GO 400/175 . . . . .	276
RX GO 327/175 . . . . .	276
Roll-X® Professional . . . . .	277
RX Professional 470/175 . . . . .	277
RX Professional 400/175 . . . . .	277
RX Professional 327/175 . . . . .	277
ROLL-X ACCESSORIES . . . . .	277

## KALA COLD LAMINATORS

STARTER Range . . . . .	278
STARTER 1080 - 108 cm (43 inches) incl. Stand . . . . .	278
STARTER 1400 - 140 cm (55 inches)incl. Stand . . . . .	278
STARTER 1600 - 160 cm (63 inches)incl. Stand . . . . .	278
STARTER WITH UPPER HEATED ROLLER AT 40°C. . . . .	279
STARTER 1080 UH - 108 cm (43 inches) incl. Stand . . . . .	279
STARTER 1400 UH - 140 cm (55 inches)incl. Stand. . . . .	279
STARTER 1600 UH - 160 cm (63 inches)incl. Stand . . . . .	279
BALTIC Range . . . . .	280
BALTIC 1400 - 1,40 m - 55" (delivered with its stand) . . . . .	280

## KALA COLD LAMINATORS WITH TOP HEATED ROLLER

MISTRAL Range . . . . .	280
MISTRAL 1650 - 1,65 m - 65" . . . . .	280
MISTRAL Range . . . . .	281
MISTRAL 2100 - 2,10 m - 83" . . . . .	281
KALA ARKANE Range . . . . .	281
Arkane 1650 - 1,65 m - 65" . . . . .	281

## KALA HOT and COLD LAMINATORS

ARKANE Rang . . . . .	282
Arkane 1650 - 1,65 m - 65"Arkane 1650 D-65 m 65" with double heating 282	
SIROCCO Medium Range.. . . .	282
SIROCCO 1080 - 1,08 m - 42,5" . . . . .	282
SIROCCO 1600 - 1,60 m - 63" . . . . .	282
Atlantic Range. . . . .	283
ATLANTIC 1080 - 1,08 m - 42,5" . . . . .	283
ATLANTIC 1650 - 1,60 m - 63" . . . . .	283
Accessories - Waste paper. . . . .	284

## NEOLT Trimmers

Electro Power Trim Plus Range. . . . .	284
Electro Power Trim Plus145 . . . . .	284
Electro Power Trim Plus 165 . . . . .	284
Electro Power Trim Plus 210 . . . . .	284
Electro Power Trim Plus 250 . . . . .	284

## KEENCUT cutting machines

SteelTrak Vertical Cutter RangeTool . . . . .	285
SteelTrak 165 cm. . . . .	285
SteelTrak 210 cm. . . . .	285
SteelTrak 250 cm. . . . .	285
Accessories for Steeltrak . . . . .	285
Blades and cutting wheels for Steeltrak . . . . .	286
SteelTraK V-Grooving tools - 90° angle . . . . .	286
Evolution 2160. . . . .	286
Evolution 2210. . . . .	286
Evolution 2260. . . . .	286
Evolution 2310. . . . .	286
Evolution 2360. . . . .	286

## SEFA Heat presses

SEFA Chromaluxe Compatible Press . . . . .	287
Rotex Air Pro XL: Automatic Closing, opening and rotation • 1 Heating Zone 287	
SLIDE 865: Automatic Closing and opening • 2 Heating Zones . . . . .	287
SLIDE 1285: Automatic Closing and opening • 2 Heating Zones . . . . .	287
Subli 1510+: Double motorized drawer plates • 2 Heating Zones . . . . .	287
SubliMax 1812: Double motorized drawer plates • 4 Heating Zones . . . . .	288
SubliMax 2513: Double motorized drawer plates • 4 Heating Zones . . . . .	288
Comp-74 . . . . .	288

Comp-111 . . . . .	289
Comp-240 . . . . .	289
Comp-300 . . . . .	289
SEFA Accessories . . . . .	289

## STAHL'S Heat Presses

Basic Range • Attractive price • Digital time and temperature readout . . . . .	290
STAHL'S Clam Basic blue 38 x 28 cm . . . . .	290
STAHL'S Clam Basic blue 38 x 38cm . . . . .	290
STAHL'S Clam Basic blue 40 x 50cm . . . . .	290
STAHL'S Clam Basic "Cap" blue 9 x 16cm. . . . .	290
Maxx Range . . . . .	290
STAHL'S MAXX Clam 28 x 38cm . . . . .	290
Maxx Range . . . . .	291
STAHL'S MAXX Clam 38 x 38cm . . . . .	291
STAHL'S MAXX Clam 40 x 50cm . . . . .	291
STAHL'S MAXX Cap 9 x 16cm . . . . .	291
Sprint Mag Range . . . . .	292
The gold standard for multi-taskers • Magnetic auto-open feature • Twin Timer for preheating or two-step applications • Interchangeable Lower Platens. . . . .	292
STAHL'S Sprint Mag XS 15 x 15cm . . . . .	292
STAHL'S Sprint Mag Digital 28 x 38cm . . . . .	292
STAHL'S Sprint Mag Digital 40 x 40cm . . . . .	292
STAHL'S Sprint Mag Digital 40 x 50cm . . . . .	292
STAHL'S Sprint Mag Hover 40 x 50cm . . . . .	292
STAHL'S Sprint Mag Cap 9 x 16cm . . . . .	292
Hotronix Fusion Range . . . . .	293
STAHL'S Hotronix Fusion 40 x 50cm . . . . .	293
Hotronix Air Fusion Range . . . . .	293
STAHL'S Hotronix Air Fusion 40 x 50cm . . . . .	293
STAHL'S Hotronix Air Fusion TableTop 40 x 50cm . . . . .	293
Hotronix Air Fusion Range . . . . .	294
STAHL'S Hotronix DualAir Fusion 40 x 50cm with Laser Alignment System . . . . .	294
Accessories . . . . .	294

## CANON PRINTERS

CANON iPF PRO 8 Colour Printers. . . . .	295
iPF PRO-4000S . . . . .	295
iPF PRO-6000S . . . . .	295
CANON iPF PRO 12 Colour Printers . . . . .	295
iPF PRO-1000 . . . . .	295
iPF PRO-2000 . . . . .	295
iPF PRO-4000 . . . . .	295
iPF PRO-6000 - 60" - 11 clrs - . . . . .	295
CANON iPF - 5 COLOUR PRINTERS . . . . .	295
iPF510 . . . . .	295
iPF610 . . . . .	295
iPF670 . . . . .	295
iPF680 . . . . .	295
iPF685 . . . . .	295
iPF770 (Printer Stand INCLUDED) . . . . .	295
iPF780 (Printer Stand INCLUDED) . . . . .	295
iPF785 (Printer Stand INCLUDED) . . . . .	295
CANON TX SERIES - 5 COLOUR PRINTERS . . . . .	295
TX-2000 - 609,6mm . . . . .	295
TX-3000 - 914,4mm . . . . .	2443C003AA
TX-4000 - 1117,6mm . . . . .	295

## CANON PRINTERS

CANON imagePROGRAF TM-Series - 5 COLOUR PRINTERS . . . . .	296
TM-300 - 914,4mm - Stand Included . . . . .	296
CANON MFP SOLUTIONS. . . . .	296
iPF770 MFP . . . . .	296
iPF780 MFP . . . . .	296
iPF785 MFP . . . . .	296
MFP Solution T36 Scanner with PC - TX-3000 . . . . .	296
MFP Solution T36 Scanner with PC - TX-4000 . . . . .	296
MFP Solution with L - Scanner . . . . .	296



# MUTOH

## MUTOH SIGN and DISPLAY

Description	Ref. Papyrus	€
-------------	-----------------	---

### MUTOH ValueJet ECO/UMS PRINTERS

<b>MUTOH ValueJet 628</b>	<b>VJ-628</b>	<b>5 995,00</b>
---------------------------	---------------	-----------------



- VJ-628 ValueJet 628 – 24" – 630 mm – 8 channels
- Printer installer and driver software Win XP, Vista, 7, 8, 8.1
  - 2"/3" compatible media scroller
  - Onyx Launcher MUTOH Edition RIP for ValueJet 628
  - no stand, no take-up, no ink set
  - no cleaning cassettes for first wash included

<b>MUTOH ValueJet 1324X</b>	<b>VJ-1324X</b>	<b>8 995,00</b>
-----------------------------	-----------------	-----------------



- ValueJet 1324X – 54" – 1371 mm
- 4 cleaning cassettes (needed to start up printer - first wash)
  - 2"/3" compatible media scroller
  - Onyx Launcher MUTOH Edition RIP for ValueJet 628
  - RIPCenter ValuePlus MUTOH Edition (SRM-RIPCTR-MUT) or FlexiPRINT SE MUTOH Edition (FPSEME12)
  - no ink, no take-up system

<b>MUTOH ValueJet 1604X</b>	<b>VJ-1604X</b>	<b>9 995,00</b>
-----------------------------	-----------------	-----------------



- ValueJet 1604X – 64" – 1625 m
- 4 cleaning cassettes (needed to start up printer - first wash)
  - 30kg Torque Winder (VJ1619-TUP30)
  - SAi FlexiPRINT SE MUTOH Edition Software (FPSEME12) or + Onyx VJ-1604X Edition Software (SRM-RIPQ-1604X) no ink

<b>MUTOH ValueJet 1604X - Rip center</b>	<b>VJ-1604X</b>	<b>10 495,00</b>
--	-----------------	------------------



- ValueJet 1604X – 64" – 1625 m
- 4 cleaning cassettes (needed to start up printer - first wash)
  - 30kg Torque Winder (VJ1619-TUP30)
  - Onyx RIPCenter ValuePlus MUTOH Edition Software (SRM-RIPCTR-MUT) no ink

## MUTOH SIGN and DISPLAY

Description	Ref. Papyrus	€
-------------	-----------------	---

### MUTOH ValueJet ECO/UMS PRINTERS

<b>MUTOH XpertJet 1641SR</b>	<b>XPJ-1641SR</b>	<b>13 995,00</b>
------------------------------	-------------------	------------------



- XpertJet 1641SR – 64" – 1625 mm – single head - CMYK with 30 kg torque winder (VJ1619-TUP30)
- 1 set (2 pcs) of media feed flanges – 1 kg torque
  - 1 set of ink pack cases - (INKCASE-1000 – set of 4 pcs)
  - RIP software RIPCenter MUTOH Ed. (SRX-RIPCTR-MUT) or PhotoPrint SE MUTOH Ed.
  - no Ink

<b>MUTOH XpertJet 1682SR</b>	<b>XPJ-1641SR</b>	<b>19 995,00</b>
------------------------------	-------------------	------------------



- XpertJet 1682SR – 64" – 1625 mm – dual head – CMYK x 2 or CMYK, Lm, Lc, Lk with 30 kg torque winder (VJ1619-TUP30)
- 1 set (2 pcs) of media feed flanges – 1 kg torque
  - 2 sets of ink pack cases – (2 x INKCASE-1000 – set of 4 pcs)
  - RIPCenter ValuePlus MUTOH Edition (SRM-RIPCTR-MUT) or FlexiPRINT SE MUTOH Edition (FPSEME12)
  - no ink, no take-up system

<b>MUTOH ValueJet 2638X</b>	<b>VJ-2638</b>	<b>38 995,00</b>
-----------------------------	----------------	------------------



- ValueJet 2638X – 102" – 2600 mm
- 8 cleaning cassettes (needed to start up printer - first wash)
  - RIPCenter ValuePlus MUTOH Edition (SRM-RIPCTR-MUT) or FlexiPRINT SE MUTOH Edition (FPSEME12)
  - 100 kg unwinder/winder system; ZMY-14630
  - no ink

### MUTOH ValueJet ECO/UMS PRINTERS - OPTIONS

ValueJet 628 start-up kit containing 8 cleaning cassettes and 8 Eco Ultra ink cassettes for initial start-up and first ink load	VJ-MSI3A-2x4	799
Stand for ValueJet 628	VJ628-STD	345
Ink adapter set (set contains 4 adapters) for Eco Ultra ink litre packs	VJ-HCIPADPT	395
Ink adapter set (set contains 4 adapters) for UMS ink litre packs	VJ-HCIPADPT-UMS	695
UMS Ink Pack Starter Kit - contains Ink Pack Adapter Set (VJ-HCIPADPT-UMS) and 1CMYK set of UMS litre ink packs	KY-81900	999
10 kg torque winder for ValueJet 628	VJ06-TUP10	955
20 kg torque winder for ValueJet 1324X	VJ1213-TUP20	975
30 kg torque winder for ValueJet 1604X*, 1624X and ValueJet 1638X	VJ1619-TUP30	995
30 kg automatic motorised take-up system with tension bar for ValueJet 1624 and 1638X	VJ16-TUP30U	1995

# MUTOH

## MUTOH ValueCut Cutting Plotters

Description	Ref. Papyrus	€
<b>ValueCut RANGE</b>		
MUTOH ValueCut 600	VC-600	1 995,00



ValueCut 600 – 24" – 610 mm

- media width 770 mm
- no stand, no media support rollers
- Includes blade holder, ball-point holder, standard knife 45° (Red Cap) and safe blade for sheet-off.
- FlexiSTARTER ValueCut Cloud Edition (11): text and graphics layout for vinyl cutting. Powerful graphics import and export for contour cut

MUTOH ValueCut II 1300

VC2-1300

3 995,00



ValueCut II 1300 – 52" – 1320 mm

- media width 1594 mm
- plotter stand and basket, wheels and media support rollers
- Includes blade holder, ball-point holder, standard knife 45° (Red Cap) and safe blade for sheet-off.
- FlexiSTARTER ValueCut Cloud Edition (11): text and graphics layout for vinyl cutting. Powerful graphics import and export for contour cut.

MUTOH ValueCut II 1800

VC2-1800

4 995,00



ValueCut II 1800 – 72" – 1830 mm

- media width 1900 mm
- plotter stand and basket, wheels and media support rollers
- Includes blade holder, ball-point holder, standard knife 45° (Red Cap) and safe blade for sheet-off.
- FlexiSTARTER ValueCut Cloud Edition (11): text and graphics layout for vinyl cutting. Powerful graphics import and export for contour cut.

## MUTOH ValueCut Cutting Plotters

Description	Ref. Papyrus	€
<b>ValueCut RANGE</b>		
<b>MUTOH ValueCut Options</b>		
Optional stand and basket for ValueCut 600	VC-STD-600	345,00
<b>MUTOH ValueCut Supplies</b>		
Blade Holder (No Blade Inside)	VC-CHD	137,00
5 pcs - cutting blade 45° / 0,25 mm / Red Cap for thick fluorescent, reflective and standard PVC	VC-CBRE5	77,00
1 pc - cutting blade 60° / 0,5 mm / Green Cap for reflective PVC, Cardboard, Sandblast and Flock	VC-CBGR1	66,00
1 pc - cutting blade 60° / 0,25 mm / Blue Cap for thin sandblast mask and stencil	VC-CBBU1	58,00
1 pc - cutting blade 42° / 0,175 mm / Black Cap for small text and fine details	VC-CBBK1	58,00
5 pcs - cutting blade 25° / 0,25 mm / Yellow Cap for thin and delicate media such as window tint	VC-CBYE5	77,00
Ball-point Pen Holder Assembly with Package	PSGB-BK	101,00
Cutting Mat (W: 6 mm * L: 10 m)	VC-CMAT	53,00
Pouncing Tool Assembly	VC-PT	128,00
Pouncing Mat (1.5 m/roll)	VC-PMAT	12,00
Safe Blade – Manual sheet-off knife which fits the integrated cutting groove.	VC-SB	6,00

## MUTOH Specialty - Industrial

Description	Ref. Papyrus	€
<b>MUTOH ValueJet LED UV Desktop Printer</b>		
<b>MUTOH ValueJet 426UF</b>	<b>VJ-426UF</b>	<b>16 995,00</b>
 <p>ValueJet 426UF A3+ Desktop LED UV Printer – 6 channels</p> <ul style="list-style-type: none"> <li>• Max. media size : 483 mm x 329 mm x 70 mm</li> <li>• Max. print size : 473 mm x 319 mm</li> <li>• 6 x cleaning cassettes for initial wash</li> <li>• Printer installer and driver software Windows XP, Vista, 7, 8, 8.1</li> <li>• Head gap guide bar</li> <li>• no ink, no software</li> </ul>		
<b>MUTOH ValueJet 626UF</b>	<b>VJ-626UF</b>	<b>26 995,00</b>
 <p>ValueJet 626UF A2 Desktop LED UV Printer – 6 channels</p> <ul style="list-style-type: none"> <li>• Max. media size : 594 mm x 483 mm x 150 mm</li> <li>• Max. print size : 54 mm x 473 mm</li> <li>• Max. Media Thickness : Up to 150 mm</li> <li>• Automatic table lift system with obstacle detection laser</li> <li>• 6 x cleaning cassettes for initial wash</li> <li>• Printer installer and driver software Windows XP, Vista, 7, 8, 8.1</li> <li>• Head gap guide bar</li> <li>• no ink, no software</li> </ul>		
<b>MUTOH XpertJet 461UF</b>	<b>XP-461UF</b>	<b>16 995,00</b>
 <p>XpertJet 461UF A3+ Desktop LED UV Printer – 6 channels</p> <ul style="list-style-type: none"> <li>• Max. media size : 483 mm x 329 mm x 70 mm (or 150mm. without table)</li> <li>• Max. print size : 483 mm x 329 mm</li> <li>• 6 x cleaning cassettes for initial wash</li> <li>• Printer installer and driver software Windows XP, Vista, 7, 8, 8.1</li> <li>• Head gap guide bar</li> <li>• no ink, no software</li> </ul>		
<b>MUTOH XpertJet 661UF</b>	<b>XP-661UF</b>	<b>26 995,00</b>
 <p>XpertJet 661UF A2 Desktop LED UV Printer – 6 channels</p> <ul style="list-style-type: none"> <li>• Max. media size : 594 mm x 483 mm x 150 mm</li> <li>• Max. print size : 594 mm x 483 mm</li> <li>• Max. Media Thickness : Up to 150 mm</li> <li>• Automatic table lift system with obstacle detection laser</li> <li>• 6 x cleaning cassettes for initial wash</li> <li>• Printer installer and driver software Windows XP, Vista, 7, 8, 8.1</li> <li>• Head gap guide bar</li> <li>• no ink, no software</li> </ul>		
<b>MUTOH ValueJet LED UV Desktop Printer OPTIONS</b>		
Vacuum table for XpertJet 461 UF	IJ-TBLV-01	1995,00
Optional Stand for ValueJet 626UF	VJ626-STD	799,00
Rotary option unit compatible with XPJ-661UF and VJ-626UF	IJ-RTU-01	2800,00

## MUTOH Specialty - Industrial

Description	Ref. Papyrus	€
<b>MUTOH ValueJet Roll To Roll Uv Led Printers</b>		
<b>MUTOH ValueJet 1638UR</b>	<b>VJ-1638UR</b>	<b>22 995,00</b>

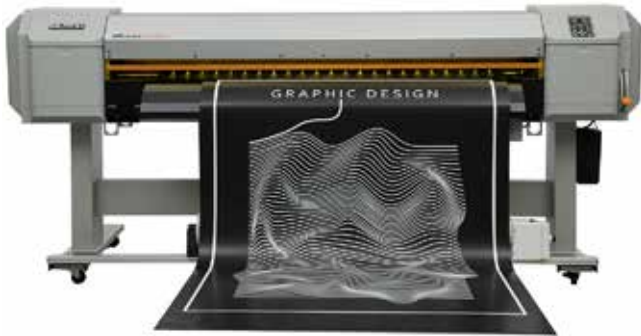

ValueJet Hybrid 1638UR Roll-to-Roll printer - 64"/1625 mm – 8 channels

- Max. Print Width: 1625 mm
- Max. Media Thickness: 1,3 mm
- Print Head: 2
- LED UV inks - Flexible types - CMYK or CMYK + White + Varnish
- Includes take-up system 30 kg (VJ1619-TUP30)
- 8 x cleaning cassettes for initial wash
- no ink, no software

<b>MUTOH ValueJet 1638UH</b>	<b>VJ-1638UH</b>	<b>39 995,00</b>
------------------------------	------------------	------------------



ValueJet Hybrid 1638UH Rigid and Roll-to-Roll printer - 64"/1625 mm – 8 channels

- Max. Print Width: 1625 mm
- Max. Media Thickness: 15 mm
- Print Head: 2
- LED UV inks - Rigid and Flexible types - CMYK or CMYK + White + Varnish
- 8 x cleaning cassettes for initial wash
- no ink, no software, no take-up system, no rigid tables



## MUTOH Specialty - Industrial

Description	Ref. Papyrus	€
<b>MUTOH ValueJet Flatbed Uv Led Printers</b>		
<b>PERFORMANCEJET 2508UF LED UV Printer</b>	<b>PF-2508UF</b>	<b>74 995,00</b>



- 1250 x 2540 mm (4'x8') flatbed LED UV printer • Variable drop greyscale print heads
- Media thickness up to 100 mm (4")
- Media weight up to 50 kg / m2
- Low energy consumption and low temperatures, ideal for heat sensitive materials
- Print bed with multiple vacuum zones
- Automatic media registration pin system for multi panel jobs and double sided prints
- Vacuum bed blowing function for easy media positioning
- Edge-to-edge borderless printing

### MUTOH MP11 Hybrid Printer

<b>MUTOH ValueJet 1617H</b>	<b>VJ-1617H</b>	<b>29 990,00</b>
ValueJet Hybrid 1617H - 64" – 1625 mm		
+ ink pack adapter set		
+ rigid tables (2 x VJ1617H-TBL)		
no cleaning for initial wash included		
no ink, no take-up system		

### MUTOH VJ1626UH / VJ1638UH / 1617H Printers Options

30 kg torque winder for ValueJet 1617H and ValueJet 1638UH	VJ1619-TUP30	995,00
30 kg automatic motorised take-up system with tension bar for ValueJet Hybrid VJ-1617H and VJ-1638UH	VJ16-TUP30U	1 995,00
100 kg automatic motorised take-up system with tension bar for ValueJet 1638UH	VJ19-TUP100U	6 495,00
Rigid table – compatible with VJ-1617H and VJ-1638UH	VJ1617H-TBL	1 995,00
Roller arm for rigid table VJ-1617H/VJ-1626UH (a standard table contains 3 roller arms)	VJ1617H-RLR	195,00
Media Alignment Option for VJ-1626UH	VJ16-MRT	699,00
Media Alignment Option for VJ-1638UH	VJ19-MRT	849,00
Table Kit for ValueJet 1638UH (incl. 2 tables, 4 rollers bars, 1 media alignment option)	TABLE-KIT	5 089,00

## MUTOH Indoor and Digital Transfer

Description	Ref. Papyrus	€
<b>MUTOH Draftstation Waterbased Printer</b>		
<b>MUTOH Draftstation RJ900XG</b>	<b>RJ-900XG</b>	<b>3 990,00</b>



DrafStation RJ-900X A0-size

- Max. print Width: 1074 mm
- Max. Media Thickness 0,3 mm / 1.3 mm
- Print Head: 1
- Ink Type: DS2-series Universal Transfer Sublimation ink
- stand including 2" media scroller
- no software, no ink, no cleaning, no take-up system

### MUTOH ValueJet Waterbased Printer

<b>MUTOH ValueJet 1604WX</b>	<b>VJ-1604WX</b>	<b>9 995,00</b>
------------------------------	------------------	-----------------



ValueJet 1604WX – 64" – 1625 mm printer

- Max. print Width: 1615 mm
- Max. Media Thickness: 0,3 mm / 1,3 mm
- Print Head: 1
- 30 kg torque winder (VJ1619-TUP30)
- Ink Type: Water-based Universal Transfer Sublimation inks (DS2-series)
- SAi FlexiPRINT SE MUTOH Edition Software (FPSEME12)
- no ink, no cleaning

<b>MUTOH ValueJet 1624WX</b>	<b>VJ-1624WX</b>	<b>13 490,00</b>
------------------------------	------------------	------------------



ValueJet 1624W – 64" – 1625 mm

- Max. print Width: 1615 mm
- Max. Media Thickness: 0,3 mm / 1,3 mm / 2,8 mm
- Print Head: 1
- Ink Type: Disperse Dye Sublimation
- no software, no ink, no cleaning, no take-up system



## MUTOH Indoor and Digital Transfer

Description	Ref. Papyrus	€
<b>MUTOH ValueJet Waterbased Printer</b>		
<b>MUTOH ValueJet 1638WX</b>	<b>VJ-1638WX</b>	<b>20 990,00</b>



ValueJet 1638WX – 64" – 1625 mm

- Max. print Width: 1615 mm
- Max. Media Thickness: 0,3 mm / 1,3 mm / 2,8 mm
- Print Head: 2
- Ink Type: DS2-series Universal Transfer Sublimation ink
- no software, no ink, no cleaning, no take-up system

**MUTOH ValueJet 1924W**

**VJ-1924W**

**16 990,00**



ValueJet 1924W – 75" – 1910 mm

- Max. print Width: 1900 mm
- Max. Media Thickness: 0,3 mm / 1,3 mm / 2,8 mm
- Print Head: 1
- Incl. VJ1619-TUP30 30 kg torque winder
- Ink Type: DS2-series Universal Transfer Sublimation ink
- no software, no ink

**MUTOH ValueJet 1938WX**

**VJ-1938WX**

**24 990,00**



ValueJet 1938WX – 75" – 1910 mm

- Max. print Width: 1900 mm
- Max. Media Thickness: 0,3 mm / 1,3 mm / 2,8 mm
- Print Head: 2 (staggered setup)
- Incl. VJ1619-TUP30 30 kg torque winder
- Ink Type: DS2-series Universal Transfer Sublimation ink
- no software, no ink, no cleaning

**MUTOH ValueJet 1948WX**

**VJ-1948WX**

**44 995,00**

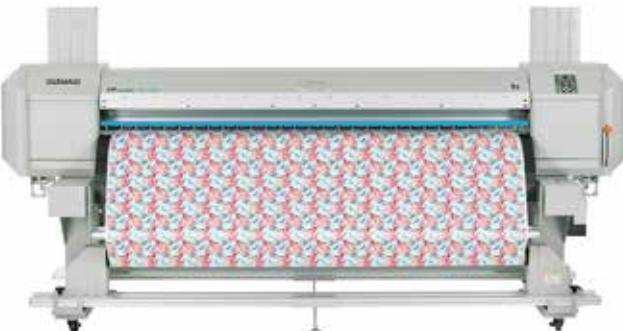

ValueJet 1948WX – 75" – 1910 mm

- Max. print Width: 1900 mm
- Max. Media Thickness: 0,3 mm / 1,3 mm / 2,8 mm
- Print Head: 4 (staggered setup)
- Incl. VJ19-TUP100U 100 kg winder system
- BIS connection parts
- Ink Type: Water-based Transfer Sublimation Inks
- no software, no ink, no cleaning

# MUTOH

## MUTOH Indoor and Digital Transfer

Description	Ref. Papyrus	€
<b>MUTOH ValueJet Waterbased Printer</b>		
<b>MUTOH ValueJet 2638X Dye Sub – 102" – 2600 mm</b>	<b>VJ-2638X</b>	<b>38 995,00</b>



ValueJet 2638W Dye Sub – 102" – 2600 mm

- Max. print Width: 1900 mm
- Max. Media Thickness: 0,3 mm / 1,3 mm / 2,8 mm
- Print Head: 2 (staggered setup)
- Incl .unwinder/winder 100 kg (media width 2600 mm) ZMY-14630
- Ink Type: Disperse Dye Sublimation
- no software, no ink, no cleaning

### MUTOH ValueJet Waterbased Printer Options

Scroller flange adapter to allow mounting media with a 3" core (1 set of 2 pieces) for DrafStation RJ-900XG	DE-36681	33,00
2" scroller assy for DrafStation RJ-900XG	RJ9-SR02	180,00
20 kg torque winder for DrafStation RJ-900XG	VJ1213-TUP20	975,00
30 kg torque winder for ValueJet 1624WX, ValueJet 1638WX, ValueJet 1924W and ValueJet 1938WX (Standard included with VJ-1924W/1938WX)	VJ1619-TUP30	995,00
30 kg automatic motorised take-up system with tension bar for ValueJet 1624W and 1638WX	VJ16-TUP30U	1 995,00
100 kg automatic motorised take-up system with tension bar (unwinder / winder 100) for ValueJet 1624W and 1638WX	ZMY-14600	4 990,00
100 kg automatic motorised take-up system with tension bar for ValueJet 1924W and 1938WX	VJ19-TUP100U	TBA
Weights upgrade kit for VJ26TUP100 (VJ26TUP100 standard on ValueJet 2628TD)	ZMY-14850	280,00
Pre-mounted pressure arms for VJ-2638X - to be ordered in combination with VJ-2638X Dye Sub	ZMY-12954B	Free of charge

## MUTOH Direct Textile

### MUTOH ValueJet Td Printers

<b>MUTOH ValueJet 1938TX</b>	<b>VJ-1938TX</b>	<b>37 995,00</b>
------------------------------	------------------	------------------



ValueJet 1938TX printer – 75" – 1910 mm

- Max. print Width: 1900 mm
- Max. Media Thickness: 1,3 mm / 2,3 mm / 3,5 mm
- Print Head: 2 (staggered setup)
- Motorized fabric feeding, tensioning and take-up system for textile rolls up to 100 kg
- Ink Type: Water-based Pigmented Direct Textile inks for Cotton, silk, rayon, mixed fibre, PES  
or Water-based Universal Sublimation inks (DS2-series) for Polyester and mixed fibre (min 80 % PES)
- no ink, no software

## MUTOH Accessories

### MUTOH Open Cassettes / Bulk Ink Systems

Open cassette + funnel for ink load and cleaning for MUTOH dye sublimation, direct	KY-08701	46,00
Ink adapter set (1 set contains 4 adapters) for Eco Ultra ink litre packs	VJ-HCIPADPT	395,00
Ink adapter set (1 set contains 4 adapters) for UMS ink litre packs	VJ-HCIPADPT-UMS	695,00
Ink adapter set (set contains 8 adapters) for LED UV ink packs 1 set needed for ValueJet 1638UH printer	VJ-HCIPADPT-UV8	745,00
Bulk Ink System – 4 bottle / 4 cassettes (for horizontal use with float detection, no chip readers)	ZMY-08909	395,00

## Sawgrass Virtuoso VJ-628 Printer

Description	Ref. Papyrus	€
Sawgrass Virtuoso VJ-628 Printer		
<b>Sawgrass Virtuoso VJ-628 Printer</b>	<b>Virtuoso VJ-628</b>	<b>4 990,00</b>



Virtuoso VJ-628 – 24" – 630 mm – 8 channels

- Virtuoso Print Manager included
- 2"/3" compatible media scroller
- no stand, no take-up, no ink set
- no cleaning cassettes for first wash included
- Certified for Chromaluxe Printing

### Options for Virtuoso VJ-628 Printer

Sawgrass Virtuoso VJ-628 Printer Stand88270824		345,00
Sawgrass Virtuoso VJ-628 Printer Take-up88270825		955,00
Wasach RIP Sawgrass Virtuoso Edition	WPS603-MUTOH	1 495,00

## EPSON Indoor and Digital Transfer

Description	Ref. Papyrus	€
SureColor SC-F7200for Chromaluxe sublimation		
<b>SureColor SC-F7200 (nK)</b>	<b>C11CD68301A0</b>	<b>12.995</b>



- SureColor SC-F7200 - 64" (162,6 cm.) - 4 channels
- Ink Technology: UltraChrome® DS
  - Print Head: 1 (PrecisionCore TFP)
  - 1000 ml. Cartridge: Black, Cyan, Yellow, Magenta
  - Take-Up
  - Rip:

## EPSON UltraChrome Range

Description	Ref. Papyrus	€
EPSON SureColor SC-S80600		
<b>EPSON SureColor SC-S80600</b>	<b>SureColor SC-S80600</b>	<b>20 295,00</b>



- SureColor SC-S80600 - 64" (162,6 cm.) - 10 channels
- Ink Technology: UltraChrome® GS3 with Red and Orange
  - Print Head: 2 (staggered setup)
  - 700 ml. Cartridge: Black, Light Black, Metallic Silver, Cyan, Light Cyan, Yellow, Magenta, Light Magenta, Red, Orange, White
  - Take-Up
  - Rip: EPSON Edge, Caldera SignRip EPSON Edition, ONYX POSTERSHOP

**EPSON SureColor SC-S80600L**

**SureColor SC-S80600L**

**23.695,00**



- SureColor SC-S80600 - 64" (162,6 cm.) - 10 channels
- Ink Technology: UltraChrome® GS3 with Red and Orange
  - Print Head: 2 (staggered setup)
  - 700 ml. Cartridge: Black, Light Black, Metallic Silver, Cyan, Light Cyan, Yellow, Magenta, Light Magenta, Red, Orange, White
  - Take-Up
  - Rip: EPSON Edge, Caldera SignRip EPSON Edition, ONYX POSTERSHOP



## SUMMA Drag Cutters

Description	Ref. Papyrus	€
<b>SummaCut FX Series</b>		
<b>SummaCut D140FX</b>	<b>D140RFX-2E</b>	<b>3 990,00</b>
 <p>SummaCut D140FX - 135 cm drag knife cutter with limited pinch roller positions</p> <ul style="list-style-type: none"> <li>• Stand</li> <li>• Media support system with 2 core holders</li> <li>• OPOS X – Technology</li> <li>• Manual cut-off knife + spare blade</li> <li>• Fuse</li> <li>• Drag knife holder + 2 drag knives and fibre tip pen</li> <li>• SUMMA Cutter Control Software</li> <li>• MacSign Cut and WinPlot Cutting Software</li> <li>• Operation manual and quick start (EN/FR/DE/IT/SP/NL)</li> <li>• Power cord and USB cable</li> </ul>		
<b>Options for SummaCut FX</b>		
Basket D140 Packed Summa	399-720	390,00
<b>SummaCut Series</b>		
<b>SummaCut D60</b>	<b>D60RL-2E</b>	<b>1 990,00</b>
 <p>SummaCut D60 - 60 cm drag knife desktop cutter</p> <ul style="list-style-type: none"> <li>• Media support system with 2 core holders</li> <li>• OPOS X – Technology</li> <li>• Manual cut-off knife + spare blade</li> <li>• Fuse</li> <li>• Drag knife holder + 2 drag knives and fibre tip pen</li> <li>• SUMMA Cutter Control Software</li> <li>• MacSign Cut and WinPlot Cutting Software</li> <li>• Operation manual and quick start (EN/FR/DE/IT/SP/NL)</li> <li>• Power cord and USB cable</li> </ul>		
<b>SummaCut D120</b>	<b>74003737</b>	<b>4 290,00</b>
 <p>SummaCut D120 - 120 cm drag knife cutter</p> <ul style="list-style-type: none"> <li>• Stand and basket</li> <li>• Media support system with 2 core holders</li> <li>• OPOS X – Technology</li> <li>• Manual cut-off knife + spare blade - Fuse</li> <li>• Drag knife holder + 2 drag knives and fibre tip pen</li> <li>• SUMMA Cutter Control Software - MacSign Cut and WinPlot Cutting Software</li> <li>• Operation manual and quick start (EN/FR/DE/IT/SP/NL)</li> <li>• Ethernet connectivity</li> <li>• Power cord and USB cable</li> </ul>		





## SUMMA Drag Cutters

Description	Ref. Papyrus	€
<b>SummaCut Series</b>		
<b>SummaCut D140</b>	<b>74003738</b>	<b>5 640,00</b>



SummaCut D140 - 135 cm drag knife cutter

- Stand and basket
- Media support system with 2 core holders
- OPOS X – Technology
- Manual cut-off knife + spare blade - Fuse
- Drag knife holder + 2 drag knives and fibre tip pen
- SUMMA Cutter Control Software - MacSign Cut and WinPlot Cutting Software
- Operation manual and quick start (EN/FR/DE/IT/SP/NL)
- Ethernet connectivity
- Power cord and USB cable

**SummaCut D160**

**74003739**

**6 990,00**



SummaCut D160 – 158 cm drag knife cutter

- Stand and basket
- Media support system with 2 core holders
- OPOS X – Technology
- Manual cut-off knife + spare blade - Fuse
- Drag knife holder + 2 drag knives and fibre tip pen
- SUMMA Cutter Control Software - MacSign Cut and WinPlot Cutting Software
- Operation manual and quick start (EN/FR/DE/IT/SP/NL)
- Power cord and USB cable

### Options for SummaCut

Stand for D60 model	399-050	195,00
Stand with Basket for D60 model	399-075	295,00

## SUMMA Tangential Cutters

### S CLASS 2 Series

<b>S Class 2 160 T</b>	<b>S2T160-2E</b>	<b>10 990,00</b>
------------------------	------------------	------------------



S Class 2 160 T – 157.5 cm tangential knife cutter

- Stand and basket
- 2 core holders
- OPOS X – Technology
- Correct automatic sheet-off system
- Standard knives (2), standard knife holder, standard nose piece, sandblast knife and nose piece, drag knife holder (incl. drag knife), ballpoint holder (incl. pen), pouncing pin and holder
- SUMMA Cutter Control Software
- MacSign Cut and WinPlot Cutting Software
- Operation manual and quick start (EN/FR/DE/IT/SP/NL)
- Power cord and USB cable

### Options For S Class 2 160T

Media-rack with 3 pairs of core holders (Not compatible with roll-up system)	399-396	315,00
Roll-up system with one pair of core holders (Not compatible with media-rack)	399-359	390,00



## SUMMA Cutters Accessories

Description	Ref. Papyrus	€
<b>SUMMA Drag Knife tools</b>		
SUMMA STANDARD DRAG KNIFE HOLDER 1,5 mm	74003056	68,00
SUMMA DRAG KNIFE 36° 1,5mm (5X)	74003052	105,00
SUMMA Drag Knife 60° dia: 1,5mm Offset: 0.5mm	74003123	29,00
SUMMA DRAG KNIFE HOLDER 2 MM (COPPER)	74003071	77,00
SUMMA DRAG KNIFE 55° 2MM(5X)	74003070	130,00
<b>Tangential knives Summa</b>		
SUMMA KNIFE INSTALL TOOL	74003094	9,00
SUMMA NOSE PIECE, STANDARD	74003095	68,00
Summa Tang.Knife Holder 395-322	88209230	89,00
SUMMA STANDARD TANG. KNIFE 36° (5X)	74003053	170,00
SUMMA TANG DOUBLE TIP KNIFE 36°	74003057	54,00
SUMMA TANG KNIFE 45°,WEDGE 40/25°	74003127	44,00
SUMMA TANG KNIFE 60° SANDBLAST	74003051	40,00
SUMMA ASSY, NOSE PIECE DRAG KNIFE	74003330	35,00
SUMMA TANG. DRAGKNIFE HOLDER	74003327	74,00
SUMMA DRAG KNIFE 36° 1.5mm (5X)	74003052	105,00
SUMMA Drag Knife 60° dia: 1.5mm Offset: 0,5mm	74003123	29,00
SUMMA CUTTING STRIP 500 --> 760	74003059	9,00
SUMMA CUTTING STRIP 1000-->1300&S75&120	74003050	12,00
SUMMA CUTTING STRIP 1400-->1600&140&160	74003060	17,00
SUMMA RAZOR BLADES (10)	74003083	10,00

## SUMMA Flatbed Cutting System

### SUMMA F Series - Mains and Options

<b>F 1612</b>	<b>F1612-12</b>	<b>44 600,00</b>
---------------	-----------------	------------------



SUMMA F1612 : Packed cutting table; working area 160x120cm

- Vacuum Pack: Pump 1,3kW, sound absorber, switching valve
- Conveyor System with 3 Pneumatic Media Clamps and Roll-support.
- Safety Pack: Four pole laserbeam system
- Drag Module
- Camera system
- Automatic Depth Controller Right F1612
- SummaFlex Pro with camera support for optical recognition to support the whole 'Print and Cut' workflow.
- Standard power requirements: 3 X 400V+N

### F1612 Electrical wiring options

FIELD CHANGE KIT 3x400+N TO 3x230V (3 PHASE)	500-9231	230,77
--	----------	--------

### F1612 Miscellaneous Options

FIELD UPGRADE: ADC RIGHT F1612 * requires: Pneumatic pack [500-9111] not included	500-9125	2 076,92
FIELD UPGRADE: ADC LEFT F1612 * requires: ADC RIGHT [500-9123] or [500-9125] not included	500-9126	1 984,62
BASE FOR SAFETYPOLE (SET OF 4)	500-9220	446,15
Hercules vacuum cleaner 3 kW	500-9345	2 600,00

### F1612 Media Handling Options

BASKET F1612	500-9120	753,85
Sturdy Folding EXTENTION TABLE - 180cm x 90cm	500-9121	753,85

### Software

UPGRADE BARCODE FOR SUMMAFLEX PRO	500-9503	1 523,08
-----------------------------------	----------	----------



## SUMMA Flatbed Cutting System

Description	Ref. Papyrus	€
<b>F1612 Modules</b>		
<b>DRAG MODULE</b>	<b>500-9300</b>	<b>1 523,08</b>
For table calibration, drag-knife cutting (up to 600gr) and pen drawing (1 module is standard delivered with the table). Includes: * Standard Drag knife Holder dia:1.5mm [391-332] * Drag knife 36° dia:1.5mm offset:0.45mm (1 knife) [5pc:391-358] * Fibre tip pen black (1 pen) [4pc:MP06BK]		
<b>TANGENTIAL MODULE</b>	<b>500-9310</b>	<b>4 600,00</b>
Heavy duty tangentially controlled module suitable for several tools. (see accessories)		
<b>ROUTER SYSTEM for F1612</b>	<b>500-9330</b>	<b>6 923,08</b>
includes: * Routing module(with brush system) * Hoses and Gantry * Electronic board including switch for vacuum cleaner * Kress Milling Motor * Collets: 3, 4, 6 and 8 mm * 4mm bit - up to 10 mm deep (1X) * Routing Mat [500-9333]		
<b>HF ROUTER SYSTEM for F1612</b>	<b>500-9372</b>	<b>19 230,77</b>
includes: * Routing module(with brush system) * Hoses and Gantry * Electronics including switch for vacuum cleaner * SycoTec Milling Motor * Collet: 6 mm * 4 mm bit - up to 12 mm deep (1X) * Routing Mat [500-9333]		
<b>ROTARY MODULE</b>	<b>500-9360</b>	<b>7 676,92</b>
includes: * 1 decagonal knife of 28mm		





## SUMMA Flatbed Cutting System

Description	Ref. Papyrus	€
<b>SUMMA F Series - Mains and Options</b>		
<b>F1330</b>	<b>F1330-02</b>	<b>63 061,54</b>
 <p>SUMMA F1330 : cutting table; working area 129x305cm includes:</p> <ul style="list-style-type: none"> <li>• Vacuum Pack: 1 Pump 2,3kW, sound absorber, switching valve</li> <li>• Conveyor System with 3 Pneumatic Media Clamps and Roll-support.</li> <li>• Safety Pack: Four pole laserbeam system</li> <li>• Camera system</li> <li>• Automatic Depth Controller Right F1612</li> <li>• SummaFlex Pro with camera support for optical recognition to support the whole 'Print and Cut' workflow.</li> <li>• Drag Module</li> <li>• Pneumatic Board</li> <li>• Standard power requirements: 3 X 400V+N</li> </ul>		
<b>F1330 Electrical wiring options</b>		
FACTORY INSTALLED 3X230V ( 3 PHASE ) - F1330	500-9237	0,00
<b>Installation Assistance (MANDATORY)</b>		
INSTALLATION ASSISTANCE FXX30 REGION 1	INST24R1	6 923,08
INSTALLATION ASSISTANCE FXX30 REGION 2	INST24R2	7 692,31
INSTALLATION ASSISTANCE FXX30 REGION 3	INST24R3	9 230,77
<b>F1330 Miscellaneous Options</b>		
KIT PUMP CONNECTION 12M (for F1330)	500-9165	507,69
KIT PUMP CONNECTION 25M (for F1330)	500-9166	907,69
BASE FOR SAFETYPOLE (SET OF 4)	500-9220	446,15
Hercules vacuum cleaner 3 kW	500-9345	2 600,00
<b>Fxx30 Automated Depth Control</b>		
FIELD UPGRADE: ADC RIGHT Fxx30	500-9129	2 076,92
FIELD UPGRADE: ADC LEFT Fxx30 * requires: ADC RIGHT [500-9127] or [500-9129] not included	500-9130	2 046,15
<b>Software</b>		
UPGRADE BARCODE FOR SUMMAFLEX PRO	500-9503	1 523,08



## SUMMA Flatbed Cutting System

Description	Ref. Papyrus	€
<b>F1330 Modules</b>		
<b>DRAG MODULE</b>	<b>500-9300</b>	<b>1 523,08</b>
For table calibration, drag-knife cutting (up to 600gr) and pen drawing (1 module is standard delivered with the table). Includes: * Standard Drag knife Holder dia:1.5mm [391-332] * Drag knife 36° dia:1.5mm offset:0.45mm (1 knife) [5pc:391-358] * Fibre tip pen black (1 pen) [4pc:MP06BK]		
<b>TANGENTIAL MODULE</b>	<b>500-9310</b>	<b>4 600,00</b>
Heavy duty tangentially controlled module suitable for several tools. (see accessories)		
<b>ROUTER SYSTEM for F1330</b>	<b>500-9357</b>	<b>8 000,00</b>
includes: * Routing module(with brush system) * Hoses and Gantry * Electronic board including switch for vacuum cleaner * Kress Milling Motor * Collets: 3, 4, 6 and 8mm * 4mm bit - up to 10 mm deep (1X) * Routing Mats [1 x 500-9336]		
<b>HF ROUTER SYSTEM for F1330</b>	<b>500-9371</b>	<b>20 307,69</b>
includes: * Routing module(with brush system) * Hoses and Gantry * Electronics including switch for vacuum cleaner * SycoTec Milling Motor * Collet: 6 mm * 4 mm bit - up to 12 mm deep (1X) * Routing Mats [1 x 500-9336]		
<b>ROTARY MODULE</b>	<b>500-9360</b>	<b>7 676,92</b>
includes: * 1 decagonal knife of 28mm		



## SUMMA Flatbed Cutting System

Description	Ref. Papyrus	€
-------------	-----------------	---

### SUMMA F Series - Mains and Options

<b>F 1832</b>	<b>F1832-22</b>	<b>78 446,15</b>
---------------	-----------------	------------------



SUMMA F1832 : Cutting table; working area 184x320cm

- Vacuum Pack: Pump 2 x 2,3kW, sound absorber, switching valve
- Conveyor System with 6 Pneumatic Media Clamps and Roll-support.
- Safety Pack: Four pole laserbeam system
- Camera system
- Drag Module
- Automatic Depth Controller Right
- SummaFlex Pro with camera support for optical recognition to support the whole 'Print and Cut' workflow.
- Standard power requirements: 3 X 400V+N

### F1832 Electrical wiring options

FACTORY INSTALLED 3X230V ( 3 PHASE ) - F1832 and F2630	500-9236	0,00
--	----------	------

### Installation Assistance (MANDATORY)

INSTALLATION ASSISTANCE FXX30 REGION 1	INST24R1	6 923,08
INSTALLATION ASSISTANCE FXX30 REGION 2	INST24R2	7 692,31
INSTALLATION ASSISTANCE FXX30 REGION 3	INST24R3	9 230,77

### F 1832 Miscellaneous Options

KIT PUMP CONNECTION 12M (for F1832 and F2630)	500-9165	923,08
KIT PUMP CONNECTION 25M (for F1832 and F2630)	500-9166	1 676,92
FIELD UPGRADE: ADC LEFT Fxx3x * requires: ADC RIGHT [500-9127] or [500-9129] not included		500-9126 2
046,15		
BASE FOR SAFETYPOLE (SET OF 4)	500-9220	446,15
Hercules vacuum cleaner 3 kW	500-9345	2 600,00

### Software

SUMMAFLEX PRO ROLL CUTTER EDITION (Includes barcode license)	500-9501C	3 061,54
UPGRADE BARCODE FOR SUMMAFLEX PRO	500-9503	1 523,08



## SUMMA Flatbed Cutting System

Description	Ref. Papyrus	€
<b>F 1832 Modules</b>		
<b>DRAG MODULE</b>	<b>500-9300</b>	<b>1 523,08</b>
For table calibration, drag-knife cutting (up to 600gr) and pen drawing (1 module is standard delivered with the table). Includes: * Standard Drag knife Holder dia:1.5mm [391-332] * Drag knife 36° dia:1.5mm offset:0.45mm (1 knife) [5pc:391-358] * Fibre tip pen black (1 pen) [4pc:MP06BK]		
<b>TANGENTIAL MODULE</b>	<b>500-9310</b>	<b>4 600,00</b>
Heavy duty tangentially controlled module suitable for several tools. (see accessories)		
<b>ROUTER SYSTEM for F1832</b>	<b>500-9354</b>	<b>8 230,77</b>
includes: * Routing module(with brush system) * Hoses and Gantry * Electronic board including switch for vacuum cleaner * Kress Milling Motor * Collets: 3, 4, 6 and 8 mm * 4mm bit - up to 10 mm deep (1X) * Routing Mat [500-9333]		
<b>HF ROUTER SYSTEM for F1832</b>	<b>500-9372</b>	<b>20 538,46</b>
includes: * Routing module(with brush system) * Hoses and Gantry * Electronics including switch for vacuum cleaner * SycoTec Milling Motor * Collet: 6 mm * 4 mm bit - up to 12 mm deep (1X) * Routing Mat [500-9333]		
<b>ROTARY MODULE</b>	<b>500-9360</b>	<b>7 676,92</b>
includes: * 1 decagonal knife of 28mm		



## SUMMA Flatbed Cutting System

Description	Ref. Papyrus	€
<b>SUMMA F Series - Mains and Options</b>		
<b>F2630</b>	<b>2630-02</b>	<b>89 215,38</b>
 <p>SUMMA F2630 : cutting table; working area 265x305cm includes:</p> <ul style="list-style-type: none"> <li>• Vacuum Pack: 2 Pumps 2,3kW, sound absorber, switching valve</li> <li>• Conveyor System with 6 Pneumatic Media Clamps and Roll-support.</li> <li>• Safety Pack: Four pole laserbeam system</li> <li>• Camera system</li> <li>• Drag Module</li> <li>• Pneumatic Board</li> <li>• Automatic Depth Controller Right F1612</li> <li>• SummaFlex Pro with camera support for optical recognition to support the whole 'Print and Cut' workflow.</li> <li>• Standard power requirements: 3 X 400V+N</li> </ul>		
<b>F2630 Electrical wiring options</b>		
FACTORY INSTALLED 3X230V ( 3 PHASE ) - F2630	500-9236	0,00
<b>Installation Assistance (MANDATORY)</b>		
INSTALLATION ASSISTANCE FXX30 REGION 1	INST24R1	6 923,08
INSTALLATION ASSISTANCE FXX30 REGION 2	INST24R2	7 692,31
INSTALLATION ASSISTANCE FXX30 REGION 3	INST24R3	9 230,77
<b>F2630 Miscellaneous Options</b>		
KIT PUMP CONNECTION 12M (for F2630)	500-9165	923,08
KIT PUMP CONNECTION 25M (for F2630)	500-9166	1 676,92
BASE FOR SAFETYPole (SET OF 4)	500-9220	446,15
Hercules vacuum cleaner 3 kW	500-9345	2 600,00
<b>Fxx30 Automated Depth Control</b>		
FIELD UPGRADE: ADC RIGHT Fxx30	500-9129	2 076,92
FIELD UPGRADE: ADC LEFT Fxx30 * requires: ADC RIGHT [500-9127] or [500-9129] not included	500-9130	2 046,15
<b>Software</b>		
UPGRADE BARCODE FOR SUMMAFLEX PRO	500-9503	1 523,08



## SUMMA Flatbed Cutting System

Description	Ref. Papyrus	€
<b>F2630 Modules</b>		
<b>DRAG MODULE</b>	<b>500-9300</b>	<b>1 523,08</b>
For table calibration, drag-knife cutting (up to 600gr) and pen drawing (1 module is standard delivered with the table). Includes: * Standard Drag knife Holder dia:1.5mm [391-332] * Drag knife 36° dia:1.5mm offset:0.45mm (1 knife) [5pc:391-358] * Fibre tip pen black (1 pen) [4pc:MP06BK]		
<b>TANGENTIAL MODULE</b>	<b>500-9310</b>	<b>4 600,00</b>
Heavy duty tangentially controlled module suitable for several tools. (see accessories)		
<b>ROUTER SYSTEM for F2630</b>	<b>500-9337</b>	<b>8 461,54</b>
includes: * Routing module(with brush system) * Hoses and Gantry * Electronic board including switch for vacuum cleaner * Kress Milling Motor * Collets: 3, 4, 6 and 8 mm * 4 mm bit - up to 10 mm deep (1X) * Routing Mats [2 x 500-9336]		
<b>HF ROUTER SYSTEM for F2630</b>	<b>500-9370</b>	<b>20 769,23</b>
includes: * Routing module(with brush system) * Hoses and Gantry * Electronics including switch for vacuum cleaner * SycoTec Milling Motor * Collet: 6 mm * 4 mm bit - up to 12 mm deep (1X) * Routing Mats [2 x 500-9336]		
<b>ROTARY MODULE</b>	<b>500-9360</b>	<b>7 676,92</b>
includes: * 1 decagonal knife of 28mm		



## SUMMA Flatbed Cutting System

Description	Ref. Papyrus	€
-------------	--------------	---

### SUMMA F Series - Consumables and Accessories

#### Mats and Belts

CONVEYOR BELT kit for F1612	500-9114	1 061,54
PROTECTIVE MAT for F1612 - 166cm x 170cm x 2,5mm	500-9115	446,15
CONVEYOR BELT kit for F1832	500-9355	1 984,62
PROTECTIVE MAT for F1832 - 189cm x 170cm x 2,5mm	500-9356	984,62
CONVEYOR BELT kit for F2630	500-9153	3 369,23
PROTECTIVE MATS for F2630 - ( 2 X ) 269cm x 170cm x 2,5mm	500-9154	1 369,23
CONVEYOR BELT kit for F1330	500-9163	1 523,08
PROTECTIVE MAT for F1330 - ( 2 X ) 134cm x 170cm x 2,5mm	500-9164	753,85
ROUTING MAT (1.54m) - 11,4m x 1.53m x 2mm	500-9333	446,15
ROUTING MAT (1.3m) - 11,4m x 1.3m x 2mm	500-9336	415,38

#### Consumables and Accessories for Drag Module

DRAG KNIFE 60' DIA:1.5MM OFFSET:0.5 MM	391-231	44,62
STANDARD DRAG KNIFE HOLDER DIA:1.5 MM	391-232	115,38
DRAG KNIFE 55' DIA:2MM OFFSET:0.9 MM (5X)	391-358	200,00
STANDARD DRAG KNIFE 36' DIA:1.5 MM OFFSET:0.45 MM (5X)	391-360	161,54
DRAG KNIFE HOLDER DIA:2 MM (COPPER)	391-363	136,92
ROLLER BALL BLACK (5 PIECES)	395-430	115,38
UNIVERSAL PENHOLDERS D-HEAD	395-434	230,77
FIBRE TIP BLACK PENS (4)	MP06BK	110,77

#### Tools for Tangential Module

### Kiss-Cut Tool

With mechanically-controlled knife pressure, this tool is specifically designed for kiss-cutting material down to its liner up to 1.2 mm thick. This tool also includes an adjustable nose piece for precise depth control.



Ideal for cutting



1. Paper < 200 gr
2. Adhesive vinyl / Sandblast material
3. Window film
4. Magnetic material
5. Adhesive PVC banner vinyl

Blades



390-534 - Tangential Knife 36°  
Max cutting thickness - 0.25 mm



390-550 - Tangential Knife 60°  
Max cutting thickness - 1.2 mm



390-551 - Tangential Double Tip Knife 36°  
Max cutting thickness - 0.25 mm



390-560 - Tangential Knife 45° wedge 40/25°  
Max cutting thickness - 1 mm

#### KISS CUTTING TOOL

includes:

- \* springs: Up to 120 (1x), 650 (1x) and 1800gr (1x)
- \* standard nose piece (395-348)
- \* standard tangential knife (includes 1 knife) [set of 5: 390-534]

500-9311 692,31

## SUMMA Flatbed Cutting System

Description	Ref. Papyrus	€
-------------	--------------	---

### SUMMA F Series - Consumables and Accessories

#### Tools for Tangential Module

### Single Edge Cutout Tool

The Single Edge Cutout Tool is designed for detailed cutting through material up to 6 mm thick. A spring-loaded gliding disk allows cutting of very precise details and can be fixed at a set depth.



- Ideal for cutting**
1. Paper < 200 gr
  2. Cardboard 300-500 gr
  3. Adhesive vinyl
  4. Hard foamboard <= 2 mm
  5. Polypropelene <= 1.2 mm
  6. Polycarbonate <= 0.6 mm
  7. Adhesive PVC banner vinyl
  8. Magnetic material



SINGLE EDGE CUTOUT TOOL - with gliding disk includes:

- \* Single Edge Cutout blade 65° (1x) [500-9801]

500-9312

276,92

### Double Edge Cutout Tool

The Double Edge Cutout Tool ensures minimal wear when cutting through rigid material up to 5 mm thick.

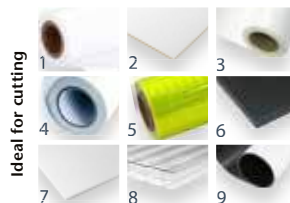

- Ideal for cutting**
1. Paper < 200 gr
  2. Cardboard 300-500 gr
  3. Adhesive vinyl
  4. Adhesive PVC banner vinyl
  5. Reflective sheeting
  6. Hard foamboard <= 1.2 mm
  7. Polypropelene <= 1.2 mm
  8. Polycarbonate <= 0.6 mm
  9. Magnetic material

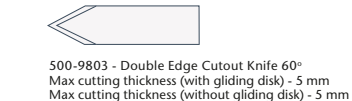
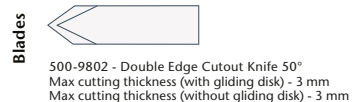

Again, a spring-loaded gliding disk allows cutting of very precise details and can be fixed at a set depth.

DOUBLE EDGE CUTOUT TOOL - with gliding disk includes:

- \* Double Edge Cutout blade 50° (1x) [500-9802]
- \* Double Edge Cutout blade 60° (1x) [500-9803]

500-9313

292,31

### Heavy Duty Cutout Tool

The Heavy Duty Cutout Tool is suitable for cutting through thicker material up to 15 mm thick.

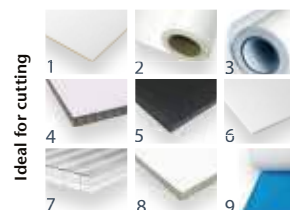

- Ideal for cutting**
1. Cardboard 300-500 gr
  2. Adhesive vinyl
  3. Adhesive PVC banner vinyl
  4. Corrugated plastic <= 5 mm
  5. Hard foamboard <= 1.2 mm
  6. Polypropelene <= 1.2 mm
  7. Polycarbonate <= 0.6 mm
  8. Foamboard with paper <= 5 mm
  9. Varnish blankets



HEAVY DUTY CUTOUT TOOL includes:

- \* Heavy Duty Cutout blade 45°/90° (1x) [500-9807]

500-9314

292,31



# SUMMA Flatbed Cutting System

Description	Ref. Papyrus	€
-------------	--------------	---

## SUMMA F Series - Consumables and Accessories

### Tools for Tangential Module

#### Electronic Oscillating Tool

Ideal for cutting soft and medium density materials such as corrugated board and foam up to 18 mm thick. The Electronic Oscillating Tool is driven by an electric motor, producing up to 12,000 rpm and moves a knife up and down over a stroke of 1 mm.



Ideal for cutting



1. Corrugated B-C-E Flute (1.5-4 mm)
2. Foamboard with paper <= 10 mm
3. Foamboard with paper > 5 mm
4. Honeycomb board < 10 mm
5. Gasket

Blades



500-9800 - EOT L25 Knife 65°  
Max cutting thickness (with gliding disk) - 5 mm  
Max cutting thickness (without gliding disk) - 5 mm



500-9810 - EOT L25 Knife 65° - 80°  
Max cutting thickness (with gliding disk) - 5 mm  
Max cutting thickness (without gliding disk) - 11 mm



500-9811 - EOT L25 Knife 65° - 85°  
Max cutting thickness (with gliding disk) - 5 mm  
Max cutting thickness (without gliding disk) - 11 mm



500-9814 - EOT L38 Knife 45° - 86°  
Max cutting thickness (with gliding disk) - 18 mm  
Max cutting thickness (without gliding disk) - 24 mm



500-9812 - EOT L28 Knife 65° - 85°  
Max cutting thickness (with gliding disk) - 8 mm  
Max cutting thickness (without gliding disk) - 14 mm



500-9815 - EOT L33 Knife 45° - 85°  
Max cutting thickness (with gliding disk) - 13 mm  
Max cutting thickness (without gliding disk) - 19 mm



500-9813 - EOT L25 Knife 0° - 75°  
Max cutting thickness (with gliding disk) - 5 mm  
Max cutting thickness (without gliding disk) - 6 mm

#### ELECTRONIC OSCILLATING TOOL

- \* Stroke : 1 mm
- \* 1 x KNIFE OT L25 65°-85° [500-9811]
- \* Requires: regular service maintenance
- \* Recommended: set of two

500-9320 4 600,00

#### Creasing Tools

Several Creasing Wheels, designed in different depths and radius sizes, are available for creasing and scoring paper, cartons, polypropylene and PVC material.



1. 500-9325  
Creasing Tool D25 R3 W8  
corrugated C-B-C Flute (4-7 mm)
2. 500-9326  
Creasing Tool D25 R1.5 W8  
corrugated B-C Flute (3-4 mm)
3. 500-9327  
Creasing Tool D25 R0.75 W1.5  
corrugated E-B Flute (1.5-3 mm)

4. 500-9328  
Creasing Tool D15 R0.35 W0.7 - 2pt  
cardboard 300 - 500 gr m<sup>2</sup> / corrugated E Flute (1.5 mm)
5. 500-9329  
Creasing Tool D15 R0.17 W0.35 - 1pt  
polypropylene sheets <= 1.2 mm

- CREASING TOOL D25 R3 W8 H7
- CREASING TOOL D25 R1.5 W8 H5.5
- CREASING TOOL D25 R0.75 W1.5 H1.5
- CREASING TOOL D15 R0.35 W0.7 H1 - 2PT
- CREASING TOOL D15 H1.5 - 1PT

500-9325 230,77  
500-9326 230,77  
500-9327 230,77  
500-9328 230,77  
500-9329 230,77

## SUMMA Flatbed Cutting System

Description	Ref. Papyrus	€
-------------	--------------	---

### SUMMA F Series - Consumables and Accessories

#### Tools for Tangential Module

### V-Cut Tools

The V-Cut Tools are available in 5 angles and are designed to cut a V-shaped groove in rigid sandwich and foam composite boards up to 27 mm thick, depending on the material's density.

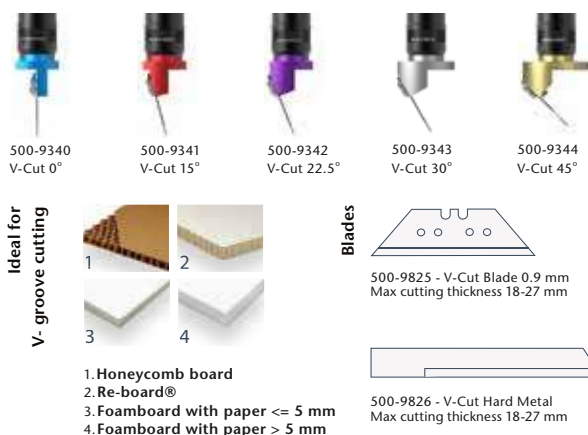

#### V-CUT TOOL 0°

includes:

- \* 1 set of 5 V-Cut blades 0.9 mm [500-9825]
- \* 1 hard metal v-cut blade [500-9826]

500-9340

446,15

#### V-CUT TOOL 15°

includes:

- \* 1 set of 5 V-Cut blades 0.9 mm [500-9825]
- \* 1 hard metal v-cut blade [500-9826]

500-9341

446,15

#### V-CUT TOOL 22.5°

includes:

- \* 1 set of 5 V-Cut blades 0.9 mm [500-9825]
- \* 1 hard metal v-cut blade [500-9826]

500-9342

446,15

#### V-CUT TOOL 30°

includes:

- \* 1 set of 5 V-Cut blades 0.9 mm [500-9825]
- \* 1 hard metal v-cut blade [500-9826]

500-9343

446,15

#### V-CUT TOOL 45°

includes:

- \* 1 set of 5 V-Cut blades 0.9mm [500-9825]
- \* 1 hard metal V-Cut blade [500-9826]

500-9344

446,15



## SUMMA Flatbed Cutting System

Description	Ref. Papyrus	€
-------------	--------------	---

### SUMMA F Series - Consumables and Accessories

#### Tools for Tangential Module

### Pneumatic Oscillating Tool

The Pneumatic Oscillating Tool, powered by compressed air, moves a knife up and down over a stroke of 8 mm.

The robust construction of the tool makes it suitable to cut thick material, such as honeycomb board, corrugated board and foam board.



Ideal for cutting

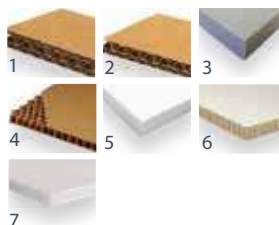

1. Triple walled cardboard
2. Double walled cardboard
3. Packaging Foam
4. Honeycomb board  $\geq 10$  mm
5. Foamboard with paper  $> 5$  mm
6. Re-board®
7. Foamboard with plastic

Blades



500-9830 - POT Knife Flat Point L20 T0.63  
Max cutting thickness - 18mm



500-9831 - POT Knife Flat Point L27 T0.63  
Max cutting thickness - 25mm

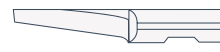

500-9832 - POT Knife Flat Point L20 T1.5  
Max cutting thickness - 18mm



500-9833 - POT Knife Flat Point L27 T 1.0  
Max cutting thickness - 25mm

#### PNEUMATIC OSCILLATING TOOL

\* includes: 1 x KNIFE POT Flat Point L20 T0.63

\* Requires: service maintenance

\* Requires: Dry and high volume compressed air.

500-9350

3 830,77

#### Consumables and Accessories for Tangential Module

STANDARD TANG. KNIFE 36' (5X)	390-534	261,54
TANG KNIFE 60' SANDBLAST	390-550	61,54
TANG DOUBLE TIP KNIFE 36'	390-551	83,08
KNIFE INSTALL TOOL	390-553	13,85
KNIFE OT L25 / 65°-80° - up to 11 mm thick material - tool holder: [500-9320]	500-9810	43,08
KNIFE OT L25 / 65°-85° - up to 11 mm thick material - tool holder: [500-9320]	500-9811	43,08
KNIFE OT L28 / 65°-85° - up to 14 mm thick material - tool holder: [500-9320]	500-9812	43,08
KNIFE OT L25 / 0°-65° - up to 6 mm thick material - tool holder: [500-9320]	500-9813	43,08

#### Consumables and Accessories for Routing Module

3 MM COLLET FOR 1050 FME	500-0241	69,23
4 MM COLLET FOR 1050 FME	500-0242	69,23
6 MM COLLET FOR 1050 FME	500-0243	69,23
8 MM COLLET FOR 1050 FME	500-0244	69,23
BIT D3/3 L60/10 1FL UC (3X)	500-9850	147,69
BIT D4/4 L50/12 1FL UC (3X)	500-9852	120,00
BIT D6/3 L50/06 MP 1FL UC (3X)	500-9854	110,77
BIT D6/4 L50/12 MP 1FL UC (3X)	500-9856	110,77
BIT D6/6 L50/12 MP 1FL UC BAL (3X)	500-9857	129,23
BIT D6/6 L58/22 MP 1FL UC BAL (3X)	500-9858	129,23

#### Consumables and Accessories for Rotary Module

DECAGONAL KNIFE D25 (3X)	500-0241	167,69
DECAGONAL KNIFE D28 (3X)	500-0242	167,69
DECAGONAL KNIFE D32 (3X)	500-0243	167,69

## ROLL-X Flatbed Applicator

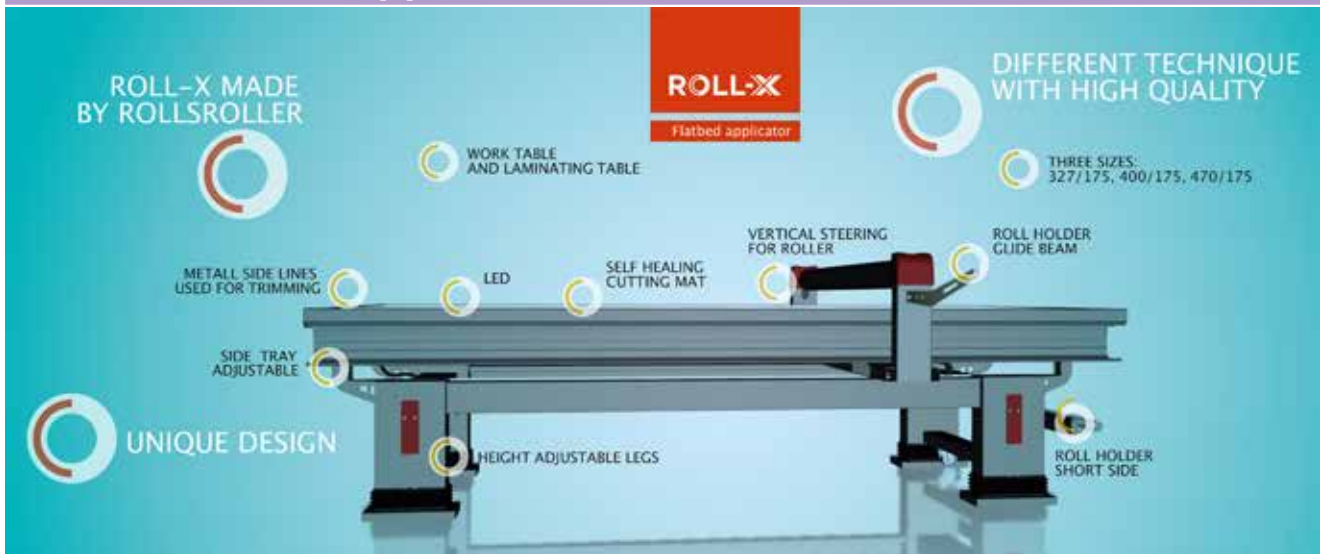

Description	Ref. Papyrus	€
<b>Roll-X® GO</b> Flatbed Applicator with: tempered glass bed, self healing cutting mat, side pockets, media holder, Stop static kit, Casters.		
<b>RX GO 470/175</b>		<b>13 900,00</b>
Bed length		4700 mm.
Bed width		1750 mm.
Length of working area		4300 mm.
Width of working area/roller width		1650 mm.
Work height flatbed		850 -1070 mm.
Max. thickness of substrate		85 mm.
<b>RX GO 400/175</b>		<b>12 900,00</b>
Bed length		4000 mm.
Bed width		1750 mm.
Length of working area		3600 mm.
Width of working area/roller width		1650 mm.
Work height flatbed		850 -1070 mm.
Max. thickness of substrate		85 mm.
<b>RX GO 327/175</b>		<b>11 900,00</b>
Bed length		3270 mm.
Bed width		1750 mm.
Length of working area		2870 mm.
Width of working area/roller width		1650 mm.
Work height flatbed		850 -1070 mm.
Max. thickness of substrate		85 mm.

## ROLL-X Flatbed Applicator

Description	Ref. Papyrus	€
<b>Roll-X® Professional</b>		
Flatbed Applicator with: Led illuminated tempered glass bed, electrical height adjustment, self healing cutting mat, side pockets, media holder, Stop static kit, Casters.		
<b>RX Professional 470/175</b>		<b>17 400,00</b>
Bed length		4700 mm.
Bed width		1750 mm.
Length of working area		4300 mm.
Width of working area/roller width		1650 mm.
Work height flatbed		850 -1070 mm.
Max. thickness of substrate		85 mm.
<b>RX Professional 400/175</b>		<b>16 400,00</b>
Bed length		4000 mm.
Bed width		1750 mm.
Length of working area		3600 mm.
Width of working area/roller width		1650 mm.
Work height flatbed		850 -1070 mm.
Max. thickness of substrate		85 mm.
<b>RX Professional 327/175</b>		<b>15 400,00</b>
Bed length		3270 mm.
Bed width		1750 mm.
Length of working area		2870 mm.
Width of working area/roller width		1650 mm.
Work height flatbed		850 -1070 mm.
Max. thickness of substrate		85 mm.
<b>ROLL-X ACCESSORIES</b>		
EXC 230 With double shock system and back stop function	10544	954,62
EXC 430 With double shock system and back stop function	10546	1 066,92
Contact cleaner hand roller 30 - Including automatic cleaning station	71029	673,85
Air blow gun	70962	168,46
Roll-X long life compressor	71491	790,00
Long reach cutter 60 mm	10493	64,00
Long reach cutter 90 mm	10494	74,00
Cutting mat 3 270 x 1 680 mm	10071	363,00
Cutting mat 4 000 x 1 680 mm	10237	444,00
Cutting mat 4 700 x 1 680 mm	10301	522,00
Led Option For Roll-X® Advantage		500,00
Electrical Height adjustment Option for Roll-X® Advantage		2 000,00
Extendable shaft 1000 mm - 1600 mm - Straight adapter for roller 300mm	10443	123,54
Roll cradle for side tray, 2pcs	10098	280,77





## KALA COLD LAMINATORS

Description	Ref. Papyrus	€
<b>STARTER Range</b> Budget cold laminator, providing highly professional results.		
<b>STARTER 1080 - 108 cm (43 inches) incl. Stand</b>	<b>T1080101</b>	<b>3 411,33</b>
 <p>Maximum thickness print + board: 50 mm. Maximum working width: 1179 mm. Diameter of the rollers: 74 mm. Nb of self blocking shafts supplied: 3 Adjustable speed m/mn: from 1 m to 3,60 m Power W: 190W Weight of the machine on its stand: 91 kg. Working table height: 99,5 cm.</p>		
Maximum working width	TG1080	133,88
Rewinding unit for laminated prints for T 1080	ET1080	758,63
Antistatic wire w/ magnets for 1080	MP441840	68,43
<b>STARTER 1400 - 140 cm (55 inches)incl. Stand</b>	<b>T1400101</b>	<b>3 827,83</b>
 <p>Maximum thickness print + board: 50 mm. Maximum working width: 1482 mm. Diameter of the rollers: 76 mm. Nb of self blocking shafts supplied: 3 Adjustable speed m/mn: from 1 m to 3,60 m Power W: 190W Weight of the machine on its stand: 119 kg. Working table height: 99,5 cm.</p>		
Optional feeding bar and print roll holder for T 1400	TG1400	143,80
Rewinding unit for laminated prints for T 1400	ET1400	778,47
Antistatic wire w/ magnets for 1400/1650	MP601840	78,35
40°C Heating kit for Starter 1400.	MAJC1400001	823,08
<b>STARTER 1600 - 160 cm (63 inches)incl. Stand</b>	<b>T1600101</b>	<b>4 343,50</b>
 <p>Maximum thickness print + board: 50 mm. Maximum working width: 1654 mm. Diameter of the rollers: 76 mm. Nb of self blocking shafts supplied: 3 Adjustable speed m/mn: from 1 m to 3,60 m Power W: 190W Weight of the machine on its stand: 129 kg. Working table height: 99,5 cm.</p>		
Rewinding unit for laminated prints for T 1600	ET1600	793,33
Antistatic wire w/ magnets for 1400/1650	MP601840	78,35
40°C Heating kit for Starter 1600.	MAJC1600001	823,08



## KALA COLD LAMINATORS

Description	Ref. Papyrus	€
<b>STARTER WITH UPPER HEATED ROLLER AT 40°C</b>		
Budget cold laminator, providing highly professional results.		
<b>STARTER 1080 UH - 108 cm (43 inches) incl. Stand</b>	<b>T1080111</b>	<b>4 239,38</b>
	Maximum thickness print + board: 50 mm. Maximum working width: 1179 mm. Diameter of the rollers: 74 mm. Nb of self blocking shafts supplied: 3 Adjustable speed m/mn: from 1 m to 3,60 m Power W: 190W Weight of the machine on its stand: 91 kg. Working table height: 99,5 cm.	
Optional feeding bar and print roll holder for T 1080	TG1080	133,88
Rewinding unit for laminated prints for T 1080	ET1080	758,63
Antistatic wire w/ magnets for 1080	MP441840	68,43
<b>STARTER 1400 UH - 140 cm (55 inches)incl. Stand</b>	<b>T1400111</b>	<b>4 770,63</b>
	Maximum thickness print + board: 50 mm. Maximum working width: 1482 mm. Diameter of the rollers: 76 mm. Nb of self blocking shafts supplied: 3 Adjustable speed m/mn: from 1 m to 3,60 m Power W: 190W Weight of the machine on its stand: 119 kg. Working table height: 99,5 cm.	
Optional feeding bar and print roll holder for T 1400	TG1400	143,80
Rewinding unit for laminated prints for T 1400	ET1400	778,47
Antistatic wire w/ magnets for 1400/1650	MP601840	78,35
<b>STARTER 1600 UH - 160 cm (63 inches)incl. Stand</b>	<b>T1600111</b>	<b>5 301,88</b>
	Maximum thickness print + board: 50 mm. Maximum working width: 1654 mm. Diameter of the rollers: 76 mm. Nb of self blocking shafts supplied: 3 Adjustable speed m/mn: from 1 m to 3,60 m Power W: 190W Weight of the machine on its stand: 129 kg. Working table height: 99,5 cm.	
Optional feeding bar and print roll holder for T 1600	TG1600	153,72
Rewinding unit for laminated prints for T 1600	ET1600	793,33
Antistatic wire w/ magnets for 1400/1650	MP601840	78,35





## KALA COLD LAMINATORS

Description	Ref. Papyrus	€
<b>BALTIC Range</b> Heavy duty cold laminators for printers aiming to integrate finishing for a lower budget.		
<b>BALTIC 1400 - 1,40 m - 55" (delivered with its stand)</b>	<b>C1400001</b>	<b>5 640,00</b>



1,40 m - 55" Ø 76 mm/3" - Baltic 1400	AXB140076	133,17
Optional rewinding system width 1400 mm - 55"	E1400002	927,92
Antistatic wire w/ magnets for 1400/1650	MP601840	73,67

## KALA COLD LAMINATORS WITH TOP HEATED ROLLER

<b>MISTRAL Range</b> High quality, high speed cold laminators with upper heated roller and integrated "roll to roll" operation.		
<b>MISTRAL 1650 - 1,65 m - 65"</b>	<b>M1650001</b>	<b>8 576,67</b>



Shaft 1,65 m - 65" Ø 76 mm/3" - Mistral, Arkane 1650	AX165076	136,00
Antistatic wire w/ magnets for 1650	MP601840	78,35
LED lighting option for Mistral 1650	MP601820	267,05
Online cutting accessory for Mistral 1650	SDL1650 001	736,67
Extra blade holder for SDL 1650, set of 2 holders	MP601580	69,42





## KALA COLD LAMINATORS WITH TOP HEATED ROLLER

Description	Ref. Papyrus	€
<b>MISTRAL Range</b> High quality, high speed cold laminators with upper heated roller and integrated "roll to roll" operation.		
<b>MISTRAL 2100 - 2,10 m - 83"</b>	<b>M2100011</b>	<b>12 466,67</b>



Shaft 2,10 m - 83" Ø 76 mm/3" - Mistral 2100	AX210076	177,08
Antistatic wire w/ magnets for 2100	MP621840	87,83
LED lighting option for Mistral 2100	MP621820	285,47

### KALA ARKANE Range

High quality, high speed hybrid laminator with upper high temperature heated roller, for specific applications.

<b>Arkane 1650 - 1,65 m - 65"</b>	<b>P1650001</b>	<b>9 392,83</b>
-----------------------------------	-----------------	-----------------



Shaft 1,65 m - 65" Ø 76 mm/3" - Mistral, Arkane 1650	AX165076	136,00
Antistatic wire w/ magnets for 1650	MP601840	78,35
LED lighting option for Mistral 1650	MP601820	267,05
Online cutting accessory for Mistral 1650	SDL1650 001	736,67
Extra blade holder for SDL 1650, set of 2 holders	MP601580	69,42



## KALA HOT and COLD LAMINATORS

Description	Ref. Papyrus	€
<b>ARKANE Rang</b> High quality, high speed hybrid laminator with two high temperature heated roller, for specific applications.		
Arkane 1650 - 1,65 m - 65" Arkane 1650 D-65 m 65" with double heating	P1650004	10 157,82



Shaft 1,65 m - 65" Ø 76 mm/3" - Mistral, Arkane 1650	AX165076	136,00
Antistatic wire w/ magnets for 1650	MP601840	78,35
LED lighting option for Mistral 1650	MP601820	267,05
Online cutting accessory for Mistral 1650	SDL1650 001	736,67
Extra blade holder for SDL 1650, set of 2 holders	MP601580	69,42

**SIROCCO Medium Range.**  
Same temperature adjustment for top and bottom rollers.

<b>SIROCCO 1080 - 1,08 m - 42,5"</b>	<b>S1080002</b>	<b>5 525,00</b>
--------------------------------------	-----------------	-----------------



Optional stand for SIROCCO 1080	ST1080V2	545,42
Self blocking shaft 1,08m-42,5" Ø76 mm/3" - S 1080	AX108076	110,50
Electric rewinding system width 1080 mm - 42,5"	E1080002	899,58

<b>SIROCCO 1600 - 1,60 m - 63"</b>	<b>S1600002</b>	<b>9 243,75</b>
------------------------------------	-----------------	-----------------



Self blocking shaft 1,60 m - 63" Ø 76 mm/3"	AX160076	136,00
Electric rewinding system width 1600 mm - 63" *	E1600002	927,92
Antistatic wire w/ magnets for 1600	MP601840	78,35



## KALA HOT and COLD LAMINATORS

Description	Ref. Papyrus	€
<b>Atlantic Range</b> For intensive uses. Rollers temperature can be adjusted independently.		
<b>ATLANTIC 1080 - 1,08 m - 42,5"</b>	<b>A1080002</b>	<b>8 518,42</b>



Self blocking shaft 1,08m-42,5" Ø76 mm/3" - S 1080	AX108076	110,50
Electric rewinding system width 1080 mm - 42,5"	E1080002	899,58
<b>ATLANTIC 1650 - 1,60 m - 63"</b>	<b>A1080002</b>	<b>15 285,00</b>



Shaft 1,65 m - 65" Ø 76 mm/3" - Mistral, Arkane 1650	AX165076	136,00
Antistatic wire w/ magnets for 1650	MP601840	78,35
LED lighting option for Mistral 1650	MP601820	267,05



## ACCESSORIES AND OPTION FOR LAMINATORS

Description	Ref. Papyrus	€
<b>Accessories</b>		
Roller cleaning rubber (40 x 40 x 50 mm)	GOMME	12,75
Magnetic safety cutter (as delivered with laminators)	CUTTER	9,92
<b>Waste paper</b>		
80g for single side lamination when using a film wider than prints, to prevent the film to stick onto the lower roller.		
Internal Ø 76 mm / 3" - 107 cm X 100 m	301055	54,60
Internal Ø 76 mm / 3" - 140 cm X 100 m	301056	62,95
Internal Ø 76 mm / 3" - 159 cm X 100 m	301057	74,32

## NEOLT

### NEOLT Trimmers

Description	Ref. Papyrus	€
<b>Electro Power Trim Plus Range</b>		
Electric trimmer with rotating blade in hardened steel • retrieval tray • fluorescent wire • movable guide • adjustable feet		



<b>Electro Power Trim Plus145</b>	<b>P 932</b>	<b>2 279,00</b>
145 CM Width • with stand, lamp and containment bracket		
<b>Electro Power Trim Plus 165</b>	<b>P 933</b>	<b>2 436,00</b>
165 CM Width • with stand, lamp and containment bracket		
<b>Electro Power Trim Plus 210</b>	<b>P 937</b>	<b>2 750,00</b>
210 CM Width • with stand, lamp and containment bracket		
<b>Electro Power Trim Plus 250</b>	<b>P 938</b>	<b>3 143,00</b>
210 CM Width • with stand, lamp and containment bracket		

## KEENCUT cutting machines

SteelTrak Vertical Cutter Range Tool. Turn and lock ready mounted tools • Total dust free operation • 5 year comprehensive guarantee • Can cut DiBond (Up to 4 mm), Forex (Up to 13 mm), Plexiglass (Up to 6 mm), Cast Acrylic (Up to 6mm) • Optional V cut Tool.



<b>SteelTrak 165 cm</b>		<b>ST165</b>	<b>3 221,40</b>
Cutting height: 165 cm - Width Support: 213 cm			
<b>SteelTrak 210 cm</b>		<b>88208024</b>	<b>3 741,15</b>
Cutting height: 210 cm - Width Support: 213 cm			
<b>SteelTrak 250 cm</b>		<b>ST250</b>	<b>4 521,30</b>
Cutting height: 250 cm - Width Support: 222 cm			
<b>Accessories for Steeltrak</b>			
Stand for SteelTraK 165	88208027	FSK160	217,35
Stand for SteelTraK 210	88208030	FSK210	310,80
Stand for SteelTraK 250	88208031	FSK250	570,15
Glass cutting kit 165cm, inc.1 glass cutting wheel CA50-015	88208037	STGLC	153,30

Description	Ref. Papyrus	€
-------------	-----------------	---

## KEENCUT cutting machines

### Blades and cutting wheels for Steeltrak

Aluminum sheet cutting head	88208039	STALC	129,15
Replacement aluminum cutting wheel set	88208044	STALW	70,35
Composite, Dibond, MDF cutting head	88208045	STCOC	129,15
Replacement composite cutting wheel set	88208047	STCOW	70,17
TC glass cutting wheel	88208054	CA50-015	16,80
Medium duty utility blades (100's)	88208056	CA50-019	15,75
CR 80 blades (harder) (100's)	88208069	CA50-010	45,15

### SteelTraK V-Grooving tools - 90° angle

V-Groover 2 mm	88208082	STVG2	172,20
V-Groover 3 mm	88208085	STVG3	172,20
V-Groover 4 mm	88208086	STVG4	172,20
V-Groover 5 mm	88208089	STVG5	172,20
V-Groover 6 mm	88208090	STVG6	172,20

## KeenCut Cutter Bars

EVOLUTION - Cutter bar to be installed on a table or a bench • For cutting Rigid, Seli-Rigid and flexible Médias • The box includes 2x Vertical Graphik Blade Holder (VABHG), 1x Vertical Medium Duty Blade Holder (VABHML), 1x Vertical Circular Blade Holder (VABHC), 1 Cutting strip EVOTCS, 25 graphik blades, 1 circular blade and 100's of medium duty blades



Cutter bar to be installed on a table or a bench • For cutting Rigid, Seli-Rigid and flexible Médias • The box includes 2x Vertical Graphik Blade Holder (VABHG), 1x Vertical Medium Duty Blade Holder (VABHML), 1x Vertical Circular Blade Holder (VABHC), 1 Cutting strip EVOTCS, 25 graphik blades, 1 circular blade and 100's of medium duty blades

<b>Evolution 2160</b>	<b>EV2160</b>	<b>1 164,95</b>
Cutting Width Support: 1,6 m - 64"		
<b>Evolution 2210</b>	<b>EV2210</b>	<b>1 272,60</b>
Cutting Width Support: 2,1 m - 104"		
<b>Evolution 2260</b>	<b>EV2260</b>	<b>1 424,85</b>
Cutting Width Support: 2,6 m - 104"		
<b>Evolution 2310</b>	<b>EV2310</b>	<b>1 572,90</b>
Cutting Width Support: 3,1 m - 124"		
<b>Evolution 2360</b>	<b>EV2360</b>	<b>1 682,10</b>
Cutting Width Support: 3,6 m - 144"		

## SEFA Heat presses

Description	Ref. Papyrus	€
<b>SEFA Chromaluxe Compatible Press</b>		
<b>Rotex Air Pro XL: Automatic Closing, opening and rotation • 1 Heating Zone</b>	<b>Rotex Air Pro X</b>	<b>3 788,00</b>



Plate Dimensions: 45 x 55 cm.  
 Max Temp: 220 °C  
 Pressure: 592 gr/cm<sup>2</sup>  
 Energy: 3200 W • 14 A • 240 V Single Phase  
 Weight: 115 KG  
 Number of heat plate: 1 plate  
 Max Product Thickness: 21 mm

**SLIDE 865: Automatic Closing and opening • 2 Heating Zones**

**SLIDE 865**

**6 608,00**



Plate Dimensions: 85 x 65 cm.  
 Max Temp: 230 °C  
 Pressure: 453 gr/cm<sup>2</sup>  
 Energy: 6000 W • 28 A • 240 V Single Phase  
 Weight: 261 KG  
 Number of heat plate: 1 plate  
 Max Product Thickness: 45 mm

**SLIDE 1285: Automatic Closing and opening • 2 Heating Zones**

**SLIDE 1285**

**10 597,00**



Plate Dimensions: 125 x 85 cm.  
 Max Temp: 230 °C  
 Pressure: 386 gr/cm<sup>2</sup>  
 Energy: 12000 W • 20 A • 400 V 3- Phases  
 Weight: 419 KG  
 Number of heat plate: 1 plate  
 Max Product Thickness: 45 mm

**Subli 1510+: Double motorized drawer plates • 2 Heating Zones**

**SLIDE 1510+**

**19 465,00**



Plate Dimensions: 157 x 107 cm.  
 Max Temp: 220 °C  
 Pressure: 296 gr/cm<sup>2</sup>  
 Energy: 20250 W • 32 A • 400 V 3- Phases  
 Weight: 1000 KG  
 Number of heat plate: 2 plates - Specific electronics to able sublimation on rigid substrates and textiles  
 Max Product Thickness: 45 mm



## SEFA Heat presses

Description	Ref. Papyrus	€
-------------	-----------------	---

### SEFA Chromaluxe Compatible Press

SubliMax 1812: Double motorized drawer plates • 4 Heating Zones	SUBLIMAX 1812	26 970,00
---	---------------	-----------



Plate Dimensions: 180 x 120 cm.  
 Max Temp: 220 °C  
 Pressure: 378 gr/cm<sup>2</sup>  
 Energy: 30250 W • 46 A • 400 V 3- Phases  
 Weight: 1394 KG  
 Number of heat plate: 2 plates - Specific electronics to able sublimation on rigid substrates and textiles  
 Max Product Thickness: 45 mm

SubliMax 2513: Double motorized drawer plates • 4 Heating Zones	SUBLIMAX 2513	43 889,00
---	---------------	-----------



Plate Dimensions: 255 x 130 cm.  
 Max Temp: 220 °C  
 Pressure: 378 gr/cm<sup>2</sup>  
 Energy: 35000 W • 56 A • 400 V 3- Phases  
 Weight: 2180 KG  
 Number of heat plate: 2 plates - Specific electronics to able sublimation on rigid substrates and textiles  
 Max Product Thickness: 45 mm

## SEFA compressors

Description	Ref. Papyrus	€
-------------	-----------------	---

Comp-74	Comp-074	1 330,00
---------	----------	----------



Sound: 42 dB(A)  
 Tank: 24 L.  
 Air Flow: 74 L./min.  
 Dimensions: 80 x 39 x 65 cm.  
 Weight: 46 Kg



## SEFA compressors

Description	Ref. Papyrus	€
<b>Comp-111</b>	<b>Comp-111</b>	<b>2 116,00</b>



Sound: 40 dB(A)  
 Tank: 50 L.  
 Air Flow: 111 L./min.  
 Dimensions: 91 x 46 x 67 cm.  
 Weight: 73 Kg

<b>Comp-240</b>	<b>Comp-240</b>	<b>2 295,00</b>
-----------------	-----------------	-----------------



Sound: 40 dB(A)  
 Tank: 50 L.  
 Air Flow: 240 L./min.  
 Dimensions: 114 x 38 x 76 cm.  
 Weight: 90 Kg

<b>Comp-300</b>	<b>Comp-300</b>	<b>5 498,00</b>
-----------------	-----------------	-----------------



Sound: 40 dB(A)  
 Tank: 150 L.  
 Air Flow: 300 L./min.  
 Dimensions: 127 x 53 x 87 cm.  
 Weight: 129 Kg

### SEFA Accessories

SEFA TABL-98 Lite Support table for Rotex Air Lite	88270452	TAB-98-LITE	318,00
SEFA TABL-98/R Support table with castors for Slide models	88270452	TABL-98/R	648,00
Nomex sheet for Slide 865	88270455	TOI-N865	162,00
Nomex sheet for Slide 1285	88270456	TOI-N1285	182,00
Exhausting system for SUBLI, SUBLIMAX and SUBLIMAXI	88270457	ASP-Subli	524,00
Chromaluxe Heat Press Protection Paper 1,67 m	88275578	YS2726	249,87
Chromaluxe Endura Roll 1,5 x 22 m	88275561	YS2557	335,97
Chromaluxe Endura Sheet 1,5 x 1m	88275579	YS2723	16,80
Chromaluxe Heat Gloves - 1 pair	88275580	YS2724	21,08
Chromaluxe Heat Resistant Tape - 1 roll	88275581	YS2725	16,67

## STAHL'S Heat Presses

Description	Ref. Papyrus	€
Basic Range • Attractive price • Digital time and temperature readout		



<b>STAHL'S Clam Basic blue 38 x 28 cm</b> 8 Amps/ 1000 Watts • 24 Kg Ship Weight	13656	525,00
<b>STAHL'S Clam Basic blue 38 x 38cm</b> 15 Amps/ 1750 Watts • 30 Kg Ship Weight	110877	625,00
<b>STAHL'S Clam Basic blue 40 x 50cm</b> 15 Amps/ 1750 Watts • 35 Kg Ship Weight	110878	775,00
<b>STAHL'S Clam Basic "Cap" blue 9 x 16cm</b>	121875	525,00



4 Amps/ 500 Watts • 22 Kg Ship Weight

Maxx Range

The Perfect partner for your start-up business • Interchangeable Lower Platens

<b>STAHL'S MAXX Clam 28 x 38cm</b>	110876	812,50
------------------------------------	--------	--------



8 Amps/ 1000 Watts • 91cm L x 64cm W x 21cm H • 32 Kg Ship Weight

## STAHL'S Heat Presses

Description	Ref. Papyrus	€
<b>Maxx Range</b> The Perfect partner for your start-up business • Interchangeable Lower Platens		
STAHL'S MAXX Clam 38 x 38cm	13657	1 025,00



15 Amps/ 1800 Watts • 91cm L x 64cm W x 21cm H • 35 Kg Ship Weight

STAHL'S MAXX Clam 40 x 50cm	13658	1 250,00
-----------------------------	-------	----------



15 Amps/ 1800 Watts • 91cm L x 64cm W x 21cm H • 47 Kg Ship Weight

STAHL'S MAXX Cap 9 x 16cm	13659	812,50
---------------------------	-------	--------



4 Amps/ 500 Watts • 66cm L x 38cm W x 53cm H • 18 Kg Ship Weight

## STAHL'S Heat Presses

Description	Ref. Papyrus	€
-------------	-----------------	---

### Sprint Mag Range

The gold standard for multi-taskers • Magnetic auto-open feature • Twin Timer for preheating or two-step applications • Interchangeable Lower Platens



<b>STAHL'S Sprint Mag XS 15 x 15cm</b> 3 Amps/ 360 Watts • 66cm L x 38cm W x 53cm H • 18 Kg Ship Weight	<b>10938</b>	<b>1 056,25</b>
<b>STAHL'S Sprint Mag Digital 28 x 38cm</b> 8 Amps/ 1000 Watts • 91cm L x 64cm W x 53cm H • 32 Kg Ship Weight	<b>13645</b>	<b>1 181,25</b>
<b>STAHL'S Sprint Mag Digital 40 x 40cm</b> 15 Amps/ 1800 Watts • 91cm L x 64cm W x 53cm H • 40 Kg Ship Weight	<b>13646</b>	<b>1 562,50</b>
<b>STAHL'S Sprint Mag Digital 40 x 50cm</b> 15 Amps/ 1800 Watts • 91cm L x 64cm W x 53cm H • 45 Kg Ship Weight	<b>13647</b>	<b>1 811,67</b>
<b>STAHL'S Sprint Mag Hover 40 x 50cm</b> 15 Amps/ 1800 Watts • 91cm L x 64cm W x 53cm H • 45 Kg Ship Weight	<b>13648</b>	<b>2 125,00</b>



<b>STAHL'S Sprint Mag Cap 9 x 16cm</b> 4 Amps/ 500 Watts • 66cm L x 38cm W x 53cm H • 18 Kg Ship Weight	<b>13649</b>	<b>1 056,25</b>
--	--------------	-----------------

## STAHL'S Heat Presses

Description	Ref. Papyrus	€
<b>Hotronix Fusion Range</b> Threadable Platen • Twin Timer for preheating or two-step applications • Interchangeable Lower Platens • Auto Presets • Touch Screen		



### STAHL'S Hotronix Fusion 40 x 50cm

13651

2 625,00

15 Amps/ 1800 Watts • 99cm L x 64cm W x 61cm H • 68 Kg Ship Weight

### Hotronix Air Fusion Range

Pressure AutoAdjusted to the thickness • Interchangeable Lower Platens • Auto Presets • Touch Screen • Requires air compressor (sold separately)



### STAHL'S Hotronix Air Fusion 40 x 50cm

142082

5 186,67

10 Amps/ 2250 Watts • 102cm L x 81cm W x 145cm H • 69 Kg



### STAHL'S Hotronix Air Fusion TableTop 40 x 50cm

125303

4 786,67

10 Amps/ 2250 Watts • 86cm L x 46cm W x 61cm H • 57 Kg

## STAHL'S Heat Presses

Description	Ref. Papyrus	€
-------------	-----------------	---

**Hotronix Air Fusion Range**  
 Pressure AutoAdjusted to the thickness • Interchangeable Lower Platen • Auto Presets • Touch Screen • Requires air compressor (sold separately)



<b>STAHL'S Hotronix DualAir Fusion 40 x 50cm with Laser Alignment System</b>	<b>162908</b>	<b>8 666,67</b>
10 Amps/ 2250 Watts • 97cm L x 97cm W x 66cm H • 118 Kg		

### Accessories

STAHL'S Foot Caddie Sprint Mag/MAXX	88203938	125187	436,25
STAHL'S Counter Caddie Sprint MAG/MAXX	88203941	184814	225,00
STAHL'S Caddie Shelves Air Fusion	88203941	140027	187,50
STAHL'S Compressor SIL 50-24 AL	88203942	162848	1 000,00
STAHL'S Compressor Panther 100-24 AL	88203943	162849	2 073,33
STAHL'S Laser Stand Alone and L.A. Wizard	88203944	N-Kit- 3-1298	437,50
STAHL'S Pedestal Stand Assembly	88204043	N-1-2291	437,50
STAHL'S Shoe Platen 15 x 38cm	88203945	N-Kit-3-6950	331,67
STAHL'S Sleeve Leg Platen 15 x 51cm	88203946	N-Kit-3-6958	331,67
STAHL'S Shortstop Platen Fusion 15 x 25cm	88203947	N-Kit-3-6926	206,25
STAHL'S Tote Master Platen Fusion 20x25cm	88203948	N-Kit-3-6927	206,25
STAHL'S Nonstick ProtCovBrownTextile40x50cm	88203949	013676	68,75
STAHL'S NonStickProtCovHeatPlate 40x50cm	88203951	125288	75,00
STAHL'S Cover Sheet Reusable 46 x 49cm	88203952	013683	15,32
STAHL'S Cover Sheet Grip 38 x 48cm	88203953	013685	0,60
STAHL'S Heat Printing Pillow 16 x 20cm	88203954	013679	31,25
STAHL'S Heat Printing Pillow 25 x 25cm	88203955	013680	31,25
STAHL'S Weeder	88203956	013695	21,25
STAHL'S Print Perfect Pad 9 x 40cm	88203957	162120	43,75
STAHL'S Print Perfect Pad 13 x 15cm	88203958	162121	31,25
STAHL'S Squeegee	88203959	013696	3,13

## CANON PRINTERS

Description	Ref. Papyrus	€
<b>CANON iPF PRO 8 Colour Printers</b>		
<b>iPF PRO-4000S</b>	<b>1123C003AA</b>	<b>4 927,00</b>
Roll-Unit RU-41 (Optional 2nd Roll Unit)	1152C002AA	740,00
<b>iPF PRO-6000S</b>	<b>1126C003AB</b>	<b>9 500,00</b>
Roll-Unit RU-61 'Mandatory Option !!'	1152C003AA	900,00
<b>CANON iPF PRO 12 Colour Printers</b>		
<b>iPF PRO-1000</b>	<b>0608C025AB</b>	<b>1 050,00</b>
<b>iPF PRO-2000</b>	<b>1124C003AA</b>	<b>3212</b>
Printer Stand SD-21	1151C001AA	273,00
Roll Unit RU-21 (Optional 2nd Roll Unit)	1152C001AA	700,00
<b>iPF PRO-4000</b>	<b>1127C003AA</b>	<b>5 476,30</b>
Roll-Unit RU-41 (Optional 2nd Roll Unit)	1152C002AA	740,00
<b>iPF PRO-6000 - 60" - 11 cls -</b>	<b>1126C003AB</b>	<b>11 250,00</b>
Roll-Unit RU-41 (Optional 2nd Roll Unit)	1152C003AA	900,00
<b>CANON iPF - 5 COLOUR PRINTERS</b>		
<b>iPF510</b>	<b>2158B003AB</b>	<b>1 250,00</b>
Printer Stand ST-11	1255B006AA	231,00
Auto Roll Feed Unit RU-02	1318B003AA	157,50
Roll Holder Set RH2-11	1465B001BA	59,77
<b>iPF610</b>	<b>2159B003AA</b>	<b>2 205,00</b>
Printer Stand ST-24	1255B008AB	260,00
Roll Holder Set RH2-24	1465B002BA	90,56
<b>iPF670</b>	<b>9854B003AB</b>	<b>1 406,00</b>
Printer Stand ST-27	1255B023AA	260,00
Roll Holder Set RH2-26	1465B014AA	90
<b>iPF680</b>	<b>8964B003AA</b>	<b>2 205,00</b>
Printer Stand ST-27	1255B023AA	260,00
Roll Holder Set RH2-26	1465B014AA	90
<b>iPF685</b>	<b>8970B003AA</b>	<b>2 495,00</b>
Printer Stand ST-27	1255B023AA	260,00
Roll Holder Set RH2-26	1465B014AA	90,00
<b>iPF770 (Printer Stand INCLUDED)</b>	<b>9856B003AA</b>	<b>2 150,00</b>
Roll Holder Set RH2-33	1465B013AA	113,40
<b>iPF780 (Printer Stand INCLUDED)</b>	<b>8967B003AA</b>	<b>2 750,00</b>
Roll Holder Set RH2-33	1465B013AA	113,40
<b>iPF785 (Printer Stand INCLUDED)</b>	<b>8966B003AA</b>	<b>3 150,00</b>
Roll Holder Set RH2-33	1465B013AA	113,40
<b>CANON TX SERIES - 5 COLOUR PRINTERS</b>		
<b>TX-2000 - 609,6mm</b>	<b>2442C003AA</b>	<b>2 950,00</b>
Printer stand SD-21	1151C001AA	273,00
2nd Roll Unit - RU-22	2455C001AA	754,00
Sheet Stacker SS-21	2456C001AA	375,00
<b>TX-3000 - 914,4mm</b>	<b>2443C003AA</b>	<b>3 500,00</b>
2nd Roll Unit - RU-32	2455C002AA	925,00
Sheet Stacker SS-31	2456C002AA	431,00
<b>TX-4000 - 1117,6mm</b>	<b>2444C003AA</b>	<b>4 000,00</b>
2nd Roll Unit - RU-22	2455C003AA	1 100,00
Sheet Stacker SS-21	2456C003AA	500,00

## CANON PRINTERS

Description	Ref. Papyrus	€
<b>CANON imagePROGRAF TM-Series - 5 COLOUR PRINTERS</b>		
<b>TM-300 - 914,4mm - Stand Included</b>	<b>3058C003AA</b>	<b>2 150,00</b>
<b>CANON MFP SOLUTIONS</b>		
<b>iPF770 MFP</b>		<b>6 075,00</b>
iPF770 (Printer Stand INCLUDED)	9856B003AA	2 150,00
MFP Scanner M40	2289V962	3 925,00
SmartWorks EZ standard software		
22" Flatscreen display + VGA Cable		
Repro Stand for scanner and display		
Computer not included !		
<b>iPF780 MFP</b>		<b>6 675,00</b>
iPF780 (Printer Stand INCLUDED)	8967B003AA	2 750,00
MFP Scanner M40	2289V962	3 925,00
SmartWorks EZ standard software		
22" Flatscreen display + VGA Cable		
Repro Stand for scanner and display		
Computer not included !		
<b>iPF785 MFP</b>		<b>7 075,00</b>
iPF785 (Printer Stand INCLUDED)	8966B003AA	3 150,00
MFP Scanner M40 ( )	2289V962	3 925,00
SmartWorks EZ standard software		
22" Flatscreen display + VGA Cable		
Repro Stand for scanner and display		
Computer not included !		
<b>MFP Solution T36 Scanner with PC - TX-3000</b>		<b>6 815,00</b>
TX-3000 (36") (Stand Included)	2443C003AA	3 500,00
MFP Scanner T36	3308V474	3 315,00
MFP SmartWorks software		
Stand assembly for T36 scanner and TFT display		
15.6" TFT Display - AIO PC included - Windows 10 Enterprise		
<b>MFP Solution T36 Scanner with PC - TX-4000</b>		<b>7 315,00</b>
TX-4000 (44") (Stand Included)	2444C003AA	4 000,00
MFP Scanner T36	3308V474	3 315,00
MFP SmartWorks software		
Stand assembly for T36 scanner and TFT display		
15.6" TFT Display - AIO PC included - Windows 10 Enterprise		
<b>MFP Solution with L - Scanner</b>		<b>3 510,00</b>
IPF 670	8954B003AA	1 406,00
Printer Stand ST-27	1255B023AA	260,00
L24e scanner	3143V676	1 844,00
MFP SmartWorks software		



# Papyrus Viscom

Prijzlijst / Liste de prix  
Viscom Supplies

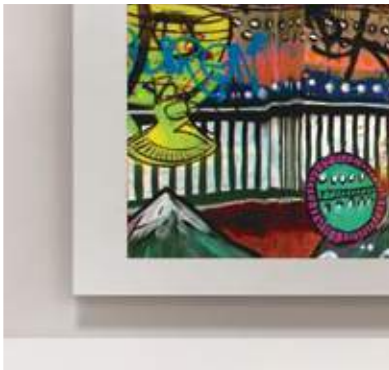

**PAPYRUS**   
Your partner in Visual Communication



# Viscom Supplies

## Current Canon Printers Supplies

Supplies for iPF PRO-1000	
Inks - 80 ml.	301
Maintenance cartridges	301
Supplies for iPF PRO-2000 - iPF PRO-4000 - iPF PRO-6000 - iPF PRO-4000S - iPF PRO-6000S	
Inks - 160 ml.	301
Inks - 330 ml.	301
Inks - 700 ml.	302
Maintenance cartridges and Print Heads	302
Supplies for iPF510 - iPF610	
Inks - 130 ml.	302
Maintenance cartridges and Print Heads	302
Supplies for iPF6400SE	
Inks - 130 ml.	302
Inks - 300 ml.	302
Maintenance cartridges and Print Heads	302
Supplies for iPF680 - iPF685 - iPF770 - iPF780 - iPF785	
Inks - 130 ml.	303
Inks - 300 ml.	303
Maintenance cartridges and Print Heads	303
Supplies for iPF830 - iPF840 - iPF850	
Inks - 300 ml.	303
Supplies for imagePROGRAF TX-2000, TX-3000, TX-4000	
Inks - 330 ml.	303
Inks - 700 ml.	303
Maintenance cartridges and Print Heads	303
Inks - 700 ml.	303
Maintenance cartridges and Print Heads	303
Supplies for iPF8400SE - iPF9400	
Inks - 300 ml.	304
Inks - 700 ml.	304
Maintenance cartridges and Print Heads	304

## Current Mutoh Printers Supplies

Supplies for VALUEJET SIGN and DISPLAY PRINTERS	
Eco Ultra 220 ml. For ValueJet 628, 1324, 1604X, 1624X, 1638X, 2638X	305
Eco Ultra 440 ml. For ValueJet 1624X, 1638X, 2638X	305
Eco Ultra 1L. For Vj628, 1324, 1604X, 1624X, 1638X, 2638X	305
Universal Mild Solvent 440 ml. For ValueJet 1624X, 1638X, 2638X	305
Universal Mild Solvent 1L. Bags For Vj1324, 1604X, 1624X, 1638X, 2638X	305
Cleaning Liquids	305

## Current Mutoh Printers Supplies

Supplies for XpertJet SIGN and DISPLAY PRINTERS	
MS41 Eco Solvent 1000 ml. for XpertJet 1641SR / 1682SR	306
MS41 Eco Solvent 300 ml. for XpertJet 1641SR / 1682SR	306
Supplies for VALUEJET SPECIALTY / INDUSTRIAL PRINTERS	
LED UV 220 ml. For ValueJet 426UF, 626UF, 1626UH, 1638UH	307
LED FLEX UV 220 ml. For ValueJet 426UF, 626UF, 1626UH, 1638UH	307
Rigid LED UV Ink – 800 ml / 500 ml pack For ValueJet 426UF, 626UF, 1626UH, 1638UH	307
Flexible LED UV Ink – 800 ml / 500 ml pack For ValueJet 426UF, 626UF, 1626UH, 1638UH	307
Cleaning Liquids	307
Supplies for VALUEJET MP11 HYBRID PRINTERS	
MP31 500 ml. For ValueJet Hybrid VJ-1617H	307
Cleaning Liquids	307
Supplies for VALUEJET INDOOR and DIGITAL TRANSFER PRINTERS	
DS2 Transfert Printing 1L. For ValueJet 1624WX, 1638WX, 1924W, 1938WX, 2638 Dye Sub, DrafStation RJ-900XG	308
RJ9 CAD/Imaging 110 ml. For DrafStation RJ-900XG	308
RJ9 CAD/Imaging 220 ml. For DrafStation RJ-900XG	308
Cleaning Liquids	308
Supplies for VALUEJET DIRECT TEXTILEPRINTERS	
DS2 Transfert Printing 1L. For ValueJet 1624WX, 1638WX, 1924W, 1938WX, 2638 Dye Sub, DrafStation RJ-900XG	308
Cleaning Liquids	308
ACCESSORIES	
Eco Ultra Open Cassettes	308

## Current Sawgrass Printers Supplies

### Supplies for Sawgrass Virtuoso VJ-628 Printer

Sawgrass Sublijet-HD 220 ml. For Virtuoso VJ-628 and Mutoh 1638W  
Sawgrass Sublijet-HD 1Kg. For Virtuoso VJ-628 and Mutoh 1638W

309  
309

## Current Epson Printers Supplies

### Supplies for Epson SureColor SC-S80600

Epson UltraChrome GS3 Ink - 700 ml.

310

### Supplies for Epson SureColor SC-S80600L

Epson UltraChrome GS3 Ink - 1,5l

310

## Current Canon Printers Supplies

Description	Ref. Cannon	Info	Ref. Papyrus	€
<b>Supplies for iPF PRO-1000</b>				
<b>Inks - 80 ml.</b>				
PFI-1000 MBK	0545C001AA	🕒		44,60
PFI-1000 B	0555C001AA	🕒		44,60
PFI-1000 C	0547C001AA	🕒		44,60
PFI-1000 CO (Croma Optimizer)	0556C001AA	🕒		44,60
PFI-1000 GY	0552C001AA			44,60
PFI-1000 M	0548C001AA	🕒		44,60
PFI-1000 PBK	0546C001AA	🕒		44,60
PFI-1000 PC	0550C001AA	🕒		44,60
PFI-1000 PGY	0553C001AA	🕒		44,60
PFI-1000 PM	0551C001AA	🕒		44,60
PFI-1000 R	0554C001AA	🕒		44,60
PFI-1000 Y	0549C001AA	🕒		44,60
<b>Maintenance cartridges</b>				
Maintenance Cartridge MC-20	0628C002AA	🕒		17,50
<b>Supplies for iPF PRO-2000 - iPF PRO-4000 - iPF PRO-6000 - iPF PRO-4000S - iPF PRO-6000S</b>				
<b>Inks - 160 ml.</b>				
PFI-1100 Blue	0859C001AA	Only Valid For iPF PRO-2000/4000/6000 🕒	88195279	82,58
PFI-1100 Chroma Optimizer	0860C001AA	Only Valid For iPF PRO-2000/4000/6000 🕒	88195280	82,58
PFI-1100 Photo Grey	0857C001AA	Only Valid For iPF PRO-2000/4000/6000 🕒	88192274	82,58
PFI-1100 Red	0858C001AA	Only Valid For iPF PRO-2000/4000/6000 🕒	88195241	82,58
PFI-1100 Cyan	0851C001AA	🕒	88192265	82,58
PFI-1100 Grey	0856C001AA	🕒	88192271	82,58
PFI-1100 Magenta	0852C001AA	🕒	88192266	82,58
PFI-1100 Matte Black	0849C001AA	🕒	88192257	82,58
PFI-1100 Photo Black	0850C001AA	🕒	88192264	82,58
PFI-1100 Photo Cyan	0854C001AA	🕒	88192269	82,58
PFI-1100 Photo Magenta	0855C001AA	🕒	88192270	82,58
PFI-1100 Yellow	0853C001AA	🕒	88192268	82,58
<b>Inks - 330 ml.</b>				
PFI-1300 Blue	0820C001AA	Only Valid For iPF PRO-2000/4000/6000 🕒	88195302	156,56
PFI-1300 Chroma Optimizer	0821C001AA	Only Valid For iPF PRO-2000/4000/6000 🕒	88195303	156,56
PFI-1300 Photo Grey	0818C001AA	Only Valid For iPF PRO-2000/4000/6000 🕒	88195300	156,56
PFI-1300 Red	0819C001AA	Only Valid For iPF PRO-2000/4000/6000 🕒	88195301	156,56
PFI-1300 Cyan	0812C001AA	🕒	88195285	156,56
PFI-1300 Grey	0817C001AA	🕒	88195291	156,56
PFI-1300 Magenta	0813C001AA	🕒	88195286	156,56
PFI-1300 Matte Black	0810C001AA	🕒	88195281	156,56
PFI-1300 Photo Black	0811C001AA	🕒	88195284	156,56
PFI-1300 Photo Cyan	0815C001AA	🕒	88195289	156,56
PFI-1300 Photo Magenta	0816C001AA	🕒	88195290	156,56
PFI-1300 Yellow	0814C001AA	🕒	88195287	156,56

## Current Canon Printer Supplies

Description	Ref. Cannon	Info	Ref. Papyrus	€
-------------	----------------	------	-----------------	---

### Supplies for iPF PRO-2000 - iPF PRO-4000 - iPF PRO-6000 - iPF PRO-4000S - iPF PRO-6000S

#### Inks - 700 ml.

PFI-1700 Blue	0784C001AA	Only Valid For iPF PRO-2000/4000/6000	88195333	258,60
PFI-1700 Chroma Optimizer	0785C001AA	Only Valid For iPF PRO-2000/4000/6000	88195334	258,60
PFI-1700 Photo Grey	0782C001AA	Only Valid For iPF PRO-2000/4000/6000	88195330	258,60
PFI-1700 Red	0783C001AA	Only Valid For iPF PRO-2000/4000/6000	88195332	258,60
PFI-1700 Cyan	0776C001AA		88195323	258,60
PFI-1700 Grey	0781C001AA		88195329	258,60
PFI-1700 Magenta	0777C001AA		88195324	258,60
PFI-1700 Matte Black	0774C001AA		88195305	258,60
PFI-1700 Photo Black	0775C001AA		88195306	258,60
PFI-1700 Photo Cyan	0779C001AA		88195327	258,60
PFI-1700 Photo Magenta	0780C001AA		88195328	258,60
PFI-1700 Yellow	0778C001AA		88195326	258,60

#### Maintenance cartridges and Print Heads



Maintenance Cartridge MC-30	1156C002AA		88192249	56,00
Print Head PF-10	0861C001AA		88192256	520,00

### Supplies for iPF510 - iPF610

#### Inks - 130 ml.





Black Ink Tank PFI-102BK	0895B001AA		88104327	65,00
Cyan Ink Tank PFI-102C	0896B001AA		88104328	65,00
Magenta Ink Tank PFI102M	0897B001AA		88104329	65,00
Matte Black Ink Tank PFI-102MBK	0894B001AA		88104326	65,00
Yellow Ink Tank PFI-102Y	0898B001AA		88104330	65,00

#### Maintenance cartridges and Print Heads

Maintenance Cartridge MC-05 (UNI)	1320B003AA	For iPF510, 	88104379	33,81
Maintenance Cartridge MC-16	1320B010AA	For iPF610, 	88104382	47,00
Print Head PF-03	QY6-1501-000		88104392	472,00

### Supplies for iPF6400SE

#### Inks - 130 ml.

Black Ink Tank PFI-106BK	6621B001AA		88174761	73,00
Cyan Ink Tank PFI-106C	6622B001AA		88174752	73,00
Magenta Ink Tank PFI-106M	6623B001AA		88174753	73,00
Matt Black Ink Tank PFI-106MBK	6620B001AA		88174750	73,00
Red Ink Tank PFI-106R	6627B001AA		88174759	73,00
Yellow Ink Tank PFI-106Y	6624B001AA		88174754	73,00

### Supplies for iPF6400SE

#### Inks - 300 ml.

Black Ink Tank PFI-206BK	5303B001AA			150,00
Cyan Ink Tank PFI-206C	5304B001AA			150,00
Magenta Ink Tank PFI-206M	5305B001AA			150,00
Matt Black Ink Tank PFI-206MBK	5302B001AA			150,00
Red Ink Tank PFI-206R	5309B001AA			150,00
Yellow Ink Tank PFI-206Y	5306B001AA			150,00

#### Maintenance cartridges and Print Heads

Maintenance Cartridge MC-16	1320B010AA		88104382	47,00
Print Head PF-05	QY6-1701-040		88104393	472,00

## Current Canon Printer Supplies

Description	Ref. Cannon	Info	Ref. Papyrus	€
-------------	-------------	------	--------------	---

### Supplies for iPF680 - iPF685 - iPF770 - iPF780 - iPF785

#### Inks - 130 ml.

Black Ink Tank PFI-107BK	6705B001AA		74002608	65,00
Cyan Ink Tank PFI-107C	6706B001AA		74002609	65,00
Magenta Ink Tank PFI-107M	6707B001AA		74002610	65,00
Matte Black Ink Tank PFI-107MBK	6704B001AA		74002607	65,00
Yellow Ink Tank PFI-107Y	6708B001AA		74002611	65,00

#### Inks - 300 ml.

Black Ink Tank PFI-207BK	8789B001AA	Not suitable for iPF770, ⌚	74002613	123,00
Cyan Ink Tank PFI-207C	8790B001AA	Not suitable for iPF770, ⌚	74002614	123,00
Magenta Ink Tank PFI-207M	8791B001AA	Not suitable for iPF770, ⌚	74002615	123,00
Matte Black Ink Tank PFI-207MBK	8788B001AA	Not suitable for iPF770, ⌚	74002612	123,00
Yellow Ink Tank PFI-207Y	8792B001AA	Not suitable for iPF770, ⌚	74002616	123,00

#### Maintenance cartridges and Print Heads

Maintenance Cartridge MC-10	1320B014AA		88104384	47,00
Print Head PF-04	QY6-1601-000		88110415	472,00

### Supplies for iPF830 - iPF840 - iPF850

#### Inks - 300 ml.

Black ink tank PFI-307BK	9811B001AA	⌚		150,00
Cyan ink tank PFI-307C	9812B001AA	⌚		150,00
Magenta ink tank PFI-307M	9813B001AA	⌚		150,00
Matte Black ink tank PFI-307MBK	9810B001AA	⌚		150,00
Yellow ink tank PFI-307Y	9814B001AA	⌚		150,00

### Supplies for imagePROGRAF TX-2000, TX-3000, TX-4000

#### Inks - 330 ml.

Matte black ink tank PFI-310 MBK	2358C001AA	⌚	88268713	150,00
Black ink tank PFI-310 BK	2359C001AA	⌚	88268717	150,00
Cyan ink tank PFI-310 C	2360C001AA	⌚	88268719	150,00
Magenta ink tank PFI-310 M	2361C001AA	⌚	88268723	150,00
Yellow ink tank PFI-310 Y	2362C001AA	⌚	88268724	150,00

#### Inks - 700 ml.

Matte black ink tank PFI-710 MBK	2353C001AA		88268729	265,00
Black ink tank PFI-710 BK	2354C001AA		88268730	265,00
Cyan ink tank PFI-710 C	2355C001AA		88268732	265,00
Magenta ink tank PFI-710 M	2356C001AA		88268733	265,00
Yellow ink tank PFI-710 Y	2357C001AA		88268734	265,00

#### Maintenance cartridges and Print Heads

Maintenance Cartridge MC-30	1156C002AA		88192249	56,00
Print Head PF-06	2352C001AA	⌚	88294169	472,00

### Supplies for iPF830 - iPF840 - iPF850

#### Inks - 700 ml.

Black ink tank PFI-707BK	9821B001AA		88171922	265,00
Cyan ink tank PFI-707C	9822B001AA		88171923	265,00
Magenta ink tank PFI-707M	9823B001AA		88171924	265,00
Matte black ink tank PFI-707MBK	9820B001AA		88171920	265,00
Yellow ink tank PFI-707Y	9824B001AA		88171925	265,00

#### Maintenance cartridges and Print Heads

Maintenance cartridge MC-10	1320B014BA		88104384	47,00
Print Head PF-04	QY6-1601-000		88110415	472,00

## Current Canon Printer Supplies

Description	Ref. Cannon	Info	Ref. Papyrus	€
<b>Supplies for iPF8400SE - iPF9400</b>				
<b>Inks - 300 ml.</b>				
Black Ink Tank PFI-306BK	6657B001AA	⌚		170,00
Cyan Ink Tank PFI-306C	6658B001AA	⌚		170,00
Magenta Ink Tank PFI-306M	6659B001AA	⌚		170,00
Matte Black Ink Tank PFI-306MBK	6656B001AA	⌚		170,00
Red Ink Tank PFI-306R	6663B001AA	⌚		170,00
Yellow Ink Tank PFI-306Y	6660B001AA	⌚		170,00
Blue Ink Tank PFI-306B	6665B001AA	Only for iPF 9400, ⌚		170,00
Green Ink Tank PFI-306G	6664B001AA	Only for iPF 9400, ⌚		170,00
Grey Ink Tank PFI-306GY	6666B001AA	Only for iPF 9400, ⌚		170,00
Photo Cyan Ink Tank PFI-306PC	6661B001AA	Only for iPF 9400, ⌚		170,00
Photo Grey Ink Tank PFI-306PGY	6667B001AA	Only for iPF 9400, ⌚		170,00
Photo Magenta Ink Tank PFI-306PM	6662B001AA	Only for iPF 9400, ⌚		170,00
<b>Inks - 700 ml.</b>				
Black Ink Tank PFI-706BK	6681B001AA		88119091	295,00
Cyan Ink Tank PFI-706C	6682B001AA		88119092	295,00
Magenta Ink Tank PFI-706M	6683B001AA		88119094	295,00
Matte Black Ink Tank PFI-706MBK	6680B001AA		88119090	295,00
Red Ink Tank PFI-706R	6687B001AA	⌚	88119102	295,00
Yellow Ink Tank PFI-706Y	6684B001AA		88119097	295,00
Blue Ink Tank PFI-706B	6689B001AA	Only for iPF 9400 - ⌚	88119104	295,00
Green Ink Tank PFI-706G	6688B001AA	Only for iPF 9400	88119103	295,00
Grey Ink Tank PFI-706GY	6690B001AA	Only for iPF 9400	88119105	295,00
Photo Cyan Ink Tank PFI-706PC	6685B001AA	Only for iPF 9400	88119099	295,00
Photo Grey Ink Tank PFI-706PGY	6691B001AA	Only for iPF 9400	88119106	295,00
Photo Magenta Ink Tank PFI-706PM	6686B001AA	Only for iPF 9400	88119100	295,00
<b>Maintenance cartridges and Print Heads</b>				
Maintenance Cartridge MC-08 (UNI)	1320B006AA		88104380	56,00
Print Head PF-05	QY6-1701-040		88104393	472,00



## Current Mutoh Printers Supplies

Description	Ref. Supplier	Info	Ref. Papyrus	€
<b>Supplies for VALUEJET SIGN and DISPLAY PRINTERS</b>				
<b>Eco Ultra 220 ml. For ValueJet 628, 1324, 1604X, 1624X, 1638X, 2638X</b>				
220 ml Eco Ultra ink cassette - Black	VJ-MSI3A-BK220		88120368	69,00
220 ml Eco Ultra ink cassette - Cyan	VJ-MSI3A-CY220		88120370	69,00
220 ml Eco Ultra ink cassette - Magenta	VJ-MSI3A-MA220		88120371	69,00
220 ml Eco Ultra ink cassette - Yellow	VJ-MSI3A-YE220		88120375	69,00
<b>Eco Ultra 440 ml. For ValueJet 1624X, 1638X, 2638X</b>				
440 ml Eco Ultra ink cassette - Black	VJ-MSI3A-BK440		88104408	114,00
440 ml Eco Ultra ink cassette - Cyan	VJ-MSI3A-CY440		88104409	114,00
440 ml Eco Ultra ink cassette - Magenta	VJ-MSI3A-MA440		88104407	114,00
440 ml Eco Ultra ink cassette - Yellow	VJ-MSI3A-YE440		88104406	114,00
<b>Eco Ultra 1L. For VJ628, 1324, 1604X, 1624X, 1638X, 2638X</b>				
1 Litre Eco Ultra ink pack - Black	VJ-MSI3A-BK1000 *		88158214	179,00
1 Litre Eco Ultra ink pack - Cyan	VJ-MSI3A-CY1000 *		88158211	179,00
1 Litre Eco Ultra ink pack - Magenta	VJ-MSI3A-MA1000 *		88158212	179,00
1 Litre Eco Ultra ink pack - Yellow	VJ-MSI3A-YE1000 *		88158213	179,00
<b>Universal Mild Solvent 440 ml. For ValueJet 1624X, 1638X, 2638X</b>				
440 ml UMS ink cassette (with Eco smart chip) - Black	VJ-LSINK1-BK44		88131442	69,00
440 ml UMS ink cassette (with Eco smart chip) - Cyan	VJ-LSINK1-CY44		88131434	69,00
440 ml UMS ink cassette (with Eco smart chip) - Magenta	VJ-LSINK1-MA44		88131437	69,00
440 ml UMS ink cassette (with Eco smart chip) - Yellow	VJ-LSINK1-YE44		88131439	69,00
<b>Universal Mild Solvent 1L. Bags For Vj1324, 1604X, 1624X, 1638X, 2638X</b>				
1000 ml UMS ink Bag - Black	VJ-LSINK1-BK1LB **		88182681	99,00
1000 ml UMS ink Bag - Cyan	VJ-LSINK1-CY1LB **		88182682	99,00
1000 ml UMS ink Bag - Magenta	VJ-LSINK1-MA1LB **		88182683	99,00
1000 ml UMS ink Bag - Yellow	VJ-LSINK1-YE1LB **		88182684	99,00
<b>Cleaning Liquids</b>				
220 ml eco-solvent cleaning cassette for initial start-up or washing	VJ-MSI3-CL220		74002493	63,00
500 ml bottle cleaning liquid for periodical maintenance	VJ-ULVA1-HL500		88239357	63,00
440 ml UMS cleaning cassette for washing and long store	VJ-LSINK1-CL44		74003264	59,00
1 liter bottle UMS cleaning liquid for periodical maintenance	RJ80UMS-100-CLN		74002566	38,00

\* : Requires Eco Ultra Open Cassettes, see section "Accessories".

\*\* : Requires Ums Open Cassettes, see section "Accessories".

## Current Mutoh Printers Supplies

Description	Ref. Supplier	Info	Ref. Papyrus	€
<b>Supplies for XpertJet SIGN and DISPLAY PRINTERS</b>				
<b>MS41 Eco Solvent 1000 ml. for XpertJet 1641SR / 1682SR</b>				
1000 ml eco-solvent MS41 ink pack – Cyan	MS41-CY1000E		88298529	149,00
1000 ml eco-solvent MS41 ink pack – Magenta	MS41-MA1000E		88298531	149,00
1000 ml eco-solvent MS41 ink pack – Yellow	MS41-YE1000E		88298533	149,00
1000 ml eco-solvent MS41 ink pack – Black	MS41-BK1000E		88298534	149,00
1000 ml eco-solvent MS41 ink pack – Light Cyan (for XpertJet 1682SR only)	MS41-LC1000E		88298535	149,00
1000 ml eco-solvent MS41 ink pack – Light Magenta (for XpertJet 1682SR only)	MS41-LM1000E		88298536	149,00
1000 ml eco-solvent MS41 ink pack – Light Black (for XpertJet 1682SR only)	MS41-LK1000E		88298537	149,00
<b>MS41 Eco Solvent 300 ml. for XpertJet 1641SR / 1682SR</b>				
300 ml eco-solvent MS41 ink pack – Cyan	MS41-CY300E		88311519	69,00
300 ml eco-solvent MS41 ink pack – Magenta	MS41-MA300E		88311521	69,00
300 ml eco-solvent MS41 ink pack – Yellow	MS41-YE300E		88311522	69,00
300 ml eco-solvent MS41 ink pack – Black	MS41-BK300E		88311523	69,00
300 ml eco-solvent MS41 ink pack – Light Cyan (for XpertJet 1682SR only)	MS41-LC300E		88311524	69,00
300 ml eco-solvent MS41 ink pack – Light Magenta (for XpertJet 1682SR only)	MS41-LM300E		88311525	69,00
300 ml eco-solvent MS41 ink pack – Light Black (for XpertJet 1682SR only)	MS41-LK300E		88311526	69,00

## Current Mutoh Printers Supplies

Description	Ref. Supplier	Info	Ref. Papyrus	€
<b>Supplies for VALUEJET SPECIALTY / INDUSTRIAL PRINTERS</b>				
<b>LED UV 220 ml. For ValueJet 426UF, 626UF, 1626UH, 1638UH</b>				
220 ml LED UV ink - cassette - black	VJ-LUH1-BK220E		88151936	64,00
220 ml LED UV ink - cassette - cyan	VJ-LUH1-CY220E		88151933	64,00
220 ml LED UV ink - cassette - magenta	VJ-LUH1-MA220E		88151934	64,00
220 ml LED UV ink - cassette - yellow	VJ-LUH1-YE220E		88151935	64,00
220 ml LED UV ink - cassette - white	VJ-LUH1-WH220E		88151937	54,00
220 ml LED UV ink - cassette - varnish	VJ-LUH1-VA220E		88151938	54,00
<b>LED FLEX UV 220 ml. For ValueJet 426UF, 626UF, 1626UH, 1638UH</b>				
220 ml FLEX LED UV ink - cassette - Black	US11-BK220E		88245890	64,00
220 ml FLEX LED UV ink - cassette - Cyan	US11-CY220E		88245885	64,00
220 ml FLEX LED UV ink - cassette - Magenta	US11-MA220E		88245886	64,00
220 ml FLEX LED UV ink - cassette - Yellow	US11-YE220E		88245889	64,00
220 ml FLEX LED UV ink - cassette - White	US11-WH220E		88245892	54,00
220 ml FLEX LED UV ink - cassette - Varnish	US11-VA220E		88245895	54,00
<b>Rigid LED UV Ink – 800 ml / 500 ml pack For ValueJet 426UF, 626UF, 1626UH, 1638UH</b>				
800 ml LED UV ink - pack - black	VJ-LUH1-BK800E		88208234	125,00
800 ml LED UV ink - pack - cyan	VJ-LUH1-CY800E		88208235	125,00
800 ml LED UV ink - pack - magenta	VJ-LUH1-MA800E		88208237	125,00
800 ml LED UV ink - pack - yellow	VJ-LUH1-YE800E		88208241	125,00
500 ml LED UV ink - pack - white	VJ-LUH1-WH500E		88208245	79,00
800 ml LED UV ink - pack - varnish	VJ-LUH1-VA800E		88208249	125,00
<b>Flexible LED UV Ink – 800 ml / 500 ml pack For ValueJet 426UF, 626UF, 1626UH, 1638UH</b>				
800 ml LED UV ink - pack - black	US11-BK800E		88262448	107,00
800 ml LED UV ink - pack - cyan	US11-CY800E		88262434	107,00
800 ml LED UV ink - pack - magenta	US11-MA800E		88262440	107,00
800 ml LED UV ink - pack - yellow	US11-YE800E		88262447	107,00
500 ml LED UV ink - pack - white	US11-WH500E		88262458	75,00
800 ml LED UV ink - pack - varnish	US11-VA800E		88262459	107,00
<b>Cleaning Liquids</b>				
220 ml cleaning cassette for initial start-up or washing	VJ-LUH1-CL220E		88151940	63
500 ml bottle LED UV maintenance liquid	VJ-ULVA1-ML500			
<b>Supplies for VALUEJET MP11 HYBRID PRINTERS</b>				
<b>MP31 500 ml. For ValueJet Hybrid VJ-1617H</b>				
Mutoh MP31-CY500E	Mutoh MP31-CY500E	🕒	88249031	131,00
Mutoh MP31-MA500E	Mutoh MP31-MA500E	🕒	88249037	131,00
Mutoh MP31-YE500E	Mutoh MP31-YE500E	🕒	88249038	131,00
Mutoh MP31-BK500E	Mutoh MP31-BK500E	🕒	88249040	131,00
Mutoh MP31-WH500E	Mutoh MP31-WH500E	🕒	88249041	249,00
<b>Cleaning Liquids</b>				
Mutoh MP31-CL500E Cleaning	Mutoh MP31-CL500E	🕒	88249042	68,00

## Current Mutoh Printers Supplies

Description	Ref. Supplier	Info	Ref. Papyrus	€
<b>Supplies for VALUEJET INDOOR and DIGITAL TRANSFER PRINTERS</b>				
<b>DS2 Transfert Printing 1L. For ValueJet 1624WX, 1638WX, 1924W, 1938WX, 2638 Dye Sub, DrafStation RJ-900XG</b>				
1 liter bottle DS2-series universal transfer and direct sublimation ink - Black	VJDS2-100-BK	🕒	88166170	79,00
1 liter bottle DS2-series universal transfer and direct sublimation ink - Cyan	VJDS2-100-CY	🕒	88166171	79,00
1 liter bottle DS2-series universal transfer and direct sublimation ink - Magenta	VJDS2-100-MA	🕒	88166172	79,00
1 liter bottle DS2-series universal transfer and direct sublimation ink - Yellow	VJDS2-100-YE	🕒	88166173	79,00
1 liter bottle high speed water based disperse dye ink - Black	RJ80DS1-100-BK		88152300	85,00
1 liter bottle high speed water based disperse dye ink - Cyan	RJ80DS1-100-CY		88152296	85,00
1 liter bottle high speed water based disperse dye ink - Magenta	RJ80DS1-100-MA		88152298	85,00
1 liter bottle high speed water based disperse dye ink - Yellow	RJ80DS1-100-YE		88152299	85,00
<b>RJ9 CAD/Imaging 110 ml. For DrafStation RJ-900XG</b>				
110 ml pigmented DrafStation ink cassette – Black – CAD	RJ9-11-BK	🕒	88170250	74,00
110 ml dye DrafStation ink cassette – Cyan – CAD	RJ9-11-CY	🕒	88170251	59,00
110 ml dye DrafStation ink cassette – Magenta – CAD	RJ9-11-MA	🕒	88170252	59,00
110 ml dye DrafStation ink cassette – Yellow – CAD	RJ9-11-YE	🕒	88170253	59,00
220 ml cassette filled with cleaning liquid for RJ9 and RJ9D ink	RJ9-22-CLN	🕒	88170254	56,00
<b>RJ9 CAD/Imaging 220 ml. For DrafStation RJ-900XG</b>				
220 ml dye ink cassette – Black – Imaging	RJ9D-22-BK			84,00
220 ml dye ink cassette – Cyan – Imaging	RJ9D-22-CY			84,00
220 ml dye ink cassette – Magenta – Imaging	RJ9D-22-MA			84,00
220 ml dye ink cassette – Yellow – Imaging	RJ9D-22-YE			84,00
<b>Cleaning Liquids</b>				
Water-based textile cleaning liquid for printer maintenance – 0.5 l	MY-80844	🕒	74002198	24,00
Water-based textile cleaning liquid for printer maintenance – 1 l	MY-80845	🕒	74002199	35,00
Water-based textile cleaning liquid for printer maintenance - 2l.	MY-80846	🕒		60,00
220 ml cassette filled with cleaning liquid for RJ9 and RJ9D ink	RJ9-22-CLN		88170254	56,00
<b>Supplies for VALUEJET DIRECT TEXTILEPRINTERS</b>				
<b>DS2 Transfert Printing 1L. For ValueJet 1624WX, 1638WX, 1924W, 1938WX, 2638 Dye Sub, DrafStation RJ-900XG</b>				
1 liter bottle DS2-series universal transfer and direct sublimation ink - Black	VJDS2-100-BK		88166170	79,00
1 liter bottle DS2-series universal transfer and direct sublimation ink - Cyan	VJDS2-100-CY		88166171	79,00
1 liter bottle DS2-series universal transfer and direct sublimation ink - Magenta	VJDS2-100-MA		88166172	79,00
1 liter bottle DS2-series universal transfer and direct sublimation ink - Yellow	VJDS2-100-YE		88166173	79,00
<b>Cleaning Liquids</b>				
Water-based textile cleaning liquid for printer maintenance – 0.5 l	MY-80844		74002198	24,00
Water-based textile cleaning liquid for printer maintenance – 1 l	MY-80845		74002199	35,00
Water-based textile cleaning liquid for printer maintenance	MY-80846		88163825	60,00
<b>ACCESSORIES</b>				
<b>Eco Ultra Open Cassettes</b>				
Ink adapter set (set contains 4 adapters) for Eco Ultra ink litre packs 1 set needed for ValueJet 1324(X), ValueJet 1604X or ValueJet 1624(X) 2 sets needed for ValueJet 628, ValueJet 1638(X) or ValueJet 2638(X)	VJ-HCIPADPT		74002654	395/pc
<b>Ums Open Cassettes</b>				
Ink adapter set (set contains 4 adapters) for UMS ink litre packs 1 set needed for ValueJet 1324(X), ValueJet 1604X or ValueJet 1624(X) 2 sets needed for ValueJet 1638(X), ValueJet 2638(X), ValueJet 1638X (3M) or ValueJet 2638X(3M)	VJ-HCIPADPT-UMS		88182670	695/pc

## Current Sawgrass Printers Supplies

Description	Ref. Supplier	Info	Ref. Papyrus	€
<b>Supplies for Sawgrass Virtuoso VJ-628 Printer</b>				
<b>Sawgrass Sublijet-HD 220 ml. For Virtuoso VJ-628 and Mutoh 1638W</b>				
220 ml Sawgrass Sublijet-HD 220 Cyan			88270826	71,00
220 ml Sawgrass Sublijet-HD 220 Magenta			88270834	71,00
220 ml Sawgrass Sublijet-HD 220 Yellow			88270836	71,00
220 ml Sawgrass Sublijet-HD 220 Black XF			88270837	71,00
220 ml Sawgrass Sublijet-HD 220 Light Cyan			88270838	71,00
220 ml Sawgrass Sublijet-HD 220 Light Magenta			88270840	71,00
220 ml Sawgrass Sublijet-HD 220 Light Black XF			88270843	71,00
220 ml Sawgrass Sublijet-HD 220 Light Light Black XF			88270844	71,00
<b>Sawgrass Sublijet-HD 1Kg. For Virtuoso VJ-628 and Mutoh 1638W</b>				
Sawgrass Sublijet-HD 1KG Cyan	507182		88277691	93,18
Sawgrass Sublijet-HD 1KG Magenta	507183		88277692	93,18
Sawgrass Sublijet-HD 1KG Yellow	507184		88277693	93,18
Sawgrass Sublijet-HD 1KG Black XF	507181-XF		88277689	93,18
Sawgrass Sublijet-HD 1KG Light Cyan	507187		88277696	93,18
Sawgrass Sublijet-HD 1KG Light Magenta	507188		88277697	93,18
Sawgrass Sublijet-HD 1KG Light Black XF	507189-XF		88277698	93,18
Sawgrass Sublijet-HD 1KG Light Light Black XF	507185-XF		88277694	93,18
Sawgrass Sublijet-HD 1KG Cleaning	507180		88277667	54,09

## Current Epson Printers Supplies

Description	Ref. Supplier	Info	Ref. Papyrus	€
-------------	---------------	------	--------------	---

### Supplies for Epson SureColor SC-S80600

#### Epson UltraChrome GS3 Ink - 700 ml.

Epson UltraChrome GS3 Ink Cyan 700 ml	2514257		88307686	100,00
Epson UltraChrome GS3 Ink Magenta 700 ml	2514259		88307687	100,00
Epson UltraChrome GS3 Ink Yellow 700 ml	2514262		88307688	100,00
Epson UltraChrome GS3 Ink Black 700 ml	2514255		88307689	100,00
Epson UltraChrome GS3 Ink Light Cyan 700 ml	2577310		88307690	100,00
Epson UltraChrome GS3 Ink Light Magenta 700 ml	2577311		88307692	100,00
Epson UltraChrome GS3 Ink Light Black 700 ml	2577312		88307693	100,00
Epson UltraChrome GS3 Ink Red 700 ml	2577314		88307694	100,00
Epson UltraChrome GS3 Ink Orange 700 ml	2577313		88307695	100,00
Epson UltraChrome GS3 Ink White 600 ml	2577315		88307696	220,00
Epson UltraChrome GS3 Ink Silver 350 ml	2577316		88307697	245,00

### Supplies for Epson SureColor SC-S80600L

#### Epson UltraChrome GS3 Ink - 1,5l

Epson UltraChrome GS3 Ink Black 1.5 L	C13T45L100		88311924	172,00
Epson UltraChrome GS3 Ink Cyan 1.5 L	C13T45L200		88311927	172,00
Epson UltraChrome GS3 Ink Magenta 1.5 L	C13T45L300		88311928	172,00
Epson UltraChrome GS3 Ink Yellow 1.5 L	C13T45L400		88311929	172,00
Epson UltraChrome GS3 Ink Light Cyan 1.5 L	C13T45L500		88311930	172,00
Epson UltraChrome GS3 Ink Light Magenta 1.5 L	C13T45L600		88311931	172,00
Epson UltraChrome GS3 Ink Light Black 1.5 L	C13T45L700		88311932	172,00
Epson UltraChrome GS3 Ink Orange 1.5 L	C13T45L800		88311933	172,00
Epson UltraChrome GS3 Ink Red 1.5 L	C13T45L900		88311935	172,00
Epson UltraChrome GS3 Ink White 1.5 L	C13T45LA00		88311936	440,00
Epson UltraChrome GS3 Ink Silver 500 ml	C13T45LB00		88311937	350,00